

# RADIO-CRAFT

HUGO GERNSBACK, Editor

**"Her Master's Voice"  
— by Radio!  
See Page 73**

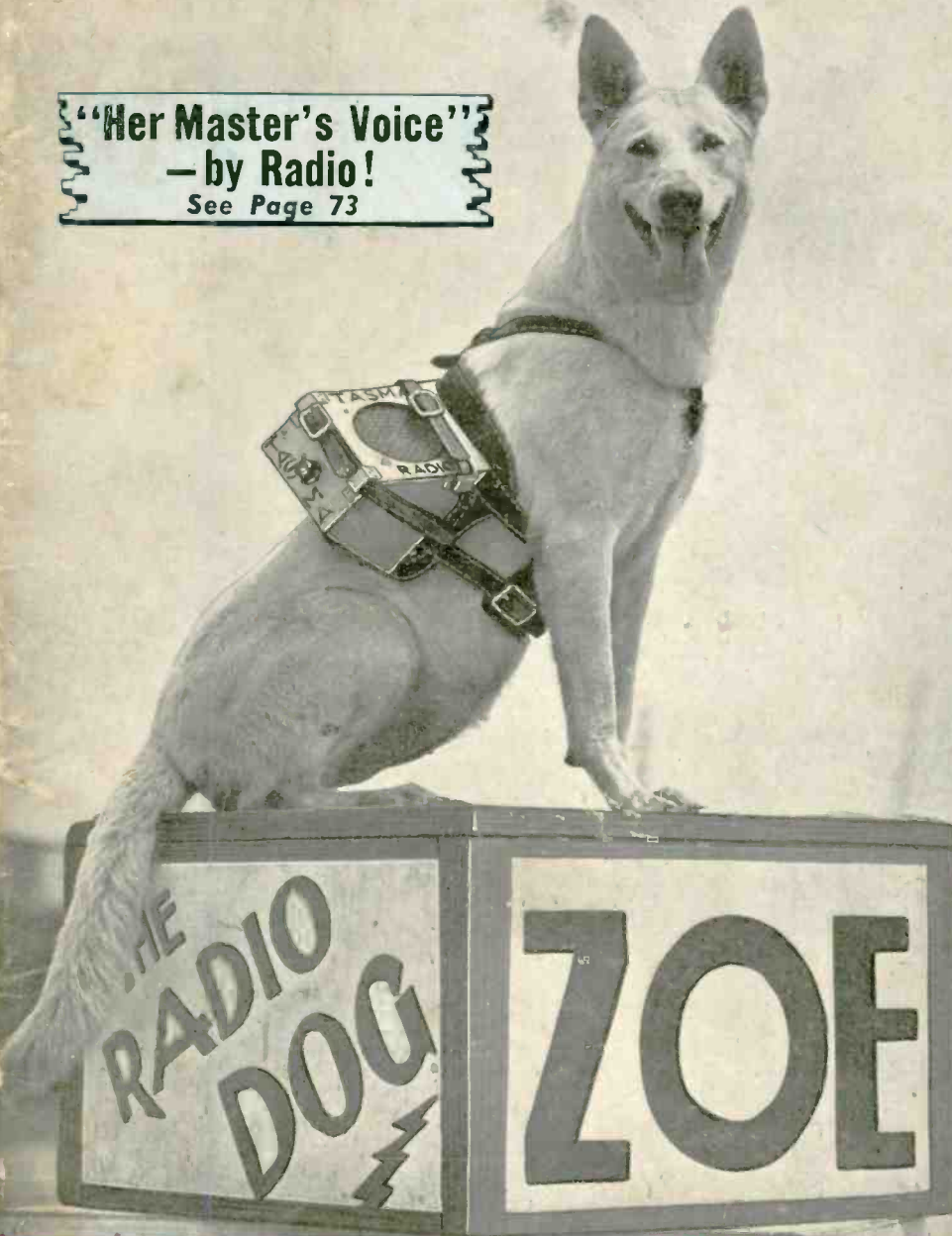

**AMATEUR TELEVISION**

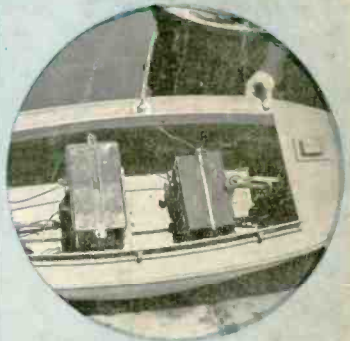

**RADIO-PILOTED BOAT**

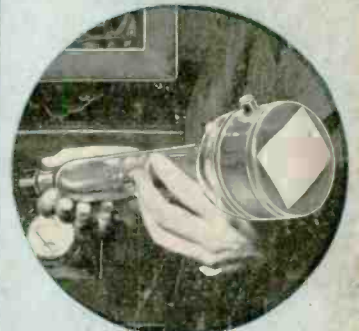

**SCREEN TELEVISION**



**A. F. CLOCK!**

**AUGUST  
25c**

**RADIO'S GREATEST MAGAZINE**

**BUILD AN F. M. ADAPTER • A CONSTANT-OUTPUT POWER SUPPLY  
SIGNAL TRACER • BOOSTER AMPLIFIER • REBUILDING FOR PROFIT**

**IN U. S. AND  
CANADA**



# Research is radio's road to progress

World wide radio communications; national and international broadcasting; radio usefulness in times of peace and in times of national emergency, are all the products of scientific research. Without such research, the American radio industry would be non-existent. Without it, radio's future usefulness would remain unexplored.

Radio research has been the keystone of RCA's operation since 1919. Today, this Company, which is engaged in every field of radio, is following its consistent policy of improving present-day radio services and pioneering in the development of the new.

Three new services in radio now beckon those who would expand radio's usefulness to the public and who would create employment of men and money. They are Facsimile, Frequency Modulation, and Television. Involved

in these three new services are the transmission of printed matter and illustrations; the improved transmission of sound services; and the transmission of sight and sound simultaneously through the air. In other words, new and important communication services are now out of the laboratory and ready for use in the interests of education and entertainment, and for the service of industry and commerce.

Research continues, however, to explore the unknown frontiers of space where additional useful radio channels may be created for a thousand and one additional services in the interest of mankind.

RCA continues with 600 research specialists at work constantly improving the old and developing the new. Radio's road to the future is the research road, the road to progress.



## Radio Corporation of America





# Be a RADIO Technician

Many make **\$30 \$40 \$50** a week

I will train you at home for many Good Spare Time and Full Time Radio Jobs

**J. E. SMITH, President, National Radio Institute**  
Established 25 Years  
He has directed the training of more men for the Radio Industry than anyone else.



**Set Servicing** pays many Radio Technicians \$30, \$40, \$50 a week. Others hold their regular jobs and make \$5 to \$10 extra a week in spare time.

**Broadcasting Stations** employ operators, installation, maintenance men and Radio Technicians in other capacities and pay well.



**Loudspeaker System** building, installing, servicing and operating is another growing field for well trained Radio Technicians.



## I Trained These Men



**\$10 to \$20 a Week in Spare Time**  
I repaired many Radio sets when I was in my tenth lesson. I really don't see how you can miss so much for such a small amount of money. I made \$600 in a year and a half, and I have made an average of \$10 to \$20 a week just spare time.  
**JOHN JERRY, 1529 Arapahoe St., Denver, Colo.**



**Makes \$50 to \$60 a Week**  
"I am making between \$50 and \$60 a week after all expenses are paid, and I am getting all the Radio work I can take care of, thanks to N. R. I." **H. W. Slinger, 126 1/2 S. Gay St., Knoxville, Tenn.**



**Operates Public Address System**  
"I have a position with the Los Angeles Civil Service, operating the Public Address System in the City Hall Council. My salary is \$170 a month." **H. H. Hood, R. 138, City Hall, Los Angeles, Calif.**

Radio is a young, growing field with a future. It offers many good pay spare time and full time job opportunities. And you don't have to give up your present job, go away from home, or spend a lot of money to become a Radio Technician. I train you at home nights in your spare time.

### Jobs Like These Go to Men Who Know Radio

Radio broadcasting stations employ Radio Technicians as engineers, operators, Maintenance Men and pay well for trained men. Radio manufacturers employ testers, inspectors, foremen, servicemen in good-pay jobs with opportunities for advancement. Radio jobbers and dealers employ installation and servicemen. Many Radio Technicians open their own Radio sales and repair businesses and make \$30, \$40, \$50 a week. Others hold their regular jobs and make \$5 to \$10 a week fixing Radios in spare time. Automobile, police, aviation, commercial Radio; loudspeaker systems, electronic devices, are newer fields offering good opportunities to qualified men. And my Course includes Television, which promises to open many good jobs soon.

### Why Many Radio Technicians Make \$30, \$40, \$50 a Week

Radio is already one of the country's large industries even though it is still young and growing. The arrival of Television, the use of Radio principles in industry, are but a few of many recent Radio developments. More than 28,000,000 homes have one or more Radios. There are more Radios than telephones. Every year millions of Radios go out of date and are replaced. Millions more need new tubes, repairs, etc. Over 5,000,000 auto Radios are in use and thousands more are being sold every day. In every branch Radio is offering more opportunities for which I give you the required knowledge of Radio at home in your spare time. Yes, the few hundred \$30, \$40, \$50 a week jobs of 20 years ago have grown to thousands.

### Many Make \$5 to \$10 a Week Extra in Spare Time While Learning

The day you enroll, in addition to my regular Course, I start sending you Extra Money Job

Sheets—start showing you how to do actual Radio repair jobs. Throughout your course I send plans and directions which have helped many make \$5 to \$10 a week in spare time while learning. I send special Radio equipment; show you how to conduct experiments, build circuits. My Course includes Television, too.

### I Give You This Professional Servicing Instrument



This instrument makes practically any test you will be called upon to make in Radio service work on both spare time and full time jobs. It can be used on the test bench, or carried along when out on calls. It measures A.C. and D.C. voltages

and currents; tests resistances; has a multi-band oscillator for aligning any set, old or new. You get this instrument to keep as part of your N. R. I. Course.

### Find Out How N. R. I. Teaches Radio and Television

Act today. Mail coupon now for Sample Lesson and 64-page Book. They're FREE. They point out Radio's spare time and full time opportunities and those coming in Television; tell about my course in Radio and Television; show more than 100 letters from men I trained, telling what they are doing and earning. Read my money back agreement. Find out what Radio offers you. Mail coupon in envelope or paste on penny postcard—NOW.

**J. E. SMITH, President, Dept. OHX, National Radio Institute Washington, D. C.**



**THIS FREE BOOK HAS HELPED HUNDREDS OF MEN MAKE MORE MONEY**

## Good for Both 64 PAGE BOOK SAMPLE LESSON FREE

**J. E. SMITH, President, Dept. OHX National Radio Institute, Washington, D. C.**

Without obligating me, mail your Sample Lesson and 64 page Book FREE. I am particularly interested in the branch of Radio checked below. (No salesman will call. Write plainly.)

<input type="checkbox"/> Radio Service Business of My Own	<input type="checkbox"/> Loudspeaker Systems, Installations and Service
<input type="checkbox"/> Service Technician for Retail Stores	<input type="checkbox"/> Auto Radio Installations and Service
<input type="checkbox"/> Spare Time Radio Repair Work	<input type="checkbox"/> Television Station Operator
<input type="checkbox"/> Broadcasting Station Operator	<input type="checkbox"/> All-around Servicing Technician

(If you have not decided which branch you prefer—mail coupon now, for information to help you decide.)

Name ..... Age .....

Address .....

City ..... State ..... **14X1**

## Sample Lesson Free

I want to prove our Course gives practical, money-making information, that it is easy to understand—what you need to master Radio. My sample lesson text, "Radio Receiver Troubles—Their Cause and Remedy," covers a long list of Radio receiver troubles in A.C., D.C., battery, universal, auto, T.R.F., super-heterodyne, all-wave, and other types of sets. And a cross reference system gives you the probable cause and a quick way to locate and remedy these set troubles. A special section is devoted to receiver check-up, alignment, balancing, neutralizing, testing. Get this lesson Free by mailing the coupon.

# RADIO-CRAFT

HUGO GERNSBACK, *Editor-in-Chief*

N. H. LESSEM  
*Associate Editor*

THOS. D. PENTZ  
*Art Director*

ROBERT EICHBERG  
*Trade Digest Editor*

R. D. WASHBURNE, *Managing Editor*

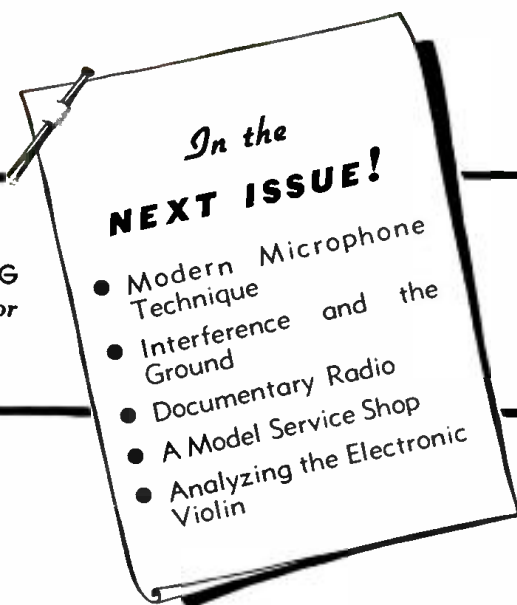

## Contents AUGUST, 1940 Issue

VOLUME XII -- NUMBER 2

Mailbag .....	67
Editorial: "The Serviceman's Follies" .....	Hugo Gernsback 71
The Radio Month in Review .....	72

### SERVICING

New Circuits in Modern Radio Receivers—No. 35 .....	F. L. Sprayberry 74
Replacing I.F. Transformers .....	L. V. Sorensen 75
Operating Notes .....	80
Rebuilding for Profit .....	Charles R. Leutz 81
Auto-Radio Installations on All 1940 Passenger Cars .....	Edward H. Barry 86
Fix That Radio .....	Willard Moody 89
RADIO SERVICE DATA SHEETS:	
No. 282—Sentinel Model 217-P Portable Radio Set .....	90
No. 283—Belmont Model 678 Auto-Radio Set .....	91

### TEST INSTRUMENTS

A Low-Cost Signal Chaser—Plus .....	C. Rask Latimer 93
-------------------------------------	--------------------

### SOUND

Improved Reflex Speaker .....	R. C. Reinhardt 96
Constant Groove-Speed Recording .....	E. E. Griffin 98
Sound Engineering—No. 8 .....	101
20-Watt Booster Amplifier for Radio Receivers, Low-Power P.A. Systems, Etc. ....	H. T. Ziegler 103

### TELEVISION

Newest Screen-Size Television .....	105
-------------------------------------	-----

### ENGINEERING

The Fundamentals of Constant-Output D.C. Power Supplies .....	A. C. Shaney 106
What Causes Echo, Fading, Etc.? .....	108

### EXPERIMENTERS

Build This Practical F.M. Adapter .....	Arthur H. Lynch 110
---	---------------------

### RADIO DEVELOPMENTS

An A.F. Clock! Musical Time Standard .....	112
Radio-Controlled Boat .....	112
Dual-Coaxial Speaker .....	113

### DEPARTMENTS, ETC.

Mailbag .....	67
The Radio Month in Review .....	72
New Circuits in Modern Radio Receivers .....	F. L. Sprayberry 74
Broadcast News Items .....	79
Operating Notes .....	80
RADIO SERVICE DATA SHEETS (see Servicing) .....	90, 91
Book Reviews .....	95, 100, 128
Sound Engineering—No. 8 .....	101
Latest Radio Apparatus .....	114
Some Recent Engineering Developments .....	121
Radio Trade Digest .....	123
Shop Notes—Kinks—Circuits .....	127
"Weather 6" Girls Get "Tutor" Records .....	127

★

Published by Radcraft Publications, Inc. Publication office: 29 Worthington Street, Springfield, Mass. Editorial and Advertising Offices: 20 Vesey Street, New York City. Chicago Advertising Office: RADIO-CRAFT, 520 North Michigan Avenue, Chicago, Ill.

RADIO-CRAFT is published monthly, on the first of the month preceding that of date; subscription price is \$2.00 per year in U. S. and Canada. (In foreign countries, \$2.50 a year to cover additional postage.) Entered at the post office at Springfield as second-class matter under the act of March 3, 1879.

★

Foreign Agents:

London—Gorrings' American News Agency, 9A Green St., Leicester Square, W. C. 2, England.  
Paris—Messageries Dawson, 4 Rue Faubourg, Poissonniere, France.  
Melbourne—McGill's Agency, 179 Elizabeth St., Australia.  
Dunedin—James Johnston, Ltd., New Zealand.

★

Text and illustrations of this magazine are copyright and must not be reproduced without permission of the copyright owners.

★

Copyright 1940 Radcraft Publications, Inc.



Why Should New Men  
Get the New Jobs?  
**INSURE YOUR  
FUTURE!**



**Start Training Now for a Better Job**

Do you ever sit down and "look your job in the face"? Radio plays no favorites... the GOOD men get the GOOD jobs. Right now is the time to equip yourself with the technical training that will qualify you for the many new opportunities in broadcasting, frequency modulation, facsimile and television. The fact that men in more than 300 broadcasting stations selected CREI training is evidence that it pays dividends in better jobs and more money. CREI training in Practical Radio and Television Engineering is available in home-study and residence courses. Let us suggest the course best suited for you to keep pace with Radio.

**Write for FREE Book of "A Tested Plan"**

To enable us to send you complete information, please state briefly your radio experience, education and present position—and whether you are interested in home-study or residence training.



**CAPITOL RADIO  
Engineering Institute**

Dept. RC-3, 3224 16th Street, N. W., Washington, D. C.

**NOW!**

The Greatest and most important formula book in print. It contains over 10,000 trade secrets, recipes and formulas for home, farm and workshop.

Chock-full of money-making ideas for cosmetics, soap, perfumes, antiseptics, water-proofing, photography, lacquer, paints, cement, preservatives, fumigants, insecticides, etc.

Book also contains following: important chapters: Useful Workshop Laboratory Methods, fully illustrated. Complete Buyer's Guide, where to buy materials at wholesale prices; Measuring Made Easy; Latin Names of Drugs and Chemicals Translated into English. Completely indexed. In short, this is a Wonder Book of Useful Knowledge! Worth its weight in gold.

Book is up-to-date and has the newest methods—latest discoveries—countless thousands of ideas—which you will find useful. Remember—these are actually over 10,000 clearly described formulas, processes, recipes—MANY NEVER BEFORE REVEALED.

This huge book has 924 pages, printed on good paper. Size is 8 1/2" x 5 1/2".

Send for a copy of this veritable gold mine TODAY. You will never regret it. Remember, great fortunes are often made on formulas.

\$1.00 per copy. Postage in U. S. 10c extra. (Canada and foreign countries 25c extra for post.)  
Send money order, check, unused U.S. stamps or cash. (Register all letters containing cash.)

**\$1.00**

**NATIONAL PLANS INSTITUTE**  
246-R Fifth Avenue New York, N. Y.

**LES Correspondence Courses in  
RADIO and ELECTRICAL ENGINEERING**

**ELECTRICAL ENGINEERING** Get good grasp practical field. Prepare yourself, at Low Cost, for secure future. Modern, simplified, you can understand quickly.

**RADIO ENGINEERING** Extra fine course in radio, public address, photo-electric work.

Trains you to be super-service man, real vacuum tube technician. Exper. kits furnished. Diploma on completion. Tuition, \$25 either course. Deferred payment plan.

**FREE** Get copies of school catalogs, student magazines, complete details. SEND NOW!

LINCOLN ENGINEERING SCHOOL, Box 931-C20, LINCOLN, NEBR.

**RADIO COURSES**  
Start September

- RADIO OPERATING—BROADCASTING
- RADIO SERVICING — a practical course
- RADIO AMATEUR CODES • TELEVISION
- ELECTRONICS—1 yr. day course 2 yrs. eve.

Day and Evening Classes. Booklet Upon Request.  
New York Y.M.C.A. Schools  
4 W. 84th Street New York City

**"DIRECT-COUPLED 10-W.  
AMPLIFIER"—REVISED**

Dear Editor:

● IN reference to the article, "How to Design an Inexpensive All-Push-Pull Direct-Coupled 10-Watt Amplifier" in the July, 1939, issue of the *Radio-Craft* magazine, I would like to know from Mr. A. Shaney if it were possible to build the same amplifier with 2—2A3 tubes in the output stage, and a 53 in the driver stage according to the diagram as published. Of course, some changes must be made in the values of the resistors, and I would like to know what values would be used in place of those listed for the tubes as designed. I do not quite understand how you have calculated the values as they are prescribed in the article, as my RCA tube manual does not give similar plate and screen-grid currents for the 6SJ7 tubes as you specify in the article, i.e., 1.5 ma. and 0.5-ma., respectively, etc. The ratings I read are higher. Nevertheless, I would like to use the 2.5 volts I have at hand, and would like to know if it is possible, or feasible, and how it may be done.

PAUL E. HOLLIS,  
Baltimore, Md.

This letter was forwarded to Mr. A. C. Shaney, whose reply follows:

Dear Mr. Hollis:  
Your inquiry addressed to *Radio-Craft*, has been referred to me for reply.

It is quite possible to design a 2—2A3 Direct-Coupled Amplifier. The use of the 53 driver, however, is not recommended.

An amplifier of this type is scheduled to appear in the August, 1940, issue (on newsstands July 1).

The values used for the basis of calculating the resistances in the Direct-Coupled Amplifier, utilizing 6SJ7 tubes, were obtained by connecting up a tube with the applied potentials and then measuring the currents in plate, screen-grid, and cathode circuits.

A. C. SHANEY.

**NEW ZEALAND SERVICEMAN  
ANALYZES US**

Dear Editor:

● While looking through your November, 1939 issue of *Radio-Craft* I noticed in the "Mailbag" some opinions. One agrees, another differs with Mr. Moody; well, I am not going to say which is correct. They both have their faults and a magazine like yours serves not only one class of Serviceman but hundreds. I like Mr. Sprayberry's articles and read them diligently. I have to say if I want to know all the trick circuits that come out, and although I may never come across one in a year, it improves my mentality for puzzling out those that I do come across and which I cannot find in my publications.

The Service Questions & Answers no doubt had good intentions when it started out but such a section always has the tendency to lead to the asking of a lot of stupid questions; by this I do not mean that all the questions are stupid. Also I do not agree with Bob Stetler who thinks they are mostly screwdriver mechanics. If the position in America is the same as it is here you find that certain areas have a predominance of one make of set and the Serviceman may run into trouble if he runs up against an orphan.

Against this, any man who can wait probably a whole month for the answer to come in your publication, cannot be so hot. He could tear the set to pieces and test each part a dozen times and probably find it long before he got the answer. (That

**YOU CAN BECOME A MONEY-MAKING RADIO EXPERT**  
WITH THE **New SPRAYBERRY**  
Personalized  
**HOME TRAINING in RADIO**  
and TELEVISION



You Learn Easily in Your Spare Hours... By Doing Many Experiments with Up-To-Date Equipment

Here's a really fine, up-to-the-minute Radio and Television Training that's specially designed to give you quick results. TRAINING PREPARES YOU FOR GOOD RADIO JOBS... AT EXCELLENT PAY. My training starts right at the beginning of Radio... unfolds each subject in a simplified, logical, understandable style. You easily learn Television, Electronics, Facsimile Radio, Radio Set Repair and Installation Work, etc.

**NO PREVIOUS EXPERIENCE NEEDED**  
It makes no difference what your education has been. I can fit you for a good-paying Radio job. Your success is my full responsibility.

**YOU GET PRACTICAL TEST EQUIPMENT PLUS EXPERIMENTAL OUTFITS**

Includes 146 Radio Parts (to build complete Receiver), Tools, All-Wave, All-Purpose Analyzer, and Experimental Outfits for conducting actual experiments with your own hands.

**I Supply**  
My **BUSINESS BUILDERS** show you how to put your equipment to practical use in handling actual money-making Radio Service Jobs shortly after you begin training.

**SERVICEMEN**  
I offer Advanced Training for those already in Radio. Get complete details in my FREE 52-page Book, *The Sprayberry Course is Sold Under a Money-back Agreement*

**RUSH COUPON FOR BIG FREE BOOK**

**SPRAYBERRY ACADEMY OF RADIO**  
E. L. Sprayberry, Pres.  
320-W University Place, N.W., Washington, D. C.

Please send me FREE copy of "HOW TO MAKE MONEY IN RADIO."

Name ..... Age .....

Address .....

City ..... State .....

Tear off this coupon, mail in envelope or paste on penny postcard. Servicemen—Check here

**RADIO plus  
TELEVISION** — mastered by pre-tested Training

No matter where you are or what you do, National has a complete training plan for you—to fit your circumstances. National's plan is for those seeking immediate shop-training as well as for those who cannot give up present employment and income. Mail coupon below for FREE literature.

**NATIONAL SCHOOLS**

NATIONAL SCHOOLS, Dept. RC-3  
4000 So. Figueroa St., Los Angeles, Calif.

Please send free literature and full details.

NAME ..... AGE .....

ADDRESS .....

CITY ..... STATE .....

**Be a RADIO SERVICE EXPERT  
LEARN AT HOME IN SPARE TIME**

Clear, simple, fascinating lessons—practical work with experimental kits—make training easy and fast. Up to date R.T.A. methods. Enter personal guidance of prominent engineer and educator, highly endorsed by leaders in radio industry. Spare-time profits soon pay for training.

**START NOW** — have your own business or fit yourself for well paid work with radio dealers, in factories, police, marine or television fields. DON'T DELAY!  
Send AT ONCE for complete information and BIG Opportunity **BOOK FREE!**

**RADIO TRAINING ASS'N. OF AMERICA**  
4525 Ravenswood Ave. Dept. RC-80 Chicago, Ill.

**RADIO TECHNOLOGY**

RCA Institutes offer an intensive course of high standard embracing all phases of Radio and Television. Practical training with modern equipment at New York and Chicago schools. Also specialized courses and Home Study Courses under "No obligation" plan. Catalog Dept. RC-40.

**RCA INSTITUTES, Inc.**  
A Radio Corporation of America Service  
75 Varick St., New York, 1154 Merchandise Mart, Chicago



# Learn RADIO and SERVICE WORK with Ghirardi's BIG 3

## RADIO PHYSICS COURSE

### BASIC FUNDAMENTALS

Here's your start in Radio! If you are a beginner, this one big, all-inclusive, short-cut self-instruction book of nearly 1,000 pages with over 500 illustrations will give you a thorough training in the important Fundamentals of Radio, including Sound, Television, Cathode-Ray Tubes, etc.—all the essentials, all the background you need for a complete radio knowledge. No math—no previous training necessary. And you can learn it all easily by yourself at home, checking your progress with the 856 self-examination Review Questions. Ghirardi makes everything crystal-clear and easy to understand. That's why this same Radio Physics Course is used and highly praised by more radio schools and students than any other radio text in the world!

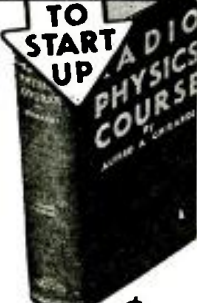

972 PAGES \$4  
508 ILLUS.  
856 REVIEW QUESTIONS

## MODERN Radio SERVICING

### LEARN HOW with this!

This famous Ghirardi text gives you a complete 1300-page training course in practical radio service work. It's an illustrated "gold mine" of servicing knowledge, starting with a thorough 420-page treatment of servicing instruments and continuing with nearly 900 more pages of a complete step-by-step procedure course in trouble-shooting, testing, aligning and repairing all makes of sets—all based on practical experience. Here's what you learn:

- Test Equipment — Theory, Descriptions, Diagrams of all Commercial Instruments, How They Work, Construction Data.
- Trouble-Shooting — Newest short-cut methods for all sets.
- Repairing—Advanced "Factory Methods" explained fully.



1300 PAGES \$4  
708 ILLUS.

## RADIO Trouble-Shooter's HANDBOOK

### WORK with this!

Every page of this big Ghirardi Handbook is crammed full of vital factory-checked servicing reference data urgently needed by every service man. Regardless of make and model of set, and what the Trouble is, this Handbook will speed up the repair. Used daily by thousands of smart service men. Contains—

- 3,313 Case Histories—Trouble Symptoms and Remedies for 3,313 models of receivers most frequently serviced.
- I-F Peaks—Alignment Data for over 15,000 Superhets.
- Other Data — Auto-radio, Install. and Service Data; Noise Elimination; Servicing Home Recorders and Intercommunications; and 40 more sections of data tables and charts.



518 Pages 134 Illus. \$3

### MAIL COUPON TODAY!

RADIO & TECHNICAL PUBL. CO., Dept. RC-80  
45 Astor York City

Send postpaid, with 5-Day Money Back Guarantee:

RADIO PHYSICS COURSE \$4. (\$4.50 foreign)

MODERN RADIO SERVICING \$4. (\$4.50 foreign)

RADIO TROUBLE-SHOOTER'S HANDBOOK \$3. (\$3.50 foreign)

BOTH SERVICING BOOKS at Special Combination Price \$6.50 (\$7 foreign)

Name \_\_\_\_\_

Address \_\_\_\_\_

City \_\_\_\_\_ State \_\_\_\_\_

Please send FREE illustrated descriptive literature.

**MONEY BACK IF NOT SATISFIED**

isn't quite the story, Mr. Carlisle. Answers go directly to inquirers by mail, at once, but certain of these questions and answers later are published in *Radio-Craft*.—*Editor*)

The Radio Kinks are quite interesting, but only for experimenters in most cases unless one wants to rig up something to use for a special job and tear it down again when finished as some of them do not meet the standard requirements for a permanent job or would be unwieldy with a lot of unnecessary controls or gadgets.

The data and articles on the construction of service equipment I think are extremely good and I would like to see a lot more of them. In this part of the world we do not have the variety of instruments to choose from and they are a great help to us in determining which type of instrument is best for the job and in some cases where constructional details are available I have made quite a number of useful instruments which I should otherwise have had to do without, owing to the cost not being warranted by the amount of business or the amount of work for such instruments, and these have saved me quite a lot of guess-work and headaches.

The section dealing with the latest equipment, etc., is a fine section and I think it gives us Servicemen who are in the remote corners of the earth an idea of what is going on and what is available.

I have had your magazine since 1933 and I was very sorry to see you change the cover style with the month and date on the back. However, I still think it is the best available. (Thank you!—*Ed.*)

L. F. CARLISLE,  
Putaruru, New Zealand.

### SIGNAL SERVICING

Dear Editor:

ON Page 477 of the February issue of *Radio-Craft*, under "Useful Kinks & Circuits," J. C. Ravelle has a Signal Servicing hookup. I have hooked this up but it won't deliver any signal in my phones.

Could you enlighten me as to whether you believe such a device is practical?

When I connect the device to ground, and probe to grid or plate of tube, all it does is ground the signal to the speaker (?) of the set and no signal can be heard in phones.

A. SINGLETON,  
Chicopee, Mass.

This letter was forwarded to author J. C. Ravelle whose reply appears below.

Dear Mr. Singleton:

By this time, no doubt, you have this "device" working and are getting as much satisfaction out of it as I am. However, I object to the second paragraph of your letter—after all, this device is merely a triode detector and as such has given results in radio for over 20 years. After this bit of

gentle razzing, let me see if I can help you.

The wire from the grid-condenser must not run through the probe but *must* be attached at one end, leaving 5 or 6 inches of the probe free, so that there won't be any hand-capacity to short your grid action. The probe, of course, must be of insulating material. The gridlead must not be across the grid-condenser, but from grid to ground.

When testing grid circuits in the radio-frequency end of the set, it is best to detach the grid lead from the control-grid cap of the tube. Do not expect stations to come exactly on frequency on dial because of the large capacity introduced by the long grid wire of the probe. Remember you are merely trying to see if there is life there.

What makes this device work, of course, is voltage variations. These can be high frequency or audio frequency. Thus, if you have a local station tuned-in you can test the R.F. section as well as the audio or output section of the receiver. When a set is working properly, you should hear the music on any grid or plate of any tube (excluding the rectifier) in the set. That is how you can tell that R.F. coils, tuning condensers, I.F. coils and trimmers, plate resistors, both ends of push-pull transformers, etc., are intact. Naturally you should hear nothing at the cathodes, screen-grids and the filaments. You should hear the raw 60-cycle A.C. at the rectifier. I should say, rather, that it is 60-cycle pulsating D.C. But the "B+" line should be quiet in all sets, except the small A.C.-D.C. jobs which produce "music" even on the "B+" line because practically all the current is taken by the output tube and the "B+" varies according to the music.

J. C. RAVELLE,  
Newark, N. J.

### SERVICE Q. & A. HELPED HIM

Dear Editor:

AFTER reading your monthly magazine *Radio-Craft* for more years than I care to remember it gives me a great deal of pleasure to write you.

In your March issue under Servicing Questions & Answers, please refer to question No. 151 concerning a Bush & Lane T.R.F. set.

I have encountered the same difficulty in a G.E. set model No. 77, and while the ground condition was a good mechanical job it was a failure electrically; and further, in addition to the hum mentioned a considerable amount of static prevented the correct operation of this set. A considerable amount of fine, white sand prevented a good ground condition. The writer has been servicing G.E. sets for a few years.

J. HOUGHTON,  
Peterborough, Ont., Can.

Let's have some good articles on Cathode Modulation

**BALTIMORE, MD., U.S.A.**

BIRTHPLACE OF THE STAR SPANGLED BANNER

# W3HDT

Radio-Craft..... 6c Sign. Page 440—Feb. Issue

At..... M.E.S.T. 193. QRG

Xmtg 6LE6X 45Watts 1934..... From Sky Chief

DX..... 86ft. Doublet

Remarks.....

R. F. WOLFE Pse Qst 2506 E. Hoffman St.

for DX-47 SATE

DEPLORES OMISSION OF "OPERATING NOTES"

Dear Editor:  
 ● I NOTICED in the March issue of *Radio-Craft* that you left out the Operating Notes section. I would like to see a bigger Operating Notes and Servicing Questions & Answers section, and less of the Radio Trade Digest. I have almost all of the *Radio-Craft* issues published.

S. PINDROH,  
 Pittsburgh, Pa.

Dear Mr. Pindroh:

We wonder whether you ever sent us any operating notes. We can't keep a department of this nature going without reader support. Send us your operating notes and tell your Servicemen pals to do likewise—we're always glad to publish them if they're considered helpful to others.—  
 Editor

RADIO-CRAFT FOR THE SERVICEMEN

Dear Editor:  
 ● I HAVE been reading *Radio-Craft* for some time and for the last year or so have been a regular subscriber. Your catering to the Serviceman's angle of the industry is our idea of making a better mag. If you have articles which aid the Serviceman they help him make more money and he will, therefore, wish to continue with you. Something which, in the end, makes the cash register ring—and that is what counts. Articles for the Amateur make it ring but for money he's taking out for new parts or a new rig you've told him about.

CECIL G. HARTNESS,  
 Hartness Radio Service,  
 Mineral Bluffs, Ga.

WANTS V.-T. VOLTMETER CIRCUIT

Dear Editor:  
 ● IN your January issue of *Radio-Craft* I was very interested in Roy Powell's letter regarding the home-made instruments, and especially, the V.-T. voltmeter. Would you please publish a circuit on a vacuum-tube voltmeter operating from the line voltage of 110 volts A.C.-D.C. using a 25Z5 and a 6J5 having an input of 15 megs., and having ranges up to 1,000 volts.

I started reading *Radio-Craft* about 6 months ago so I have missed many of your construction articles. From now on I will be a constant reader of your magazine.

DENIS DAVIES,  
 Nanaimo, B. C.

DISLIKES RADIO-CRAFT'S NEW BINDING

Dear Editor:  
 ● I HAVE been a regular reader of your magazine ever since it was known as the *Electrical Experimenter* and can truthfully say that I get more good out of *Radio-Craft*, than out of the other 3 radio magazines, combined, that I read.

And whenever I have a radio service problem or need a diagram I can be sure to find what I need in my *Radio-Craft* files.

My preference of the articles in the magazines is the Operating Notes, Useful Kinks & Circuits, and constructional articles on radio and test equipment.

One thing I don't like about the magazine is the new binder. It is not as easy to file the magazines as with the old binder.

Incidentally, the fewer ham articles you have in the magazine the better I will like it.

THOS. R. DISSINGER,  
 Chicago, Ill.

**SENSATIONAL NEW**  
**SCOTT**  
*Frequency Modulation*  
**RADIO**

UTTERLY NEW! STRANGELY AND BEAUTIFULLY UNLIKE ANY RADIO RECEPTION YOU HAVE EVER HEARD

**FREQUENCY MODULATION** . . . the sensational new and entirely different system of radio broadcasting and reception . . . has been approved and declared "highly perfected" by the Federal Communications Commission. It is generally predicted that some 1000 new F.M. transmitters will be installed at an early date. More than 20 are already in full operation. A completely new type of receiver is required for this amazing new Frequency Modulation reception! Always far ahead, Mr. E. H. Scott has developed a magnificent new SCOTT custom built F.M. Receiver which is causing a sensation. It creates a perfection in radio reception far above any the world has ever known!

of the F.M. transmitter. In fact, the most favorable conditions for demonstrating are in the midst of a crashing electrical storm, where the ordinary radio is rendered useless! During pauses between programs or stations there is nothing but deep silence . . . only the dial lights tell you the current is on.

**TONE UNEQUALLED IN RADIO HISTORY**  
 Tone is so utterly realistic it is practically impossible to tell the difference between the original sound and SCOTT F.M. reproduction.

**BE FIRST TO OWN THE F.M. SCOTT**  
 Don't wait. Be among the first to own this sensational new home entertainment. The custom built SCOTT is now ready to receive the new Frequency Modulation programs on the new F.M. wave band allotted by the government. ONLY the SCOTT gives a 5-year guarantee and custom builds to order, with infinite precision. Newest SCOTT offers local broadcast, short wave, and F.M. reception all on one chassis!

NO STATIC—NO INTERFERENCE—NO "NOISE"!

Frequency modulation reception by the remarkable new custom built SCOTT is incredibly beautiful . . . like a dream come true! NO STATIC, no interference, no "noise" can be heard within the service area

Mail The Coupon Now — Get Money Saving Introductory Offer

**E. H. SCOTT RADIO LABORATORIES, INC.**  
 4404 RAVENSWOOD AVE., DEPT. 24N40, CHICAGO, ILL.

Send all facts, special offer, analysis of Scott receivers, and order blank. NO obligation.

Name \_\_\_\_\_  
 Address \_\_\_\_\_

STUDIOS:  
 CHICAGO, NEW YORK, BUFFALO, DETROIT, LOS ANGELES

LIKES "R.-C." AS IS

Dear Editor:  
 ● AS a steady reader of *Radio-Craft* I wish to inform you that I find the articles written by Charles R. Leutz very instructive and interesting, and look forward to reading many more articles written by him.

Also wish to add that the article written by H. S. Manney in the April issue was fine, and would like to read many more.

I find *Radio-Craft* magazine a good all-around periodical, and recommend it to my friends.

Hoping you keep *Radio-Craft* in its present form, I remain

I. L. FRIEDMAN,  
 Brooklyn, N. Y.

Your comments are appreciated. Mr. Friedman—especially that part about recommending "R.-C." to your friends!—  
 Editor

V.-T. VOLTMETER ARTICLE GOES OVER BIG

Dear Editor:  
 ● MAY we take this opportunity to compliment you on the most excellent article appearing in June "R.-C.", pg. 726, by Mr. Rufus Turner on the Universal Direct-Reading Vacuum-Tube Voltmeter.

This instrument meets exactly, and fills, a long-felt want among constructors and Servicemen.

The circuit is so well engineered and the constructional data so exceptionally well written that this most useful unit will undoubtedly become an immediate addition to the equipment of many grateful subscribers to your splendid publication.

S. I. WELLS,  
 Wells Bros. Amusement Co.,  
 Toronto, Ont., Can.



Order your copy NOW—the only

# P. A. HANDBOOK

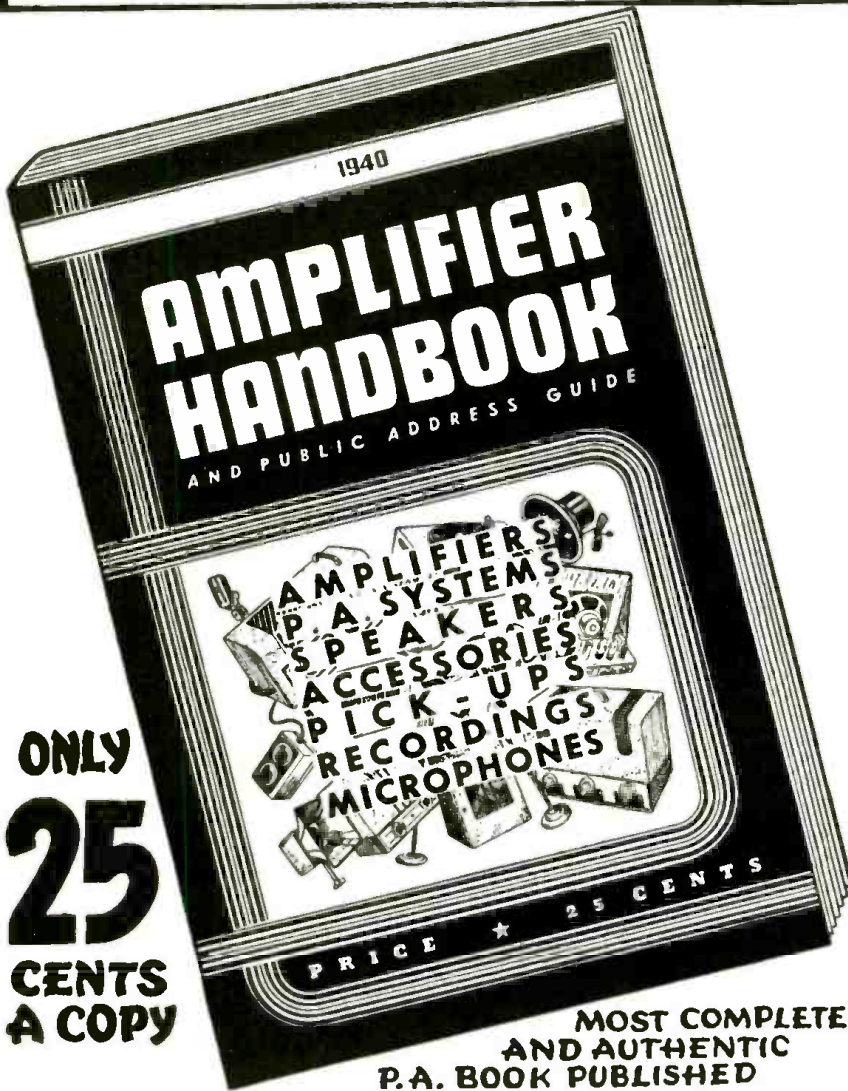

ONLY  
**25**  
CENTS  
A COPY

THAT no book has yet been published which covers amplifiers and sound systems (also kindred systems) in one complete, authentic volume is almost unbelievable. Yet, it is a fact, there is no book in print which covers Public Address from A to Z. To bridge this wide-spread gap, RADIO-CRAFT will publish a complete, magnificent volume on Public Address of such magnitude—so complete and authoritative—that every man engaged in radio can have both a theoretical and practical knowledge of the function and operation of sound systems. The editorial pages are so filled with instruction and replete with illustrations that the volume fully justifies its title of 1940 AMPLIFIER HANDBOOK AND PUBLIC ADDRESS GUIDE. This great HANDBOOK on Public Address should be read and studied by those who consistently build, service and sell sound equipment.

#### A MATCHLESS VOLUME

As complete as you would expect to find any engineering handbook—this is how the radio or P. A. man finds the AMPLIFIER HANDBOOK AND PUBLIC ADDRESS GUIDE. With essential technical data compiled from an exceptionally large number of sources, the volume covers nearly a hundred different subjects coordinating every conceivable branch or sub-division of Public Address.

#### THE CONTENTS

To actually show the scope and magnitude of the AMPLIFIER HANDBOOK AND PUBLIC ADDRESS GUIDE, an analysis of the contents is found at the right, showing the breakdown of the material featured within each particular section. A thorough reading of the contents shows the completeness of this book.

RADCRAFT PUBLICATIONS ■ 20 VESEY STREET ■ NEW YORK, N. Y.

RADCRAFT PUBLICATIONS, INC. ★ 20 VESEY STREET ★ NEW YORK, N. Y. RC-840

Gentlemen: Enclosed find my remittance of 25c for which send me POSTPAID, one copy of your NEW—1940 AMPLIFIER HANDBOOK AND PUBLIC ADDRESS GUIDE.

Send me ..... others, for friends, also POSTPAID @ 25c each.

Name ..... Address .....

City ..... State .....

Remit by check or money order; register letter if you send cash or unused U.S. Postage Stamps.

### We Apologize for the Delay in Delivery:—

Due to editorial circumstances beyond our control, the Amplifier Handbook will be ready about July 15th.

### A Resume of the Contents of the AMPLIFIER HANDBOOK AND PUBLIC ADDRESS GUIDE

#### FOREWORD

#### INTRODUCTION

Definitions—decibels, frequency, input, output, impedance, etc.

#### SECTION I—SOURCE

Carbon microphones (single-button and double-button)

Condenser microphones

Velocity (ribbon) microphones

Dynamic microphones

Crystal microphones (sound-cell types, crystal diaphragm types)

Cardioid microphones

Contact microphones

Phonograph pickups (magnetic types, crystal types)

#### SECTION II—AMPLIFIERS

##### Voltage Amplification

Design of resistance-coupled voltage amplifiers

Commercial voltage amplifier

##### The Power Stage

Class A amplifiers

Class AB amplifiers

Class AB<sub>1</sub> amplifiers

Class AB<sub>2</sub> amplifiers

Class B amplifiers

When to apply class A, AB, and B amplification

##### Power Supplies

Half-wave rectification

Full-wave rectification

Voltage doublers

##### Filter Circuits

Power supply regulation, etc.

##### Practical Hints on Amplifier Construction

Microphonism

Placement of components

Tone compensation

Inverse feedback

Remote control methods

#### SECTION III—DISTRIBUTION

##### The Loudspeaker

Dynamic speakers

Speaker performance (frequency response, efficiency)

High-fidelity speakers

##### Speaker Baffles and Housings

Outdoor speaker installations

Power cone speakers

Radial (360° distribution) speaker baffles

#### SECTION IV—COORDINATION

Input impedance matching

Matching speakers to P.A. installations

Phasing speakers

Effect of mismatching speakers to amplifier output

A typical P.A. installation (in a skating rink)

#### SECTION V—USEFUL, PUBLIC ADDRESS DATA AND INFORMATION

Speaker matching technique

The ABC of Db., VU, Mu, Gm and Sm

Charts and formulas useful to the practical P.A. sound man

Handy index to important articles on public address and sound

Order Your Copy NOW—

Clip Coupon and  
Mail Today!



# RADIO-CRAFT

"RADIO'S GREATEST MAGAZINE"

...."dub" Servicemen can never understand why the successful ones succeed.

## "THE SERVICEMAN'S FOLLIES"

By the Editor — HUGO GERNSBACH

**Y**OU are lying on your sick bed, racked with pain; your eyesight doesn't function; you cannot move your legs and your digestion is just about completely gone. In short, as far as everyone is concerned, you have ceased to function normally.

In order to get back into circulation once more, you remember a certain doctor and you ask the wife to call him up. You are a cautious man, however, so you instruct your wife to find out how much he will charge for the call. She informs you that the "Doc" will charge 50c for the call. This information surprises you and you immediately jump to the conclusion that he must be a cheap quack and you certainly will not put yourself into the hands of such a man. Your wife then suggests that you call up a specialist of whom she has heard. You agree with this quickly and the telephone call is made. This time the doctor, who is too busy to answer calls himself, does not come to the phone but the nurse answers instead. "Yes, the doctor can come over in the afternoon and his fee for such a call is \$20." This strikes you as more in line with your own importance and you ask the doctor to come as fast as he can.

Nothing unusual about all this and it happens hundreds of times all over the land every day, and whether the patient is a human being or a radio set makes little difference in the psychology of human beings. It is usually a matter of confidence. Believe it or not—the majority of the Servicemen will not get this simple fact into their heads; and that is the reason why we have 50c-a-call Servicemen—the quacks in the radio service field.

I have made it a point to tell the above parable, simply because the truth of it is not always apparent, which is the reason that thousands of Servicemen bemoan their fate when they cannot make a living.

I know that this will bring an outburst from many Servicemen who will write me indignant letters that I know nothing about servicing and that I only generalize. What these Servicemen seem to forget, however, is that we are in constant contact with hundreds of Servicemen right along. We see and speak to them, not only locally, but in our wanderings around the country, and therefore know their problems. Then, quite frequently, we have visiting Servicemen from out of town and—believe it or not—many of them do come here. Particularly last year and this year, they came, and are coming, in droves to see the New York World's Fair. Yes, and—the doubting Thomases notwithstanding—they stay here for a week at a time and spend quite a bit of money, too. On the other hand, that type of Serviceman is the successful species—the type who actually makes money—real money.

All this brings me to the instance of a visiting Ohio radio Serviceman who called on us last month. Usually we cannot afford to spend too much time with them, but when—let us call him Mr. G.O.Getter—came in, we spent over one hour and a half with him and, as usual, when we talk to a first-class Serviceman of his type, we absorb much knowledge.

Mr. G.O.Getter appears to be a man of acumen and, to boot, a mighty successful radio Serviceman. He has been so successful in his community that he is now erecting a good-size brick and steel building, made from the profits of his business, which comprises public address systems, stage lighting and talking picture equipment. Mr. G.O.Getter feels sorry for and pities the "dub" type of Servicemen and has naught but contempt for them. He maintains that the greatest trouble with them is that—first, they are not salesmen; second, they invariably employ the wrong psychology when talking to their prospects; and third, they are

extremely poor businessmen. Usually, as Mr. G.O.Getter puts it, "They don't know what it's all about. They are lucky if they make \$20 to \$30 a week and a large percentage of them do not even average this much."

My visitor then gave me an example which I really believe is a classic and one which every Serviceman should read carefully.

It appears that in the city in which G.O.Getter lives there is a large hall in which a public address system is installed. Not so long ago, the system became out of order and the proprietors of the hall asked for bids to put it into good repair. A number of bids were received. Mr. G.O.Getter, as usual, got the order. A few days thereafter a local Serviceman—let us call him Mr. P.E.Ewee—called upon Mr. G.O.Getter complaining bitterly that G.O.Getter must have underbid him, otherwise how could he have gotten the order?

Mr. G.O.Getter drew a sort of pitying sigh, walked over to the filing case and took out a receipted bill. He then asked Mr. P.E.Ewee what his bid had been, "\$5," was the answer. Without a word, G.O.Getter handed him the receipted bill which was for exactly \$100. At the sight of this, the little fellow almost passed out and for some time he was too stunned to speak.

By rights, this should be the end of the story but the best part is yet to come. We will, however, let Mr. G.O.Getter tell it to you in his own language.

"The little 'dub' just sat there and looked at me dazed and uncomprehending. Finally, he reached for his hat and as he turned to go, he barked back at me, 'Well, it must be politics.'"

This demonstrates clearly what is wrong with "dub" Servicemen who do not know psychology and who can never understand why the successful man succeeds. Incidentally, Mr. G.O.Getter still hadn't finished the story, because he confided in me that when he got the check for \$100, it was given to him most reluctantly because the person for whom the repairs were made has no use for the Union to which Mr. G.O.Getter belongs, so rather than having obtained the business through easy politics, he had to actually fight a hostile customer to get the business!

Incidentally, Mr. G.O.Getter did not always make money nor did he make it too easily. During the depression a few years ago, things became so bad in the servicing business that he even had to rig up electric bells to eke out a meagre living. One day he had an inspiration. He printed up a few calling cards with the legend, "Expert X-Ray Servicing." Now, Mr. G.O.Getter did not have a great deal of experience with X-ray machines but, being a radio man, he knew that they probably would be simpler than complex radio sets or public address systems. He soon had a telephone call from one of the local hospitals. He found upon arriving that what was wrong was a defective cord. The "dub" Serviceman probably would have charged 50c for the job. Mr. G.O.Getter charged \$3 and got it without a murmur of protest because he had looked into the X-ray servicing business and found that the big manufacturers of these machines charged exactly that price for cord replacements. He had read through all the literature of the manufacturers and knew what the price scale was. In no time he was doing the repair work for practically every hospital within the county. He still does it today—not personally, of course—but he has a man broken into the work who now does it for him.

Opportunities? Yes, there are plenty of them in this country and good money is to be made even today by Servicemen. If they don't, it usually is their own fault.

# •THE RADIO MONTH IN REVIEW•

The "radio news" paper for busy radio men. An illustrated digest of the important happenings of the month in every branch of the radio field.

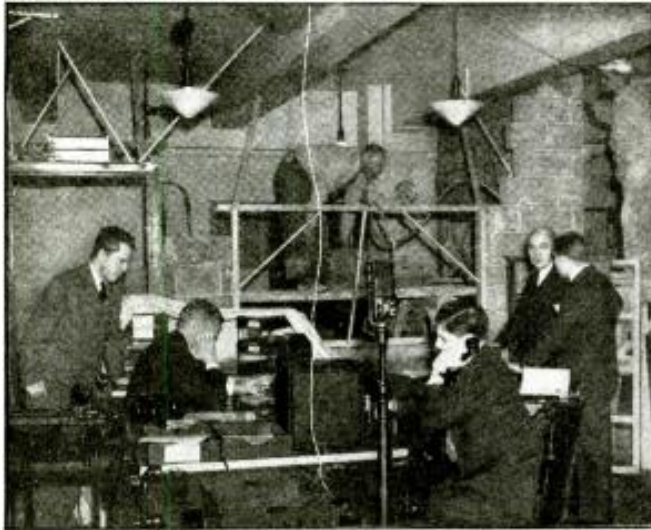

**"GOLDFISH BOWL"  
NEWS STUDIOS**  
◀ War and near-war conditions throughout the world, last month, speeded completion of N.B.C.'s new Special Events and News Studios here shown under construction. Glass-enclosed, the new speaker-type studios—built in the News Room, 4th floor, RCA Building, N. Y. C.—offer commentators no more privacy than is ordinarily accorded a goldfish. Feeding news bulletins through a slot, from the adjacent teletype and shortwave monitoring rooms, makes it unnecessary to open a door.



Photo—Hartford Courant  
**HAM-TELEVISION CAMERA-TUBE**

Amateur radio has won the distinction of being mainly responsible for the introduction, last month, of a comparatively low-cost Iconoscope or television image pick-up tube. This makes it possible for the first time for experimenters and shortwave enthusiasts to set-up their own experimental television transmitting stations! Photo shows Mr. Lamb holding the new type 1847 camera tube (right), and looking at the associated lens system; below is smallest previously-available image tube.

## ABROAD

**R**ADIO plays an indispensable part in modern warfare as evidenced by the bits of news that censors are passing these days. Items noted last month indicate in various degrees that this is so.

*Paris.*—A U.P. report credits the *Official Journal* with publishing a decree authorizing employees of radio stations to arm for protection in the exercise of their duties.

*Berlin.*—Radio stations of Luxemburg and Brussels have become part of the German Broadcasting System, A.P. announced.

*London.*—British Broadcasting Corp. engineers with the Advanced Air Striking Force have set up a broadcast studio and station on the French battlefield. Discs made with an A.A.S.F. recording van permit dubbing into programs, from the front to London, recordings made at airdromes and billets. Programs are written, censored and broadcast all in the same building. This technique enabled a French-German encounter on the Maginot Line to be broadcast blow-by-blow. (In similar fashion Berlin subsequently broadcast the account of a German-Belgian fight for an Albert Canal bridgehead, newspapers stated.—*Editor*)

*India.*—From Simla comes a U.P. report that all public and commercial radio licenses have been canceled; and that listening to

broadcasts from (a) enemy countries, (b) countries occupied by Germany, or (c) countries allied with Germany, is forbidden.

This calls to mind a recent incident. It seems that the reprint, in the Radio Month in Review department of the Nov. 1939, issue of *Radio-Craft*, of an actual newspaper clipping entitled "Nazis Are Warned to Shun Foreign Radio," aroused the ire of Mr. Josip Sliskovic, of Vienna. Mr. Sliskovic wrote to say that "As a neutral foreigner, living since 18 years in Germany and being the chief engineer of one of the biggest Vienna radio firms", he felt it his duty to write us the truth. As he puts it, the German Government never published the item we quoted; and he and his German friends everywhere were enjoying unrestricted listening privileges on multi-band receivers.

A short time after Mr. Sliskovic's letter was received, the *New York Daily News* printed a special cable from wholly neutral Basle, Switzerland, from which we quote:

"Despite the severe penalties risked, more and more Germans are listening to foreign news broadcasts to find out what really is going on." One German said a favorite method to avoid detection was for listeners to lie flat on the floor with the radio set and himself covered with several quilts to deaden the sound; another German said that in his

\*Chief Engineer, Kapsch-Radio, Vienna VII/62. St. l. gasse 21.

village of about 1,000 persons, near Basle, one member of a household would be assigned to keep a sharp lookout. The latter idea, of having lookout posted, seems to be much the likelier of the two.

A young lady member—Zoe, by name—of the Sidney, New South Wales, police, has been the No. 1 goodwill publicity attraction at various police functions for more than a year. Photographs received by *Radio-Craft* last month from Constable 1st Class Adam Denholm, trainer of this German shepherd dog, now 3½ years old, show 2 of the more than 180 tricks this dog has been taught to perform in response to orders received on the portable radio set she carries! These include drawing water from a well and pouring it over an unconscious man (photo on facing page), arresting an armed criminal, putting on and removing her collar, discharging explosives or a revolver, and unfurling the Union Jack and then sitting up while the National Anthem is being played! How about training "seeing eye" blind-aid dogs to follow radio commands?



## ULTRA-SHORTWAVE HORNS!

Here's one Ripley may spot! Instead of following schoolbook rules, which demands some wire-antenna arrangement for transmission and reception, Mr. A. P. King of Bell Telephone Laboratories has demonstrated that efficient, highly-directional radiation of 15-centimeter (3,000-megacycle) waves may be obtained by using metal horns. As the dash-line in photo shows, one merely points the horn-antenna of one station at the other, for distances within (ordinarily) the limits of the horizon. The fidelity is flat to 1 db. over a bandwidth of 250 megacycles, it is said.

## SHORTWAVES

**T**HE 1847, as the newest in Iconoscope (image viewing) tubes announced last month is designated, was developed by RCA Radion in cooperation with Mr. James J. Lamb, A.R.R.L. Research Engineer (see photo above). R. M. in R. suggests that radio Servicemen might try their hand at making up a sight-and-sound 2-Way Inter-Office Television Communication System, by combining, in duplicate, a standard television receiver or adapter with a simple transmitter incorporating the low-cost 1847. Use ordinary photographic floodlights for illuminating the subjects. The 1847 requires only 600 anode-volts, has better than 120-line definition, and has a mosaic under 2 ins. in dia. Electrostatic deflection is used.





TELEVISION HOPS 234 MILES TO SEA TO BE SEEN

Photos received last month show conditions aboard the *S. S. President Roosevelt*, en route from Bermuda, when the recent record of television signal reception aboard the ship, 234 miles at sea, was made. Above, ship passengers watch images received from the Empire State Building in New York; and, in second photo, as picked-up by a mobile unit on deck. Thus this trip between New York and Bermuda instituted the first "television voyage." Programs originating on the ship were piped by coaxial cables to receivers in the ship's

various public rooms. It is estimated that when the DX television record was made the boat was about 7 miles below the horizon with respect to the top of the Empire State Building. First explanation suggested by RCA for this unorthodox long-distance range was refraction of the ultra-shortwaves from a point where a cold layer of air formed a junction with a high warm layer of air. A second was that the ultra-S.W. signals were reflected from an ionized layer of the atmosphere.

Memorial Day traffic in New York City was unscathed by Police dept. monoplanes, 2-way-radio equipped. Instructions from the air to headquarters immediately were relayed to radio-equipped traffic cars. . . .

Professor Gordon Ferrie Hull, former chief of the ballistic division of the U. S. Army Ordnance Dept. and now a professor of physics at Dartmouth College, last month pointed out that ultra-short wavelengths such as may be generated by the W.F. "doorknob" tube (illustrated and described in the May, 1939, issue of *Radio-Craft*, pg. 658), have extremely important applications in war time. For example, ultra-S.W. beam radio communication between ships, or ships and shore, would be almost 100% free from interception (or perhaps even from jamming—especially with frequency-modulated transmissions?—Editor). The advantages of transmitting in a searchlight-like beam are also applicable to war fronts on land, Prof. Hull points out. . . .

Signals from N.B.C.'s shortwave station W3XAM last month played cops-and-robbers with the police radio system of the

Oranges (N. J.). Kiddie programs for a half-hour tangled with police headquarters reports to roving radio police cars.

F.C. Commissioner Fly last month handed a bouquet to the Susquehanna Emergency Network for its fine work in past emergencies. The tribute was paid to the S.E.N., a group of Susquehanna Valley and eastern seaboard radio amateurs affiliated with the A.R.R.L., by Mr. Fly during a C.B.S. program dramatizing the amateur network's successes, in cooperation with the American Red Cross, when rivers inundated large areas, snowstorms isolated communities, epidemics threatened large rural areas, and rare medial cures were needed to save dying persons. . . .

Hobbyists at a Bell Telephone System hobby show in Denver included many radio "hamateurs" (to quote The New Jersey Bell) who set up 2 complete 2-way short-wave systems, one for phone and one for code.

## F. M.

**F**REQUENCY Modulation seems to have earned for itself an almost permanent niche in this department of *Radio-Craft*. All news of the month of course pales into insignificance alongside the fact that the Federal Communications Commission took a deep breath and then announced the allocation of the full 42 to 50 mc. range to F.M. This necessitated kicking-out a television channel but the decision provides 40 F.M. channels, each 200 kc. wide; 35 are for commercial stations and 5 for "non-commercial educational" stations.

Newest score for frequency modulation reads 130 applications for transmitters pending at Washington. Immediate action is expected.

The new F.M. range clipped-out the No. 1 television band (44 to 50 mc.) which, after Jan. 1, 1941, will cover the former No. 2 band assignment (50 to 56 mc.); the old No. 2 band will be given a new yard in which to play (60 to 66 mc.); 16 other channels on still higher frequencies continue to be assigned to television. Now Mr. Serviceman can soon go to town on re-aligning the approx. 3,000 television sets in the New York area.

## SOUND

**C**OMMITMENTS keep "The Voice of Hollywood" from coming East for the broadcast series but recordings made in Hollywood, and mailed to WOR, solve the problem 3 times a week. . . . Mobile sound recording equipment sent to the San Simeon, Cal., home of veteran American publisher William Randolph Hearst; later, an air program, over station WMCA in New York, incorporated an extensive "interview" with Mr. Hearst. The "interview" was a transcription made from the pick-ups by the mobile unit and airmailed to WMCA.

Chime tones generated by 5 radio tubes now clarify the quarter-hours from a location, in a clock, at 7th Ave. and 47th St., New York City. A master clock in the N.B.C. studios regulates the timing.

Most unique recording of 1940, to date, is the "Flight of the Flagship," reports the *N. Y. Mirror*. The discing, by General Records, includes sounds heard on a transcontinental air flight: greetings of the stewardess, motor warm-up sounds, the dash-dot, dot-dash buzzes of the radio beams, etc.



"HER MASTER'S VOICE"—BY RADIO!  
(Cover Feature)

Miss Zoe, German shepherd dog on the staff of the Sidney, New South Wales police, has been taught to do many tricks via remote control. The photo shows this wonder dog receiving instructions—from the loudspeaker of the portable radio set strapped to her back—to fill a pail with water and to pour the water over an unconscious person! This is just one of the more than 180 tricks in her amazing repertoire. (Story on facing page.)



COUNT GEORG VON ARCO—1869-1940

The man mainly responsible for the formation of the German Telefunken Radio Co., Count Georg von Arco, died last month in Berlin at the age of 71. Often referred to as a born scientist and said to be a pacifist at heart, he resigned from military service in the Prussian army to devote all of his energies to the development of his ideas for radio equipment. New tuning systems, for instance, were invented by Count von Arco when crystal detectors were yet being developed.



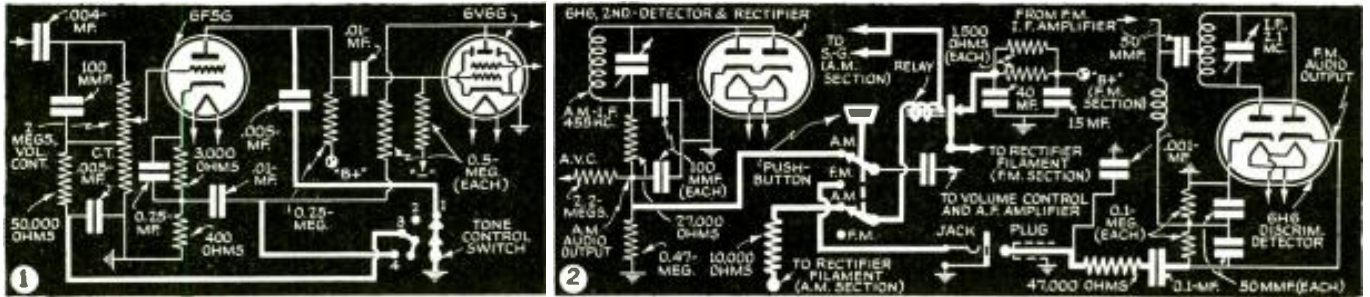

# NEW CIRCUITS IN MODERN RADIO RECEIVERS

*In this series, a well-known technician analyzes each new improvement in radio receiver circuits. A veritable compendium of modern radio engineering developments.*

F. L. SPRAYBERRY

No. 35



(FIG. 1) 4-POSITION TONE CONTROL HAS UNUSUAL CIRCUIT

FADA MODELS 64APC, A66PC, 74APC AND A76PC.—A single switch grounds (a) a regular tone control condenser, (b) an inverse feedback circuit, and (c) a bass compensator circuit, in proper combination to achieve the tonal quality desired.

We may see, as in Fig. 1, that when contact 1 is grounded by the switch, the high frequencies in the audio circuit are progressively attenuated. The bass compensator and inverse feedback circuits function normally in this position. In position 2, all tone control circuits are open. In position 3, the bass compensator circuit is made inoperative by shorting out the 0.005-mf. condenser in the bass compensator circuit. In position 4, both the bass compensator and the inverse feedback circuits are shorted out.

The effect on the tone of progressing from points 1 to 4 is to obtain deep, mellow, normal and brilliant tones in succession.

(FIG. 2) PUSHBUTTON AMPLITUDE-FREQUENCY MODULATION CHANGEOVER

STROMBERG-CARLSON No. 435.—With a double pole-double throw switch operated by a pushbutton and a relay, reception may be switched from amplitude modulation to

frequency modulation in this receiver in 2 units; each with a separate power supply.

In the amplitude modulation (A.M.) position, as shown in Fig. 2, the regular audio output is derived from the usual diode rectifier, while the 1st-detector and I.F. screen-grid voltages for the A.M. receiver section are supplied through a relay solenoid. In carrying this screen-grid current, the relay opens the entire high-voltage supply for the frequency-modulation sections of the receiver.

(FIG. 3) FILTER INPUT CONDENSER PROTECTION

STEWART-WARNER MODELS 03-5R, 07-5R AND 03-5S.—While it has now become general practice to make use of a resistance in the plate circuit of a half-wave rectifier for A.C.-D.C. supply, this has not been found adequate to protect the input filter condenser from voltage surges.

The plate resistance has taken the form of a pilot and a section of the rectifier filament as in Fig. 3, but did not have all the anticipated advantages with respect to the input filter condenser. Now, a small resistance, 33 ohms in this case, has been placed between the cathode of the rectifier and the filter input to limit the peak voltage on the filter input condenser. As a

result, less failure of input condensers has been achieved.

(FIG. 4) CIRCUIT MUTING ACHIEVED BY OPENING CATHODE CIRCUIT

CROSLLEY MODEL 719.—By means of push-button control, a grounded switch lever is released from the output cathode circuit, and connected to the solenoid of the magnetic tuning coil.

"Magnatune" for operation of the tuning mechanism. When the tuning operation is completed, the grounded switch arm is again returned to the output cathode circuit and reception is resumed. The circuit is shown in Fig. 4.

(FIG. 5) CRYSTAL MICROPHONE AND PREAMPLIFIER USED IN RECORDING

WILCOX-GAY MODEL A-70.—Being provided with complete recording equipment, this receiver makes use of a crystal microphone and pentode preamplifier.

The preamplifier is a 6J7. The signal level entering the 1st audio grid (6Q7) may be comparable with that from the radio tuner and crystal pickup also entering at this point.

The circuit of the microphone and its preamplifier is shown in Fig. 5. It is one of the 3 inputs selected for the audio channel.

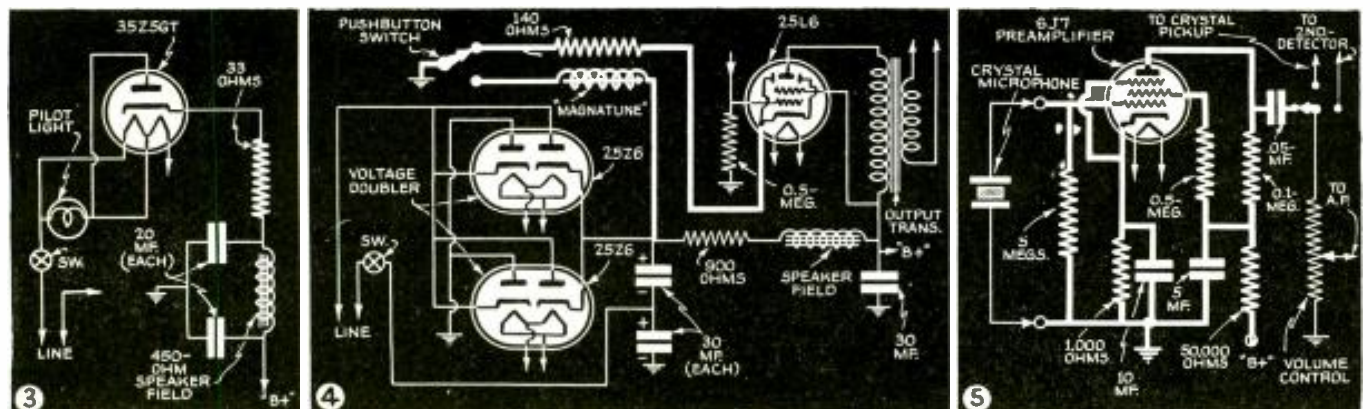



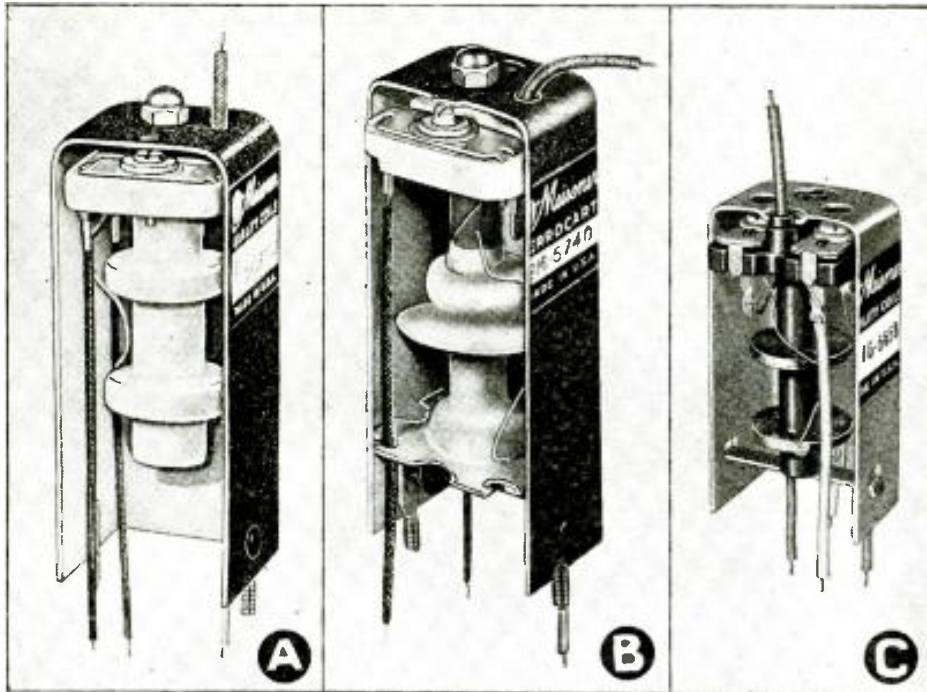

The June issue of Radio-Craft contained the first article in this valuable series on coils; the title: "Servicing R.F. Coils." The July issue contained the article "Replacing I.F. Coil Windings." In this 3rd, next to concluding article, the author gives Servicemen and experimenters information they have long been wanting on the considerations involved in properly replacing manufactured I.F. coils.

Fig. 1. A—Standard Meissner air-core I.F. transformer; B—iron-core I.F. (increased selectivity); C—new "plastic" I.F. transformer.

# REPLACING I. F. TRANSFORMERS

L. V. SORENSEN

IN the article entitled "Replacing I.F. Coil Windings," published in last month's issue of *Radio-Craft*, it was pointed out that when an I.F. transformer fails there are 2 possible courses to pursue in making the repair: (1) either replace only the defective winding; or, (2) replace the entire I.F. transformer. The conditions that dictate replacement of the coil only were discussed in that article and detailed directions were given for making the repair. This next article concerns repair by replacing the *entire* transformer.

## ECONOMICS OF REPLACEMENT

The Serviceman, like the doctor, has essentially only one commodity to sell—his knowledge of the operation of a given kind of device, in this case radio sets, and his ability to correct their malfunctioning. In order to sell the greatest quantity of this commodity, the Serviceman should confine his efforts to diagnosing trouble and to checking repaired sets, leaving to an assistant the actual work of repairing.

The installation of a completely engineered and factory-made replacement I.F. transformer is a task easily done by the least experienced assistant, requiring only checking and aligning by the Serviceman; and, in rare cases, the elimination of oscillation when the factory-made product results in enough greater gain over the original transformer to cause oscillation. On the other hand, the installation and adjustment of replacement I.F. windings require the knowledge, experience and judgment of a qualified Serviceman, and is a task not properly delegated to an assistant.

*Replacement Transformers vs. Replacement Transformer Windings.*—As long as factory-made replacement I.F. transformers of good quality are available at attractive prices the sound-thinking Serviceman will realize that he can not afford *not* to use them, falling back on Replacement I.F. Windings only on those occasions where no

satisfactory complete Replacement Transformer is available. There is only one condition when this is not true—when there are a number of sets of the same model to be repaired, in which case the spacing of replacement windings may be worked out on one set and then applied to all of the remaining sets. Practically the only occasion for such a condition to occur is when a Serviceman is connected with a large dealer or jobber handling a single line of receivers.

## SELECTION OF REPLACEMENT I.F. TRANSFORMERS

By far the greater number of radio receivers employ only 1 I.F. amplifier tube which means that both the input and output I.F. transformers must have high gain if the set is to be adequately sensitive, unless there is a high-gain stage of R.F. amplification ahead of the converter (which is comparatively rare). Even in the case of such a set the gain produced by a pair of high-gain I.F. transformers is seldom objectionable. In the few cases where a set may be too sensitive because of the use of a high-gain replacement transformer the sensitivity can always be reduced by a shift in either cathode bias or screen voltage. It can therefore always be assumed that the *correct replacement I.F. transformer for a set with 1 I.F. stage should be of the high-gain type.* Replacement I.F. transformers of various types are shown in Fig. 1; these have 1 side of the shield can cut away to clearly show the interior construction.

The air-coil (Fig. 1A) and iron-core (Fig. 1B) I.F. transformers have coils protected by a heavy coating of white wax. Shields are 1½ ins. square and 3½ ins. long.

The "plastic" I.F. transformer (Fig. 1C) is featured by a 1-piece molded low-loss trimmer-base and coil form, held in place in the shield can by a novel flat-spring mounting arrangement. Coils are protected by "Q-Max"; shield is only 1¼ ins. square and 2½ ins. long.

When radio sets have 2 I.F. amplifier

tubes and 3 I.F. transformers, in a circuit similar to Fig. 2A, the transformer windings employed produce comparatively low gain-per-stage, at least in the 1st and 2nd transformers. The last transformer driving the diode usually enables amplification approaching that of a conventional "Output" I.F. transformer for a set with only 1 I.F. tube.

Sets that employ 2 I.F. tubes but only 2 I.F. transformers instead of 3, as in Fig. 2B, usually employ a resistance-capacity coupling network between the 2 tubes in much the same fashion as a resistance-capacity coupled audio-frequency amplifier.

The only essential difference lies in the values of the resistors and the condenser, in the frequency of the signal (I.F.) and in the amplification produced, which is much lower than that produced by the conventional resistance-coupled audio stage. Such sets employ high-gain input and output I.F. transformers and should be considered in this discussion as belonging to the type of sets having only 1 I.F. stage. Returning again to the set with 3 I.F. transformers, it must be realized that at least 1, probably 2 and possibly all 3 transformers employed have low gain so that the overall amplification will not be too high. If one of these transformers is replaced with a high-gain transformer it is probable that the circuit will oscillate.

It is also probable that such a set has a super-abundance of I.F. gain and that consequently, if the replacement transformer happened to have somewhat lower gain than the original transformer, the set would still be amply sensitive for normal reception. Following this idea and considering that the 1st and 2nd I.F. transformers usually have low gain in sets with 3 I.F. transformers, the logical replacement for either the 1st or 2nd of these transformers is a Meissner "Interstage" transformer which was purposely designed to have low gain. The Serviceman, with his signal-generator and output meter, can quickly tell

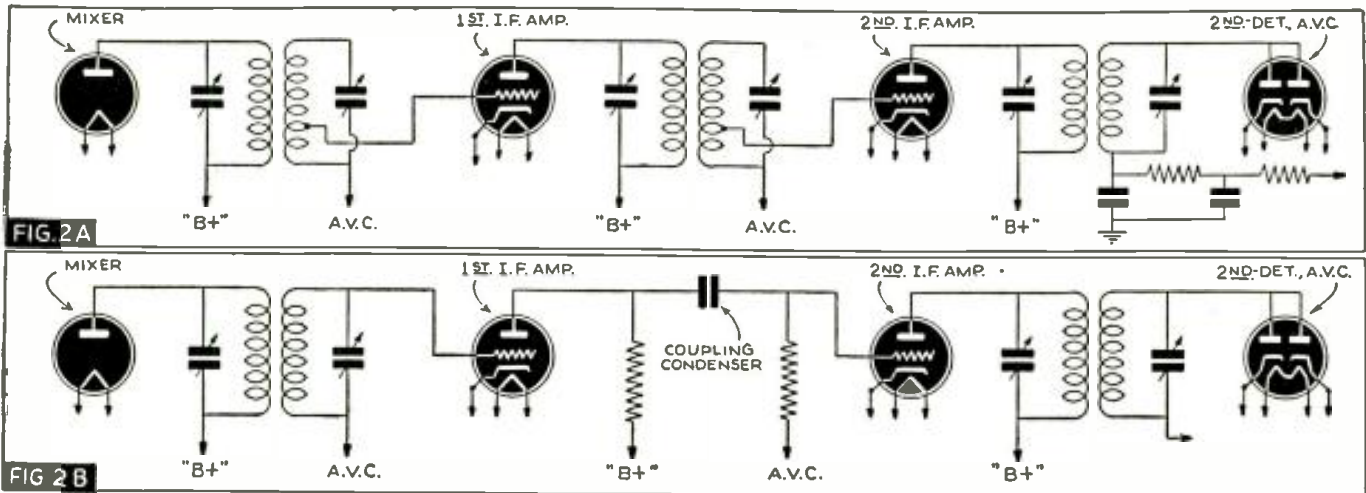

whether the use of such an "Interstage" replacement transformer (low-gain) has made the set too insensitive for satisfactory service. In those rare cases in which the sensitivity is too poor, it will be necessary to change the "Interstage" transformer for an "Input" transformer which has higher gain. If the practice of replacing either the 1st or 2nd I.F. transformer (of a set with 3 I.F. transformers) by an "Interstage" transformer is followed, the number of cases in which it may be necessary to change the "Interstage" for a higher-gain unit will be far fewer than the number of cases of oscillation or excessive regeneration that it would be necessary to correct if high-gain transformers were always installed first.

In the case of the 3rd I.F. transformer, feeding a diode detector in most instances, the gain may approach that of the conventional "Output" I.F. transformer. It is, accordingly, recommended that an (Meissner) "Output" I.F. transformer be the first choice as a replacement for this transformer.

**INSTALLATION OF REPLACEMENT I.F.T.**

The replacement transformer should be installed in the defective receiver in as neat a manner as possible because customers frequently judge the technical quality of repair work by the mechanical appearance of the finished repair.

In some instances it may be necessary to drill new holes in the chassis for mounting the replacement transformer. A few minutes spent to properly lay out the holes so that the transformer, when mounted, will be appropriately spaced with reference to adjacent parts and will have its sides parallel to or at right-angles to prominent sides or edges of adjacent objects is a good investment. When replacement transformers are put on a chassis at odd angles with respect to adjacent parts the customer is quite likely to undervalue the technical ability of the Serviceman in direct proportion to his apparent lack of care in making the installation of the new parts.

In case that the hole under the original transformer is too large to permit the replacement transformer to be mounted over it, a flat metal plate should first be installed and the replacement transformer mounted on it. In any case, the work should be done as neatly as possible.

The leads on the replacement transformer may have a different color code than the original transformer leads; consequently the original color code should not necessarily be followed. The popular I.F. replacement transformers have the following color code unless otherwise specified:

**INPUT & INTERSTAGE I.F. TRANSFORMER COLOR CODE**

- Red = "B+"
- Blue = Plate
- Green = Control-Grid
- Black = A.V.C.

**OUTPUT I.F. TRANSFORMER COLOR CODE**

- Red = "B+"
- Green = Diode
- Blue = Plate
- Black = Diode Load
- Yellow = Center-Tap (when used)

This code of connections must be followed if proper results are to be obtained.

The POSITION of the blue (plate) lead and the green (diode or control-grid) lead should be carefully chosen so as to be as far away from other grid or plate leads as possible. Usually the position of the original control-grid and plate leads is a reasonable guide to the best position for the leads of the replacement transformer, but in cases of oscillation trouble that occasionally develop when the replacement I.F. transformer has higher gain than the original transformer, the original lead positions may not necessarily be best, and a new position with greater separation between certain "hot" leads may have to be selected.

As a rule, the blue and green leads should be as short and direct as possible. The length and path of the red lead is seldom of any consequence on any (Meissner) I.F.

transformer. The length and path of the black lead is seldom of any consequence on input or interstage transformers but on output transformers should be short and direct to the diode load resistance and should be kept close to the chassis.

When the defective transformer is an output transformer with the diode filter and perhaps part or all of the diode load resistors and condensers assembled in the same can there arises the problem of what to do with these extra parts. If the set is large it is recommended that these extra resistors and condensers be assembled neatly on an insulated terminal strip as in Fig. 3 and that the strip then be installed under the chassis close to the replacement I.F. transformer. This is, of course, not the best practice technically which would be to put the parts back into the new transformer, but is a reasonable procedure in making a satisfactory repair with a minimum expenditure of time.

The arrangement of parts shown in the figure, is merely a suggestion, as the actual values and connections depend upon the original circuit. If the set is congested it is recommended that these extra parts be installed in the base of the replacement transformer either on parts removed from the old transformer or on any reasonable substitute that can be improvised by the Serviceman.

**SHIELDED LEADS**

The use of shielded leads should be avoided because close-fitting shielding disturbs the I.F. transformer characteristics in several ways. The 1st and most apparent effect of close-fitting shielding on the grid, diode, or plate leads is to add to the circuit capacity. This requires that the trimmer condenser in the transformer be operated at a correspondingly lower capacity.

If the shielded lead is long and the shielding is close fitting it is entirely possible that the amount of capacity added in the shielding may be more than the amount required to tune the transformer, in which case the trimmer will never "peak" but the output will only approach a maximum as the capacity is reduced. In a less exaggerated case, where the capacity added in the shielded lead is not enough to prevent the trimmer from "peaking," the "peak" may occur at a setting of the trimmer condenser that is too loose for stability when the transformer is subjected to vibration.

A convenient check for this fault is to hammer on the side of the transformer with the handle of a screwdriver after the transformer has been aligned. If the output changes materially due to hammering, the

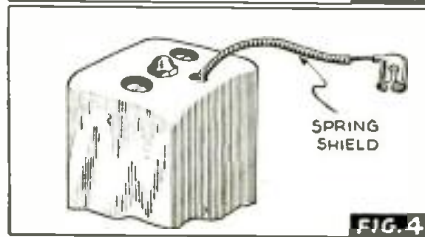
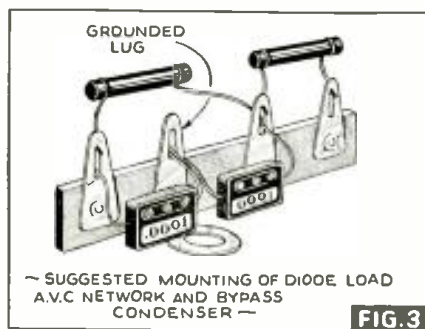



**Quick, now, what are the answers to the following questions?**

- (1) Under what conditions is it preferable to install a Replacement Transformer instead of a Replacement Transformer Winding?
- (2) How does a "plastic"-type I.F. transformer differ from air-core and iron-core types?
- (3) What instruments would you use to check for excessive gain caused by an interstage-type replacement I.F.T.?
- (4) What are the causes of, and remedies for, Single-Stage Oscillation?
- (5) What are the causes of, and remedies for, I.F. circuit oscillation off-resonance?

Give up? Then, read this article, which answers these questions — and many more—in detail.

trimmer is probably too loose, and the shielding should be reduced to permit the trimmers to be worked at a more stable part of their capacity curves.

The 2nd objection to shielding on grid, diode or plate leads is that the insulation on the hook-up leads CHANGES CAPACITY and POWER-FACTOR (losses) with changes in atmospheric humidity. These changes cause the sensitivity of the set to shift with the weather. These shifts in sensitivity can become very bad if excessive amounts of shielding are used.

The 3rd objection to close-fitting shielding is that the insulation on ordinary hook-up wire has relatively high R.F. losses, lowering the "Q" of any coil to which the shielded wire is connected.

In A.C.-D.C. sets of the Underwriters-approved types there is another objection to shielding on either the diode or diode-return leads when the shielding is connected to the chassis. In such sets the "B-" point in the set is isolated from the chassis and is bypassed to it by a condenser whose capacity does not exceed 0.25-mf. Because of the capacity of various parts of the set to chassis, and because the isolating condenser is of limited capacity the chassis is not at "B-" A.C. potential nor, for that matter, is it at the potential of any other point in the set.

Across the isolating condenser appear audio frequencies from the filament supply as well as components from the half-wave rectified current. When a shield on a diode or a diode-return lead is connected to chassis the hum voltages appearing across the isolating condenser are impressed by the shield onto the high-impedance diode circuit, causing an audio hum voltage to appear across the volume control which, of course, is converted by the speaker into an audible hum. If the shielding is connected to the "B-" point in the chassis, this hum will not be present, but it will then be necessary to insulate the outside of the shielding so that it cannot ever come in contact with the coil shield, the chassis, or any other metallic object attached thereto. Unless this is done some one may accidentally receive an unpleasant or even dangerous shock upon touching the chassis and any grounded object simultaneously. Where flexible-spring shielding such as shown in Fig. 4, has been used on one of the leads on the original transformer, it is usually good practice to use the same shielding on the corresponding lead of the replacement transformer. This is permissible because the shielding is not tight on the wire and because the length of shielding is seldom more

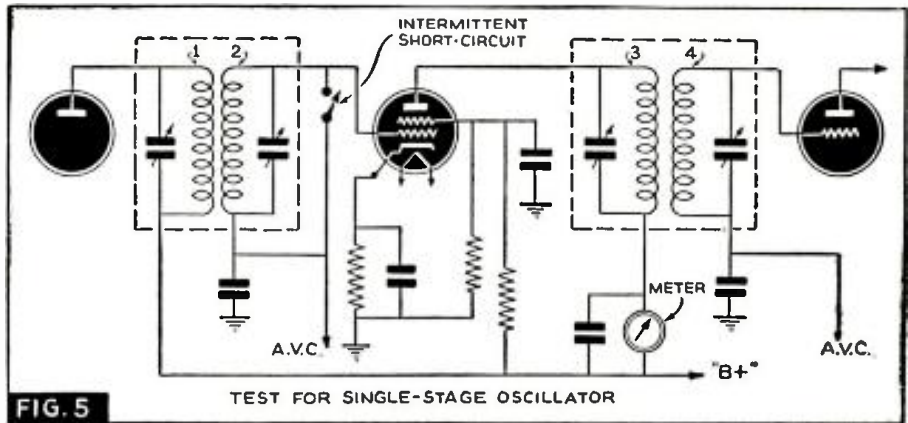

than 2 or 3 inches. It is, in other words, a low-capacity shield.

On experimental or custom-built sets that have not enjoyed competent engineering, long grid or plate leads have sometimes been employed without the builder being aware of the troubles that may result. When shielding is added to such leads, to eliminate troublesome coupling, it should be of large diameter such as is used on the "lead-ins" of auto-radio sets.

**ALIGNMENT**

After the replacement transformer is installed it should be aligned. It is true that all Meissner replacement I.F. transformers have been aligned in the factory and tested for gain and selectivity before shipment, but installing the transformers in receivers in which the circuit wiring has a different capacity than that which existed in the test set, coupled with the fact that the intermediate frequency of the receivers may be some kilocycles different from the frequency to which the transformers were adjusted in the factory, requires that the transformers be re-aligned after installation. The methods of aligning are so well known that the details of that simple process are omitted.

**OSCILLATION AND FEEDBACK**

There will be a few sets in which the replacement transformers will result in enough more amplification than the original transformer that oscillation will result. The following discussion of the subject of oscillation gives an account of the most important methods by which feedback occurs and shows how oscillation caused by the feedback can be cured.

Feedback can be divided roughly into 2 classes: (1) Single-stage, and (2) Overall. Single-stage feedback is literally what the name signifies, whereas under the heading of "Overall Feedback" are considered all types of feedback involving more than 1 tube.

**SINGLE-STAGE OSCILLATION**

Single-stage oscillation in amplifiers is usually the least understood type of regeneration trouble. It has frequently baffled Servicemen and experimenters. It is peculiar in that no amount of filtering applied to plate supply, screen, cathode or A.V.C. circuit, nor any amount of shielding seems to make any improvement. This form of trouble is seldom encountered in a set made by a reputable manufacturer if the set is in its original condition and has the original sets of tubes in the original sockets. Experimental sets, custom-built sets and sets that have had new I.F. transformers installed on them are far more likely to exhibit single-stage oscillation.

The enthusiastic amateurs or experimenters may select I.F. transformers of the highest-possible gain characteristics for

their sets and then wonder why they have so much difficulty making a single I.F. stage behave; and why they have to use such abnormally high biases on their I.F. amplifier tubes before stability is attained. The fact of the matter is that the grid-to-plate capacity of the I.F. amplifier, although it is only 0.01-mmf. or less, is the limiting factor in the amount of gain that can be obtained from a tube before oscillation results.

In order to obtain high gain from an amplifier it is necessary that the coupling impedances be very high. To this end, I.F. transformers have been built with higher and higher inductance and with better and better (higher-"Q") coils until, when used in an amplifier, the amplifier oscillates. If this oscillation persists even after completely shielding the stage and isolating the screen-grid, "B+", cathode and A.V.C., the limit of amplification possible with that tube and circuit has been reached. Only by neutralizing the grid-to-plate capacity of the tube can circuits of higher gain be used. What actually occurs is that a part of the I.F. voltage appearing in the plate circuit of the tube gets back through the grid-plate capacity of the tube and impresses itself on the grid circuit. If the amount of this feedback voltage is large enough and the impedance of the grid circuit is high enough, sustained oscillation will result in much the same fashion as the well-known "Tuned-Grid—Tuned-Plate" transmitting circuit performs. Technically speaking, it is also necessary that the phase relations be correct, but these can so easily be changed by slight adjustments of the trimmer that it is a foregone conclusion that the proper adjustment for oscillation will be obtained when the impedances are high. The remedies for single-stage oscillation are:

- (1) Use a close-fitting tube shield on the offending tube.
- (2) Use a tube with lower grid-plate capacity.
- (3) Use a tube with lower mutual conductance.
- (4) Raise the bias on the present tube until oscillation stops.
- (5) Use circuits of lower impedance.
- (6) Neutralize the grid-plate capacity.

If the positions of the grid and plate leads of the I.F. transformer are already located one above the chassis and the other below and if the tube has around it a close-fitting shield that is grounded to the chassis, there is nothing further that can be done from this standpoint to improve the situation. If these conditions are not all fulfilled some improvement may be made by adding the tube shield or placing leads for lower coupling.

Concerning lower grid-plate capacity, it can be said that normally this parameter of tubes is quite constant although occasionally there are a few tubes with capac-

# ... "B"-line to profit!

Stock the "B" battery that revolutionized the portable radio industry—"Eveready" "MINI-MAX" 45 volt "B" battery—its light weight means heavy profits for you!



"Eveready" "MINI-MAX" means less weight ...less bulk... portable radios that are really portable without sacrifice in service life. It gives twice the service life of any other "B" battery of equal size!

Over 30 manufacturers have designed portable receivers around the "Eveready" "MINI-MAX" No. 482. Your customers will demand this mighty midget in the busy season ahead. Get your order in today!

**NATIONAL CARBON COMPANY, INC.**

General Offices: New York, N. Y.  
Branches: Chicago and San Francisco  
Unit of Union Carbide and Carbon Corporation



The words "Eveready" and "Mini-Max" are registered trade-marks identifying products of National Carbon Company, Inc.



**HIGH-CAPACITY  
LOW-VOLTAGE**

- DANDEES—those popular mid-gate electrolytics with the very latest refinements—are now available in high-capacity low-voltage units for special by-pass and filtering functions. 1000 to 3000 mfd. 6, 12 and 15 v. D.C.W. Units are supplied with mounting straps except for a larger can size unit which has standard mounting ring. • Ask jobber to show you these units. • Ask for latest catalog— or write us direct.



GET this handy Tube Complement Book. . . 165 pages of useful tube information you'll use every day. Packed with up-to-the-minute data including the tube complements and i-f peaks of all the recently announced sets. If you already have the complement book and want only the new 1940-41 supplement send 10c or if you want both—with the supplement bound in—send 25c to Hygrade Sylvania Corporation, Dept. RC80, Emporium, Pa.

ities up to or even exceeding 10 times their normal value. It is always recommended that several tubes be tried in an oscillating I.F. amplifier (realigning each time) before doing much work to determine the cause of oscillation or attempting to correct it.

It can also be said that some G (glass) or GT (bantam glass) equivalents of metal tubes have appreciably more grid-plate capacity than the corresponding metal tubes. Therefore, if the tube giving trouble is a G or GT tube and the metal equivalent is handy it is wise to try the metal tube, being sure however to realign the circuits.

Concerning the use of a tube with lower mutual conductance, one might say that such a remedy is academic and is included only for sake of completeness. It is far more practical and logical to raise the bias on the offending tube until its mutual conductance is reduced far enough to establish stability:

The use of lower-impedance circuits is a very wise procedure for eliminating single-stage oscillation and is the method employed by qualified radio engineers when designing receivers. When high-impedance circuits are used and the I.F. amplifier tube is biased-up to attain stability, the A.V.C. characteristic of the receiver suffers, the degree of control becoming less as the minimum fixed bias is increased. In (Meissner) replacement I.F. transformers the circuit impedances were carefully chosen to prevent single-stage oscillation in practically all cases. There will still be found, however, a few sets in which the remaining good transformer has a high enough impedance to cause the stage to oscillate when a (Meissner) replacement transformer is installed. Such sets call for increased cathode bias to restore stability. The use of neutralized circuits in combination with screen-grid tubes is academically interesting and has been of practical interest in a few special cases but normally such circuits are no longer used to any extent.

Since a complete understanding of single-stage oscillation involves a knowledge of circuit impedances, at least qualitatively, the following explanation of the changes in circuit impedances is given as a background for explaining a peculiar phenom-

enon that some Servicemen may have noticed which is that some I.F. amplifiers oscillate when some of the trimmers are out of adjustment and that as alignment proceeds the oscillation stops.

**Anti-Resonance Oscillation.** — When an inductance is shunted by a condenser a "resonant circuit" is formed whose impedance is very high at the frequency to which the circuit is tuned but the impedance drops off very rapidly above or below this frequency, soon reaching a low value. The impedance at resonance is approximately equal to the product of frequency times  $2\pi$ , of inductance, and of the "Q" of the circuit.

When 2 similar circuits are separated far enough so that they have no effect upon each other (are not coupled) and they are both tuned to the same frequency, they each have a definite high impedance, but if these circuits are brought progressively closer together (coupled) until "critical coupling" is reached, the magnitude of the impedance of each circuit will drop to approximately  $\frac{1}{2}$  of the original impedance when isolated from each other.

When the position of the coils of 2 tuned circuits is fixed, as in the conventional I.F. transformer, and the trimmers are adjusted so that the circuits are tuned to vastly different frequencies (are electrically far apart), the impedance of each circuit is high at the frequency to which it is tuned. Now if one of these circuits is tuned to the intermediate frequency it will have its highest impedance at that frequency when the other circuit is tuned to a frequency far removed from it, but as the frequency of the 2nd circuit is brought progressively closer to the intermediate frequency the high impedance of the original tuned circuit begins to drop until when both circuits are resonant to the same frequency, the impedance of the original tuned circuit reaches its lowest value, approaching  $\frac{1}{2}$  of the original value if the coils are "critically coupled." When an I.F. amplifier such as is shown in Fig. 5, is stable with all circuits in resonance and oscillates when the 1st and 4th circuits are detuned in opposite directions, the oscillation is caused by the impedance of the 2nd and 3rd circuits reaching or exceeding the critical value as the 1st and 4th circuits are detuned.

All competent engineers designing radio sets test their designs for this type of trouble so that they will be sure that even though the I.F. trimmers or coils may drift a little from exact alignment, the circuit impedances will not rise high enough to cause single-stage oscillation. Occasionally, however, when sets have been pushed to obtain the maximum sensitivity from average tubes, exceptionally high-gain tubes may cause oscillation with surprisingly little detuning. The usual remedy is to use a tube not quite so good or to raise the bias slightly.

The most certain check for single-stage oscillation is to connect to the grid of the suspected tube the I.F. probe of a Meissner Analyst or similar "Signal Tracing" service equipment and to watch for indications of the presence of a strong I.F. signal when the 1st and 4th circuits are detuned in opposite directions while the 2nd and 3rd circuits are left in alignment. If no Analyst or equivalent is available, a milliammeter connected as shown in Fig. 5, bypassed by a 0.1-mf. condenser, can be used to check for single-stage oscillation in the following manner:

Detune the 1st and 4th circuits in opposite directions, then watch the milliammeter while an intermittent short-circuit is applied to the control-grid of the tube, meanwhile slowly shifting the grid trimmer



slightly above and below resonance. If the plate current changes when the short-circuit is applied and removed, the circuit is changing from the oscillating to the stable condition, or vice versa.

**OVER-ALL REGENERATION**

Over-all oscillation is a familiar complaint on multi-stage T.R.F. receivers, even of good design, and on I.F. amplifiers of high gain. On experimental receivers in the process of development it may be produced by any one of a number of causes. Only by experiment can the offending source of coupling be discovered and removed. It may be of 2 general types, high-impedance or low-impedance; or might be considered voltage feedback and current feedback although all feedback phenomena in radio receivers are, strictly speaking, voltage feedback phenomena.

Coupling between antenna and control-grid or plate leads, and couplings between control-grid leads or plate leads, etc., all of which impress relatively high voltages on the very small capacities existing between the points just mentioned, are classed as high-impedance feedbacks. Appropriate partition-type shielding quickly stops this type of feedback. Under the heading of low-impedance feedbacks are placed all oscillation troubles resulting from the use of common cathode, screen-grid or plate bypass condensers, common leads in high-frequency circuits, couplings resulting from the common shaft of a gang condenser, etc. Eliminating oscillation from these sources requires a study of the receiver and many experiments, isolating the various circuits that are suspected of causing the feedback, until finally the real offender is discovered.

Sometimes feedbacks are degenerative instead of regenerative and the disconcerting fact may be discovered in some cases that isolation of certain circuits increases rather than decreases oscillation troubles.

On manufactured receivers made by a reputable company which attempts to keep uniform quality, over-all oscillation after some time in service can usually be traced to some circuit element that changes characteristics with age. For example, if no paper condenser is used across the electrolytic filter condenser to insure a permanent low-impedance R.F. path to ground, over-all I.F. oscillation can occur when the R.F. resistance of the electrolytic filter condenser increases with age.

In T.R.F. receivers, frequently high-resistance contacts between the gang-condenser shaft and the wipers causes over-all oscillation which can be eliminated by a thorough cleaning of the contacting surfaces. Common bypass condensers also should be suspected as the cause of feedback. When they are, they are usually found very easily by connecting a known good condenser across each bypass condenser successively until the defective unit is found.

**REGENERATION OF A.C.-D.C. SETS**

In A.C.-D.C. sets of the Underwriters-approved types, regeneration is usually a serious design problem because the chassis is not solidly connected to the "B-" point in the receiver but is merely bypassed to that point by a capacity not exceeding 0.25-mf. This isolation of the chassis from the "B-" point, which is usually one side of the power line, is done to eliminate the hazard attached to a set that has its chassis connected solidly to the power line. For the same reason the capacity allowed between the chassis and the minus "B" is limited to 0.25-mf.

Since every alternating or pulsating voltage in the set causes some small current to

(Continued on following page)

*Highly Sensitive*  
**VOLT-OHM-MILLIAMMETER**  
**25,000 OHMS PER VOLT**

**TRIPLET**  
**MODEL 1600-E**

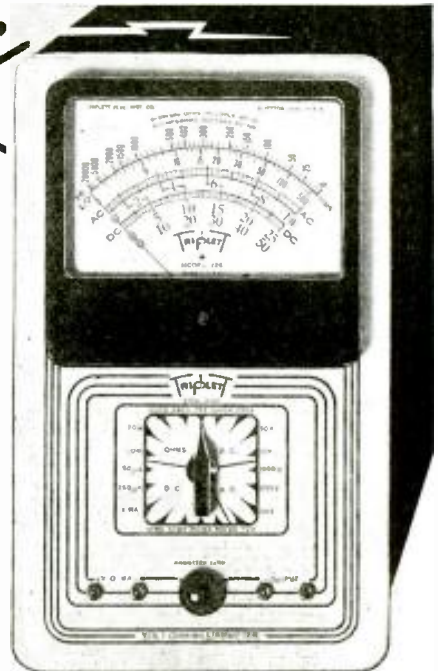

MODEL 1600-E

D.C. scales of the instrument read: Voltage 0-10-50-250-1000 (25,000 ohms per volt); Current 0-50-250 microamperes; 0-1-10-50-250-500 milliamperes; Resistance, low ohms, bakcup circuit, 1/2 to 500; high ohms, 20,000, 200,000 ohms and 2 megohms at 1 1/2 volts. Additional resistance measurements available by using 1 1/2 volts of battery for each two megohms. AC Voltage 0-10-50-250-1000 at 1000 ohms per volt. A plug-in copper-oxide rectifier, easily replaced in case of overload, is used to obtain A.C. readings. Model 1600-E, less Case, for mounting in panel . . .

Model 1600-E in case for portable use . . . Dealer Net Price . . . \$25.50

Only  
**\$21.00**

DEALER NET PRICE



WRITE FOR CATALOG  
 Section 168 Harmon Drive

**3-WAY VOLT-OHM-MILLIAMMETER**

A REAL non-obsolete Tube Tester combined with a Volt-Ohm-Milliammeter and Free Point Tester. Volt-Ohm-Milliammeter AC and DC. Volts 0-10-50-250-500-1000 at 1000 ohms per volt. Free Point Tester with sockets for all tubes including 6X4, 6X5, 6X6, 6X7, 6X8, 6X9, 6X10, 6X11, 6X12, 6X13, 6X14, 6X15, 6X16, 6X17, 6X18, 6X19, 6X20, 6X21, 6X22, 6X23, 6X24, 6X25, 6X26, 6X27, 6X28, 6X29, 6X30, 6X31, 6X32, 6X33, 6X34, 6X35, 6X36, 6X37, 6X38, 6X39, 6X40, 6X41, 6X42, 6X43, 6X44, 6X45, 6X46, 6X47, 6X48, 6X49, 6X50, 6X51, 6X52, 6X53, 6X54, 6X55, 6X56, 6X57, 6X58, 6X59, 6X60, 6X61, 6X62, 6X63, 6X64, 6X65, 6X66, 6X67, 6X68, 6X69, 6X70, 6X71, 6X72, 6X73, 6X74, 6X75, 6X76, 6X77, 6X78, 6X79, 6X80, 6X81, 6X82, 6X83, 6X84, 6X85, 6X86, 6X87, 6X88, 6X89, 6X90, 6X91, 6X92, 6X93, 6X94, 6X95, 6X96, 6X97, 6X98, 6X99, 6X100.

**MODEL 1183**  
**\$49.84**  
 Dealer Net Price

**THE TRIPLETT ELECTRICAL INSTRUMENT COMPANY**  
 Bluffton, Ohio

**GET A REAL ELECTRIC SHAVER ABSOLUTELY FREE!**  
 Complete details as to how it is possible to get a Real Electric Shaver FREE, appear on Page 122 of this issue. TURN TO IT NOW!

**BROADCAST NEWS ITEMS**

Says Dr. Raymond B. Fosdick (pres., Rockefeller Foundation), those who listen most to radio programs find the least interest in their reading. Hence, "radio listening" predominates among those who never reached high school, and decreases as the level of literacy rises toward college graduates. . . . Yesterday it was little more than a pile of rocks sticking out of the water at high tide, but soon it probably will be filled-in and made the site of WABC's broadcast transmitter (now located in Wayne Twp., N. J.), for Little Pea Island in Long Island Sound recently was purchased by Columbia Broadcasting System.

**Simplest WAY TO REPLACE BALLASTS**

4 STANDARD TYPES of Amperite Regulators replace over 200 types of AC-DC Ballast Tubes now in use. . . . Has patented automatic starting resistor.  
 List \$1.00  
 WRITE FOR REPLACEMENT CHART "S"  
 Amperite Co. 561 Broadway, N. Y. C.

**AMPERITE**

## •SERVICING•

(Continued from preceding page)

flow through the capacity of the parts to the chassis, thence through the isolating condenser and back to "B-", there is in the input circuit of the receiver (which includes the isolating condenser) a mixture of frequencies, amplitudes and phases that is impossible to predict. Some of the voltages are regenerative, some degenerative, some cause trouble at any setting of the gang condenser, while others cause trouble only over a limited range of positions of the dial (usually at the low-frequency end). When oscillation troubles result after replacing an I.F. transformer there are 2

logical remedies possible:

(1) Reduce the common impedance across which the feedback occurs.

(2) Reduce the gain of the I.F. system. As mentioned above, the Underwriters limit the value of the isolating condenser to 0.25-mf. to reduce the shock hazard. If the chassis is well protected from contact, the capacity can be increased to some extent. However, due care should be exercised to see that the condenser is of good quality and rated at not less than 400 volts (working).

A more satisfactory method of eliminating I.F. oscillation is to increase the bias on

the I.F. amplifier until the gain of the tube is reduced enough to restore stability. When it is considered that most A.C.-D.C. sets are of the very inexpensive type, and that the customers are usually not willing to pay any considerable sum for repair work (approaching 1/3 to 1/2 of the original cost) it is usually best practice to correct oscillation troubles by the fastest method—raising the bias—even though perhaps somewhat better results might possibly be obtained if more time were to be spent on the repair.

Look next month for the final article: "Servicing Oscillator Coils."

## OPERATING NOTES

### ... CANADIAN ROGERS SETS

741A.—A rather troublesome intermittent turned up in a Rogers model 741A receiver. This set played for days without any apparent defect, then suddenly would drop in volume accompanied by hum and distortion. The type 45 output tubes tested OK as did all other tubes and condensers. To make things worse, the set would often start to play normally just as I started to make some tests. The plate voltage on the 45's would drop about 50 volts whenever the trouble started. I then disconnected the 1,200-ohm bias resistor for the 45's. The set continued to play. The trouble was caused by an intermittent short at the place where the wire from the center-tap of the type 45 filaments was soldered to the resistor.

832.—An annoying trouble in the Rogers model 832 is intermittent reception due to poor contacts on the tuning condenser assembly. All movable parts should be cleaned and Russian oil applied, as well as some vaseline.

645.—In the Rogers model 645 the input transformer usually gives trouble. I find it advisable to replace the bypass condenser from the 10,000-ohm resistor to chassis. This resistor is in series with the high voltage and the primary of the output transformer. This condenser usually burns out along with the resistor so it pays to replace it and save trouble later.

951.—A common trouble in the Rogers 951 chassis is the opening-up of one of the windings of the band-pass I.F. assembly. The can should be removed and the various coils checked.

Another trouble in this set is caused by dirt on the contacts to the rotor of the tuning condenser. As the input transformer primary is bypassed with a 20,000-ohm resistor, voltage will be present on the plate of the type 27 A.F. tube, even though the primary winding may be burned-out.

ALLAN FORD,  
Portneuf Station, P.Q., Canada.

### ... FERGUSON MIDGET

In Ferguson midget receivers utilizing a 25A6 output tube, distortion after a few minutes of operation frequently may be traced to the grid leak in the 25A6 stage. Sometimes measures as much as 2 megohms. Replace this with a 1/2-megohm resistor.

WILLARD MOODY,  
New York, N. Y.

### ... RCA U-30

This model utilizes automatic motor tuning. In several models I have discovered that erratic or complete inoperation of the automatic mechanism is caused by a leaky or open motor-starting condenser connected

across the tuning motor. It is rated for intermittent use only and is frequently a cause for repair.

This unit, a 60-mf. 40-V. A.C. electrolytic is mounted directly on the tuning motor. Replacement with a manufacturer's part restores complete operation and smooth, even travel of pointer over the face of the dial.

A. W. FREYER,  
Holyoke, Mass.

### ... CANADIAN GENERAL ELECTRIC CO. RECEIVERS

S22X, S22, 42, 62, S25, S42B.—Receiver oscillation and lack of sensitivity, in these models, can be corrected on the whole by replacing R4 with a 15,000-ohm, 5-W. unit; also R1, 8,000, 1-W. It is good practice to replace these although they may be in apparently good condition. Clean and adjust the rotor springs. Rebalance the entire unit.

R44, 46.—Due to wear the gang condenser shaft frequently shifts so that the fixed and movable plates are not centrally located. Loosen the holding screws for the 3 sets of fixed plates and if necessary ream the holes to obtain greater movement. Then center the 2 sets of plates and tighten holding screws. Clean the shield and tighten the holding springs. A realignment of the set and it performs like new, if not better.

H31, 32, 51, 71.—These are large cabinet-type receivers and excellent performers. Poor tone, lack of volume, and sometimes no control of volume can in most cases be cured by replacing the 4 resistors, 18,000, 10,000, 110,000 and 14,300 ohms, located on the connection board at back of set; in case you are in doubt, these are located next to the R.F. choke, and are replaced in the order given.

In this set, to check audio-frequency transformer for continuity it is necessary to disconnect the primary to secure results, otherwise an incorrect reading will be obtained.

Set the "Local-Distance" control in the QUIET position and realign. It is advisable in most cases to remove the speaker cone and clean the housing as this unit has a powerful magnet which is liable to scale. This scale will be found obstructing the correct operation of the speaker.

K52, 53, 59, 75, K60, K57.—On these 6 types, motorboating and oscillation are the most common breakdowns. The oscillating condition is quite easily checked by touching the cap of the 2A7 and in most cases reception will be obtained. It is advised that the dual condenser be replaced entirely; it will prevent a further call in a month or so.

K72, 76, 105, 107, 85, 125, 83, 87.—Hum and oscillation obtained on these sets can be cured by a careful survey of the wiring

diagram. For a shorted condition the defective condenser should of course be disconnected but the average are open-circuits which can be easily bridged by a condenser of the same size. Cleaning the rotor springs is also a necessity on these models.

K106, 126.—The 2 models noted here, very often break down entirely. The plates of the 80 and 5Z3 tubes getting red are an indication of the failure of C36 in the case of K106; and the condenser pack and C32 for the K126.

Oscillation can be traced to a failure of screen-grid condenser C41. Several cases of poor and intermittent reception were cured by replacing the antenna coil; however it was later found that the application of a hot iron to the terminals of this coil would have cured this complaint!

Of the later models bearing the C.G.E. monogram it would be only fair to state that tube troubles caused 85% of set failure and where possible output tubes of the metal type were replaced by glass tubes.

E Series.—In conclusion, the "E" series have been serviced for oscillation and in a number of cases the 6K7 metal tube, while OK under test will prove to be the offender. These should be checked by changing their position or by substitution.

J. HOUGHTON,  
Peterborough, Ont., Canada.

### ... CANADIAN WESTINGHOUSE 410

Several times recently, in my service work I have encountered a number of Canadian Westinghouse model 410 receivers which had a rather annoying hum only when tuned to a carrier. This trouble has always been eliminated by connecting two 0.05-mf. condensers in series across the power transformer primary and grounding the center connection to the receiver chassis. This receiver uses a type 6X5 rectifier connected half-wave.

STANLEY DAVIS,  
Vancouver, B. C., Canada.

### ... PHILCO 800 AUTO-RADIO

A "receiver dead" complaint, in connection with one of these sets, can usually be attributed to defective vibrator points which are sticking. Replace with a new unit; do not attempt to file the vibrator points. In replacing, check the buffer condensers for shorts or opens. To test them in the primary circuit of the power transformer open the transformer case cover. Sometimes handling of this receiver will throw it out of alignment, and therefore, realign it as a safety measure. Align first the I.F., then adjust both the high- and the low-frequency padders at 1,500 kc. and 600 kc., respectively.

(Author unknown.)



# REBUILDING FOR PROFIT

*Servicemen and Servicemen-dealers may find it worthwhile to suggest alterations in an existing receiver in preference to restoring it to obsolete standards. Just what steps to take and how to go about taking them—thereby turning “nuisance” jobs into profit-makers—is the subject of this article.*

CHARLES R. LEUTZ

EVERY technical trade has to contend with “nuisance” jobs and amateur competition. The carpenter is called upon to replace a broken picket, the electrician to replace a blown fuse, the plumber to fix a leaky faucet, etc. In each case the overhead expense and time involved costs much more than can be properly charged. The radio technician has the same problems, wherein the receiver defect is due to some simple trouble, easily located, such as a defective tube, dried out electrolytic condenser or partially defective paper condenser. However, in the last mentioned examples, invariably the customer is uninformed technically and accordingly a reasonable repair charge is in direct proportion to the technician’s degree of fairness and conscience.

During recent years, radio set owners have begun to realize this state of affairs and are therefore becoming inclined to give repair jobs to some acquaintance, usually some young chap with limited technical knowledge but who can be counted upon for fair treatment. If the “beginner” is unsuccessful in making the required repairs, the customer turns to an established Serviceman. In the latter case, if the estimate of repairs is low, the job is placed.

Otherwise, the customer purchases a new set, invariably some small receiver available at a low cost. Therefore everyone loses. The repair job is lost. Neither the dealer or manufacturer can make a profit on a low cost receiver. Furthermore the customer also loses as the low-cost set can only give mediocre service and for a limited time.

The “beginners” giving amateur competition cannot be eliminated. As a matter of fact they need encouragement so they can adjust themselves into established and qualified technicians. In the interval, the established technician needs more business to survive, and it can only be obtained by being in a position to offer more value than can be offered by less skilled and informed “beginners.”

A large majority of all radio Servicemen are trained to repair sets by restoring them to their original circuit conditions. This means, in many cases, restoration to conditions of obsolete engineering practice! Some radio repairmen, in fear of making mistakes, go so far as to insist on “original replacement” parts although these may be inferior to modern “universal replacement” equivalents.

*In view of this unusual condition, it is apparent that a well-informed and skilled radio technician, instead of conducting a simple repair business, can offer a complete overhaul; and the new improvements made possible by available new component parts and tubes released from time to time.*

## THE REBUILDING MARKET

Naturally these jobs are not applicable to low-cost sets. Fortunately, however, there are hundreds of thousands of high-quality multiple-tube receivers, a year or more old, that can be substantially improved. This is not due to lack of designing skill but on account of the fact that production set designers are limited by cost considerations. Technicians who familiarize themselves with technical advances in the art can definitely offer real service which can be readily marketed and executed at a profit.

Figure 1 is an elementary diagram of a typical, modern superheterodyne receiver, showing the circuit divisions and points subject to possible improvement. It is not the intention of the article to give detailed instructions covering every possible improvement. Past articles in this publication have treated the proper design of different sections of a modern receiver including aerial systems, radio-frequency amplifiers, different systems of automatic volume controls, audio-frequency amplifiers, etc. These articles can be referred-to in this connection. (See appended list of a few such articles suggested by the author.—Editor)

The most important improvements can be summarized as follows:

### A. AERIAL OR SIGNAL COLLECTOR

The prime idea is to provide an aerial system to secure maximum signal energy from the desired stations and minimum

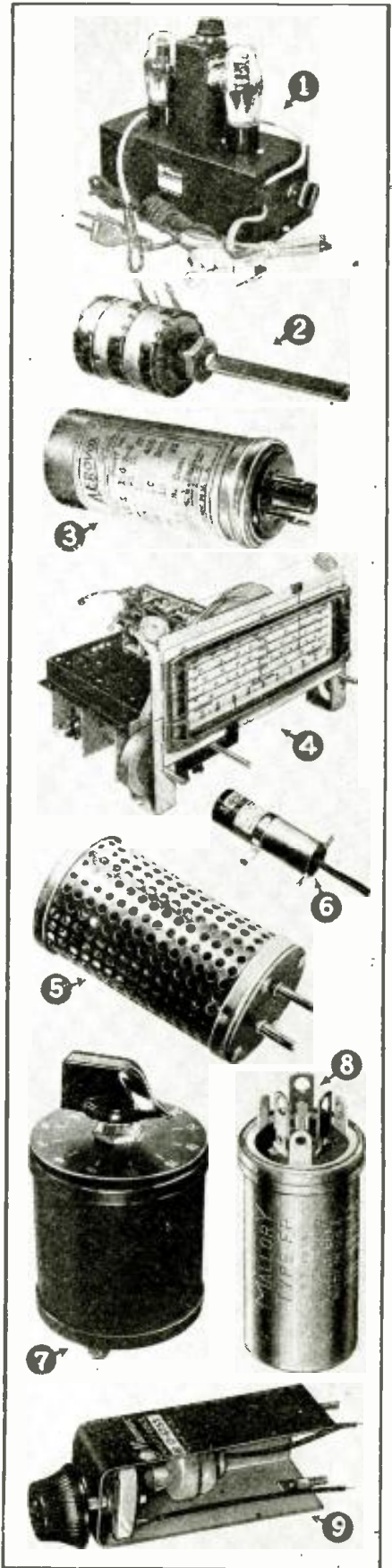
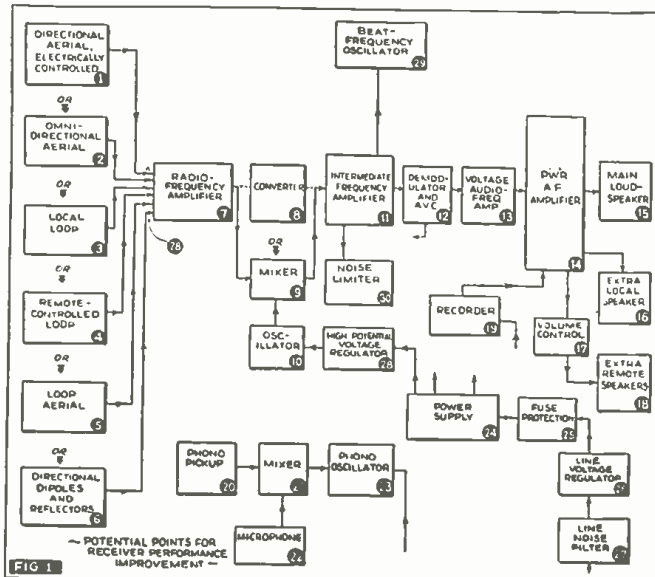

Profitable rebuilding may utilize the following components (shown above): (1) standard A.C.-D.C. phono oscillator; (2) dual volume control for push-pull audio input circuits; (3) plug-in type electrolytic; (4) factory-assembled and pre-aligned all-wave tuner; (5) line-voltage regulator; (6) tubular electrolytic; (7) output attenuator for extra loudspeakers; (8) heavy-duty dry electrolytic; and, (9) beat-oscillator transformer and trimmer.

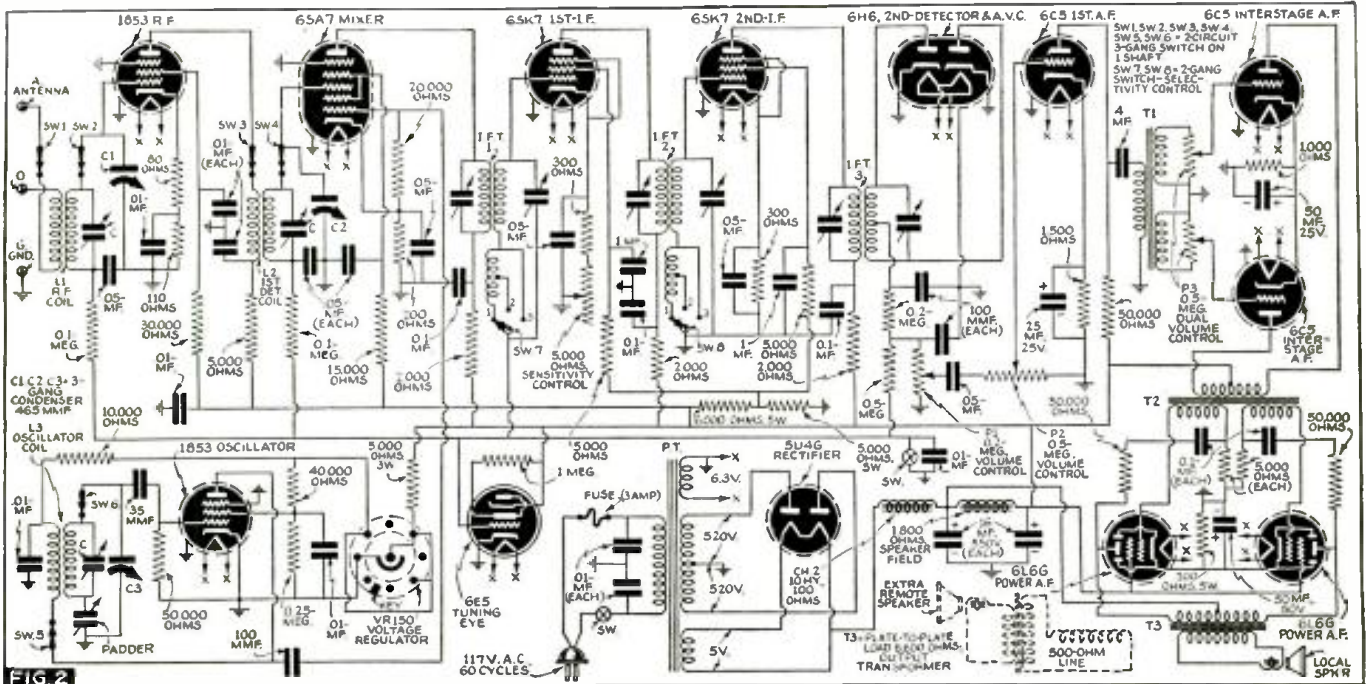

Where would you start to check up on an existing receiver? And having decided where you wanted to make changes how would you go about effecting them? The first of these questions is answered in Fig. 1 on the facing page; answers to the second question are shown in Fig. 2, above.

signal energy from possible interfering stations—together with a minimum of local noise pick-up. The different systems available are as follows:

- (1) **Directional Aerial, Electrically controlled**  
The use is primarily for long-range "DX" reception but the application requires considerable space for erection.
- (2) **Omni-directional Aerial**  
The useful application is limited to receiving locations providing a high signal energy strength from desired stations.
- (3) **Local Loop**  
This is useful in eliminating adjacent-channel interference but the application is limited to locations where the local noise level is low, for example in the country.
- (4) **Remote-Controlled Loop (See Fig. 3)**  
This application is not only useful in eliminating adjacent-channel interference but also enables removing the loop from the field of local noise interferences.
- (5) **Loop Aerial**  
Same as No. 4 but due to the larger-size loop provides increased signal-to-noise ratio.
- (6) **Directional Dipoles and Reflectors**  
The advantages are the same as under No. 4 but the application is suggested for reception of shortwaves of 30 meters or less including television and frequency modulation signals (on between 5 and 10 meters).

**B. LEAD-IN**

The method of connecting the signal collector to the receiver is very important. In Fig. 1, this is designated as item No. 28 and involves the following methods, given in the order of relative efficiency, No. 1 being the least desirable and No. 6 being the most efficient:

- (1) **Ordinary Single-Wire Lead-In**  
Provides no discrimination between signal and noise collection.
- (2) **Shielded Single-Wire Lead-In**  
Eliminates lead-in signal and noise

- (3) **Twisted or Transposed Lead-In**  
Satisfactory for low-frequency applications.
- (4) **Best Rubber-Insulated Coaxial Cable**  
Satisfactory for service down to 15 megacycles.
- (5) **Flexible Copper Braid Coaxial Cable**  
Satisfactory for service down to 30 megacycles.
- (6) **Copper Tube Coaxial Cable, Polystyrene Insulated**  
Essential for high-frequency and ultra-high frequency applications.

Types Nos. 1 and 2 should be eliminated in connection with any high-grade radio receiver installation. The choice of Nos. 3, 4, 5 or 6 depends entirely on the possible expenditure for this item, No. 6 being suggested for de luxe installations.

**R.F. AMPLIFICATION**

After covering the problem of signal collection, the next point to consider is *radio-frequency amplification*. Accordingly the antenna coupling transformer, R.F. tube and R.F. transformer must be given full consideration. By using properly-designed "iron-core" antenna input and R.F. transformers it is not only possible to secure

high gain, but to secure nearly uniform gain over the entire frequency spread involved. Furthermore such transformers will have a "broad top," conducive to high-fidelity reception.

The R.F. tube suggested is the single-ended 6SK7 for broadcast-band receivers or the 6AB7/1853 for all-wave receivers. These tubes automatically provide stable operation, high uniform gain, and have the inherent ability to handle unusually strong signals without cross-modulation or modulation distortion, due to their remote cut-off characteristics.

For a receiver designed to cover the broadcast band exclusively, there is little choice between the use of a converter tube or a mixer-oscillator. In the case of an all-wave receiver including the higher frequencies, the use of an efficient mixer and separate oscillator becomes essential to obtain uniform results over a wide range of frequencies.

Figure 2 illustrates a typical modern all-wave superheterodyne receiver circuit wherein the 1853 is used for the radio-frequency amplification, a 6SA7 as a mixer and another 1853 as the separate oscillator. These tubes are selected due to their favorable noise characteristics, high uniform gain, and stability in operation. Used as either a converter or mixer, the 6SA7 is

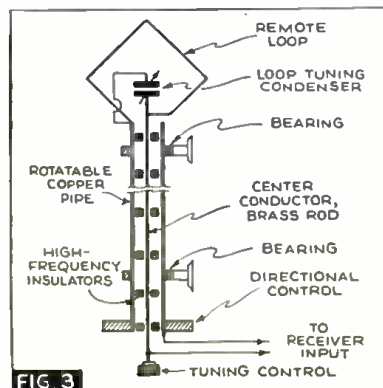

FIG 3

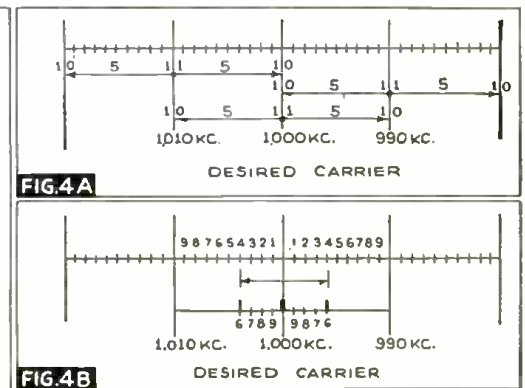

FIG 4A

FIG 4B



# 2 of 22 NEW SUPREME MODELS

practically free from frequency shift even at high frequencies. Furthermore, due to special structural design, there is a minimum of oscillator detuning by the action of A.V.C. The oscillator can be stabilized to a still higher degree by feeding the oscillator plate and screen-grid voltages from a voltage regulator tube (VR-150) as shown in the schematic diagram.

For simplification, the schematic diagram shows only 1 band position of a typical all-wave arrangement. Multiple-contact gang switches are available enabling installation of 5 or more band positions. Standard antenna input, R.F. transformer and oscillator coils are available to cover most any specified frequency range. For example one combination might consist of Longwave, Broadcast and 3 Shortwave bands. An alternative could consist of Broadcast and 4 Shortwave bands; or any other desired special arrangement.

## I.F. AMPLIFICATION

The *intermediate-frequency amplifier* (11) is one point that can be substantially improved in a very large percentage of all receivers manufactured. This important receiver section must be altered before it becomes possible to use a wide-range high-fidelity audio amplifier.

Assuming the audio amplifier provided will cover from about 30 cycles to 10,000 cycles with reasonably uniform gain, then of course, the associated I.F. amplifier must have a flat-top band-pass of at least 10 kc. each side of the carrier. Under these conditions, unless the desired signal is many times stronger than adjacent-channel signals, it is impossible to eliminate interference. Accordingly unless adjacent-channel interference is eliminated external to the receiver, it becomes necessary to sharpen the I.F. amplifier selectivity down to a point where the band-pass acceptance is about 4 kc. above and below the desired carrier. This automatically limits the audio reproduction to a maximum of 4,000 cycles. However, an A.F. amplifier that faithfully reproduces a range of from about 30 cycles to 4,000 cycles is by far preferable to a wide-range A.F. amplifier subject to distortion.

Figure 4A clearly illustrates the above problem and if the 1,010, 1,000 and 990 kc. signals are of equal strength and all modulating up to 10,000 cycles, it is impossible to properly separate one from another. If the adjacent-channel interference can be eliminated by a loop or directional aerial, the desired signal can be received and directed to R.F. and A.F. amplifiers that will reproduce the full audio range up to 10,000 cycles.

Due to the fact that such adjacent-channel interference cannot always be eliminated external to the receiver, some adjustable I.F. amplifier selectivity control becomes necessary. A very satisfactory method calls for the use of *adjustable-coupling I.F. transformers* having 3 different degrees of selectivity.

In the sharpest position of such transformers, the band-pass is narrowed to approx. 4 kc.; the result is shown in Fig. 4B. The desired, received signal (1,000 kc.) is modulated up to 4,000 cycles. The frequency acceptance from both adjacent channels is limited in each case to the frequencies of 6,000 cycles or higher (shown by the shaded area). These higher frequencies form a small part of all musical renditions and accordingly interference is drastically reduced. Type 6SK7 tubes are suggested for the I.F. amplifiers.

It will be noted from the schematic wiring diagram that no A.V.C. is applied to the last I.F. stage. This is very important as a

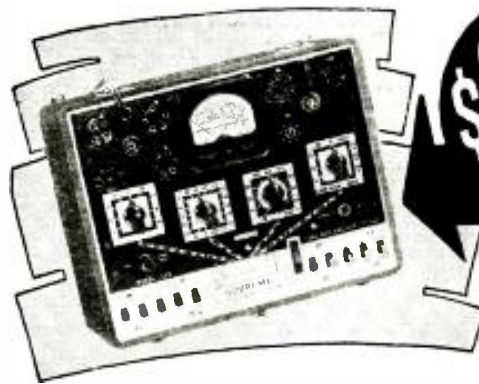

**\$29<sup>95</sup>**

Terms: \$4.00 cash and 8 monthly payments of \$3.63

**FREE**  
TUBE SETTING SERVICE FOR ONE YEAR

IN producing Model 589 there has been no compromise in the circuit design or materials. The same manufacturing methods, careful inspection and accurate calibration are incorporated in this instrument as in all other SUPREME testers. It will pay you to investigate and see this tester before you buy. Its price is the lowest at which a GOOD tube tester can be built.

**MODEL 589 TUBE AND BATTERY tester** has a completely modernized circuit. The tube test sockets are not wired directly to the circuit, but, instead, pass through the patented SUPREME Double Floating Filament Return Selector system which automatically re-connects all tube elements to any possible tube base arrangement. Due to the fact that any or all elements of each socket can be rotated to any desired position, only one socket of each type is necessary. Tests every type of tube from 1.4 volts to full line voltage at its correct anode potential under proper load. Tests separate sections in multi-purpose tubes. Checks all leakages, shorts, open elements and filament continuity with a neon lamp. A circuit insert is provided for checking noise, leakage, loose and bad connections. The battery testing circuit of the Model 589 provides the proper load at which each battery is to operate, plainly marked on the panel, for all 1.5, 4.5, 6.0, 45 and 90 volt portable radio types. The condition of the battery is indicated on an English reading scale.

This is the fastest and easiest tester to operate. Just "follow the arrows"—you can't go wrong. Roller type tube chart with brass geared mechanism lists tubes in logical numerical order. Each tester carries a one year free tube setting service. SUPREME engineering and construction PLUS the best materials the market affords, make the 589 your biggest dollar value. You will be proud to own this instrument.



**MODEL 589 TUBE AND SET TESTER** is very similar in appearance to the Model 589, and includes all the features and advantages of this instrument. In addition, it provides the following ranges:

- 0.2 TO 1500 D.C. VOLTS—5 carefully selected ranges—0/6/15/150/600/1500 volts, 1000 ohms per volt STANDARD sensitivity.
- 0.2 TO 600 A.C. VOLTS—4 A.C. ranges—0/6/15/150/600 volts. Rectifier guaranteed with instrument and fully protected from overload damages.
- 0.2 M.A. TO 600 M.A.—3 direct current ranges 0/6/60/600 allow measurement of screen, plate, "B" supply and D.C. filament loads.
- 0.2 TO 600 OUTPUT VOLTS—0/6/15/150/600—ideal for alignment. No button to hold down—no external condenser necessary.
- 0.1 OHM TO 20 MEGOHMS—4 ranges 0/200/20,000 ohms, 0/2/20 megohms. A low range at high current with 3.5 ohms center scale.

**ELECTROSTATIC—ELECTROLYTIC LEAKAGE TEST**—Sensitive calibrated 20 megohm range provides excellent leakage test of paper and electrolytic condensers. Just as the 589 is your best value in a tube and battery tester, the 589 is your best value in a combination tube tester, battery tester and set tester. Remember, you have all the features of the 589 PLUS a complete AC, DC volt, ohm, megohm, milliammeter, at a cost of only 47c per range.

Dealer Net Cash Price **\$39.50**

Terms: \$4.50 cash; 9 payments of \$4.33.



Illustrated above is the Model 589 in a counter type metal case. This model is available with option of 7" or 9" illuminated meters. Has two neon lamps for sensitive or super-sensitive tests.

**SUPREME**  
SUPREME INSTRUMENTS CORP.  
GREENWOOD, MISSISSIPPI, U.S.A.

Metal cabinets as illustrated for the Model 589 at left and 589 above are identical—can be used either in a horizontal position or vertical position by merely reversing the instrument panel. Write for information.

## A NEW BOOK ON PUBLIC ADDRESS

An important announcement about the greatest book on the subject of sound and allied subjects appears on Page 70 of this issue. **TURN TO THE ANNOUNCEMENT NOW!**

diode detector must be worked at high levels. As a matter of fact if the receiver is to be used exclusively for reception from a number of different local stations, it is advisable to eliminate the use of A.V.C. altogether.

The R.F. and I.F. amplifier circuits include decoupling filters in the plate-return and screen-grid leads.

Possible useful additions to existing I.F. circuits include a *Lamb noise silencer* (30) and a *beat-frequency oscillator* (29). The noise limiter is particularly useful in reducing automobile ignition interference encountered during shortwave reception. The beat-frequency oscillator is useful to locate

**FREE!**

**HAMMARLUND NEW "40" RADIO CATALOG**

The latest Hammarlund catalog with complete data, illustrations, drawings and curves on the entire Hammarlund line. Address Department RC-84 for your free copy.

**HAMMARLUND MFG. CO., INC.**  
424-438 West 33rd Street, New York City

# How to Become a RADIO AMATEUR



**THIS IS A FASCINATING TEXTBOOK WHICH TAKES YOU STEP-BY-STEP THROUGH EVERYTHING YOU NEED TO KNOW TO BE AN AMATEUR AND HAVE YOUR OWN RADIO STATION!**

How to learn code—how to get your license—radio theory made understandable—how to build your first transmitter and receiver—how to use those same parts in building larger equipment, etc.

There are 160 pages in the book—over 100 illustrations. It is a fine volume, cloth covered and stamped in gold. Any Radio Parts Distributor can supply you with your copy for only 75c net.

**THORDARSON**  
ELEC. MFG. CO., CHICAGO

## IN NEW YORK

The joy of your New York visit can be marred or greatly enhanced, depending upon the selection of your hotel. The Victoria has always been the choice of discerning travelers. Friendly service; bright, cheerful rooms, each with a radio, tub and shower, servitor and circulating ice-water.

Single from \$2.50—Double from \$4.00

## HOTEL VICTORIA

"At Radio City"  
7TH AVENUE AT 51ST STREET, NEW YORK  
Ronald A. Baker, Manager

Fig. 6. "Wireless" Mike or Phono Oscillator. Here's the diagram and all circuit details for that "wireless" microphone and phono oscillator you have been asking for. Nothing to it, is there? Use it with any radio set; power it from the set or from a separate A.C.-D.C. supply, as you prefer.

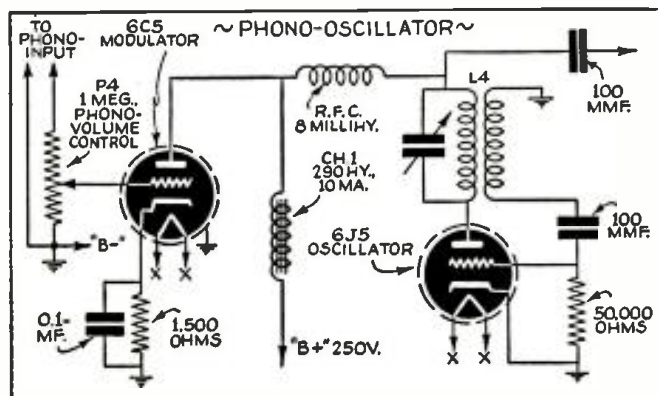

weak carriers during "DX-ing" tuning operations.

A cathode-ray visual tuning indicator is an essential for any receiver having positions of "broad" tuning. For the circuit shown, the 6E5 eye is suggested.

The 6H6 is suggested as the demodulator or 2nd-detector and A.V.C. (12). The schematic wiring diagram shows the method of using the load resistor as a 1st volume control potentiometer P.1, and associated with the 1st A.F. input volume control, P.2. Adjustment of P.1 results in a loss of gain but together with the setting of P.2 enables maintaining the most favorable conditions for "distortionless" diode detection.

In the A.F. amplifier (13) a dual volume control, P.3, regulates the input voltage to the 2nd or interstage A.F. amplifiers. The power audio-frequency amplifier (14) consists of two 6L6G's, self-biased, in push-pull class AB1, with inverse feedback applied, using a split-secondary input transformer.

The above arrangement, at first glance, may appear to have excessive A.F. amplification. However, this is not the case. First, extra A.F. gain must be available to compensate for the loss of gain at P.1. Secondly, considerable driving power is required to properly excite the power amplifier tubes, after ample inverse feedback has been applied.

Low-gain triodes (6C5) are suggested for the 1st A.F. stage and interstage A.F. amplifiers. Low-ratio, wide-range high-quality audio-frequency coupling transformers are essential for maximum results. An ideal arrangement also calls for triode power output tubes, however the proper application of such tubes calls for more space and power than available ordinarily in the average set chassis. Push-pull 6LG6's in class AB1, operated at 360 volts plate and 270 volts screen-grid, even with cathode bias, will provide an audio-frequency output of up to 24 watts.

By providing high-grade input and output transformers, the output as reproduced by a high-quality 12-in. or 18-in. electrodynamic speaker, operated under favorable acoustical environments, is free from any noticeable distortion. Where the installation involves a relatively large room, it is better practice to use two 12-in. speakers in opposite corners of the room, rather than 1 large 18-in. speaker. Where speaker cabinets are necessary, use of the bass reflex principle is suggested. Otherwise, speakers mounted right in the wall (infinite baffle) and covered with a thin tapestry will give excellent results. Extra, remote loudspeakers (preferably permanent-magnet dynamics) can be installed using a 500-ohm line and providing each speaker with a local remote volume control (17).

### POWER SUPPLY

An essential adjunct for outstanding audio amplifier performance is a well-regu-

lated power supply (24) of ample capacity. Figure 5 shows the tremendous, irregular rush of current involved, using a condenser input rectifier filter circuit, as compared with a choke input system. The schematic wiring diagram (Fig. 2) shows a choke input power supply.

Fuse protection (25) is recommended as a means to prevent serious damage by shorted filter condensers or shorted rectifier tubes. In some rural districts, sudden line voltage variations often reach abnormally high voltages, strong enough to cause considerable damage to transformers and tubes. In such locations, line supply fuses are most essential.

Less violent voltage variations affect reception and can be counteracted by installing a line voltage regulator (26).

Where an all-wave receiver is used largely for shortwave reception, interference from the power line supply is a possibility although unusual. Installation of a line noise filter (27) is a solution for this problem.

The discussion so far has been confined to the receiver and antenna systems. The sale of useful receiver accessories is in many ways more interesting and profitable than service work.

### ACCESSORIES

Phonograph records and players are becoming more popular each day and apparently the demand will be sustained for some time. Many service customers are good prospects for a record player and phono-oscillator (23). Customers that already have a small player are prospects for a higher-grade installation including an improved oscillator. Figure 6 shows a constant-current modulated phono-oscillator which is a little more complicated than ordinary oscillators, but which will give excellent results. One 6C5 and one 6J5 are required.

This brings us to the subject of recording (19), first regarded as a novelty and used principally for entertainment. It is now realized that home recorders are exceedingly valuable adjuncts in connection with studies, viz., foreign languages, diction, word pronunciation, public speech, voice culture, elocution, etc. There are many other applications including the recording of favorite programs, important speeches, etc.

The sale of a recorder automatically brings the sale for one or more microphones and one or more mixers aside from blank records, cutting needles and other accessories.

In suggesting certain types of tubes for the different circuit functions, reference has been made to basic types. Equivalents having different type numbers can of course be used.

At the conclusion of this article, reference is made to a list of articles which have appeared in the past giving detailed data on some of the subjects covered herein. In



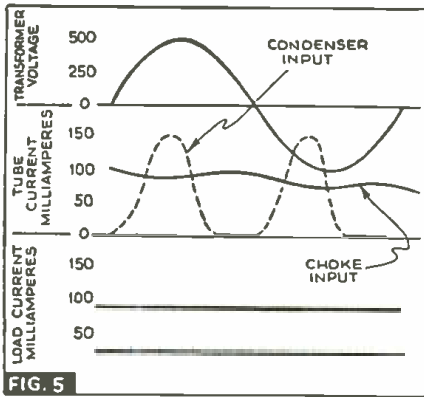

In addition to reviewing these articles, it is suggested that the service technician secure a complete set of different manufacturer's catalogs and technical data sheets covering the following:

Antenna Systems, Loops and Transmission Lines or Cables.

Iron-Core Antenna, R.F. Oscillator and I.F. Transformers.

All-Wave Factory-Assembled Tuning Units.

Standard Tube Manual.

Audio Transformers.

Power Transformers.

Loudspeakers.

Line Voltage Regulators.

Line and Other Noise Filters.

Phonograph Players.

Pickups, Microphones and Mixers.

Recorders.

Resistors, Condensers and Volume Controls.

**REFERENCES**

Past issues of *Radio-Craft* contain detailed information on the following subjects.

"The 1853 Tube," Nov., 1938.

"Anti-noise Counterpoise Antenna System," Oct., 1938.

"Ballast Resistor Tubes," Jan., 1939.

"The 6SK7 Tube," Dec., 1938.

"Principles of Noise-Reducing Antenna Systems," Sept., 1938.

"Phonograph Pickups," May and June, 1938.

"All-Direct-Coupled 30-Watt Push-Pull A.F. Amplifier," Oct. and Nov., 1939.

"A Combination DX Directional Receiving Aerial," Nov., 1939.

"Marine-izing Radio Sets," June, 1940.

"Amplifier Load-Matching Technique," March, 1940.

"Iron-Core 6," Oct., 1939.

"Combating Radio Interference," May, 1940.

"Profits in Recording," May, 1940.

"A.C.-D.C. Power Supply for Battery Portables," Oct., 1939.

"The ABC of Electronic Automatic A.C. Voltage Regulators," July, 1940.

"Specialized A.F. Tubes," July, 1940.

"A '3-in-2' A.C.-D.C. Midget Amplifier," Jan., 1940.

"Frequency-Modulated Programs on Your Present Receiver!," Jan., 1940.

Following is a list of a few components specified by make and model number which may be used in the positions shown in the schematic circuit, Fig. 2. Makes having equivalent characteristics may be employed.

**SUGGESTED COMPONENTS**

Two Meissner I.F. transformers, type 17-7414, I.F.T. 1, I.F.T. 2;

One Meissner I.F. transformer, type 16-6139, I.F.T. 3;

One oscillator coil (any make), L3;



... for the first time  
a line of TUBES  
for Heavy Duty Audio Work

**STOP!**

Hunting for Matched Tubes  
Microphonics • Hum •  
Endless Replacements  
and Call-Backs

SEE YOUR N. U. DISTRIBUTOR  
**NOW**

**DEMONSTRABLY BETTER**

Thirteen SOUND XTRA types now available. SOUND XTRA Types can be substituted for the same type in the regular line. They are DEMONSTRABLY BETTER.

In order to accomplish this outstanding performance in SOUND XTRA types modifications in construction are incorporated.

SOUND specialists have long hoped for EXTRA QUALITY TUBES engineered specifically for the requirements of SOUND work . . . they're here now in National Union SOUND XTRA Types.

For More Information Write

**NATIONAL UNION RADIO CORPORATION**  
57 STATE STREET, NEWARK, N. J.

FOR PUBLIC ADDRESS  
BROADCASTING STATIONS  
COIN MACHINES  
ELECTRIC PHONOGRAPH  
MOTION PICTURE  
AMATEUR  
AND EXPERIMENTAL WORK



**TUBES • CONDENSERS • BATTERIES • SOUND EQUIPMENT**

- One Meissner phono oscillator coil, type 17-9373, L4;
- One R.F. choke, 8 millihy., R.F.C.;
- One Kenyon choke, type T-155, 290 hy., 10 ma., Ch. 1;
- One Kenyon choke, type T-152, 10 hy., 100 ohms, Ch. 2;
- One Kenyon push-pull input transformer, type T-58, ratio 1-to-2, T1;
- One Kenyon interstage transformer, type T-54, ratio 1-to-8, T2;
- One Kenyon output transformer, type T-317, plate-to-plate load 6,600 ohms (and provided with a 500-ohm-line secondary), T3.

**MORE DATA SHEETS!**

Starting with the September issue, *Radio-Craft* will carry 4 Data Sheets on new receivers, instead of the usual 2 Sheets!

WRITE TODAY ABOUT YOUR  
**AMPLIFIER PROBLEM**  
FREE INDIVIDUAL ADVICE ON SPECIAL OR STANDARD AMPLIFIERS  
**AMPLIFIER CO. OF AMERICA**  
17 WEST 20th STREET, NEW YORK, N. Y.

**SOLAR RED-CAPS**  
Smaller Diameter Dry Electrolytics  
**SPEED Servicing**  
Write for Catalog  
**SOLAR MFG. CORP. Bayonne, New Jersey**

# AUTO-RADIO INSTALLATIONS

*On All 1940 Passenger Cars*

*Knowing just how to go about a job is the hall-mark of the proficient technician. It is these Servicemen who will benefit most from the following article, by the Service Editor of an automotive magazine, on the way to correctly install radio receivers in this season's crop of cars.*

EDWARD H. BARRY

**W**HEN INSTALLING a car radio receiver, be sure to select an aerial which will give best results with the set being used. Automobile radio sets, being very sensitive, often are designed to operate with a certain type of aerial. Some sets have separate connections for different types of aerials, while on others an adjustment must be made to compensate the set for the aerial being used. It is also easier to install some types of aerials on certain cars. Following the manufacturer's recommendations will save time in making an installation.

The recommended locations for installing noise-suppressors, condensers, ground straps and static collectors on each car are shown in the table below. After they have been installed as described, the set should be tested to see if they eliminate sufficient interference. Conditions may vary on 2 cars of the same model, and in some cases additional interference eliminators may have to be installed. The heads of the table suggest

additional places where the installation of a condenser or ground strap may do some good. To make a test, connect the lead of a bypass condenser with a capacity of 0.5-mf. to the "hot" side of the suspected unit. Ground the condenser case or the 2nd lead on a metal part of the car. When the position is found where the condenser clears up the interference, make the installation of the condenser permanent.

When installing a condenser or ground strap, all dirt or paint must be cleaned from the contacting surfaces and the connections must be tight. When a condenser is installed on a generator, be sure to connect its lead to the generator armature terminal. Should it be connected to the field terminal it will cause pitting of the voltage regulator points, which will prevent the unit from operating properly. When installing static collectors in the front wheels, the inside of the dust caps and the center of the front-wheel spindles, to give good results, must be clean and free from grease.

The installation of the receiver and speaker depends upon the make and type of set being used. The radio manufacturer's recommendations should be followed, bearing in mind, of course, that on almost every car there is some accommodation already in the car for the receiver.

**Buick**—Insert a suppressor in the high-tension lead to the center of the distributor block. Connect the lead from a condenser to the outside terminal, not the field terminal, on the generator and mount it on the generator cable clamp screw. Remove the cover from the ignition coil by inserting a thin-blade tool under the edge of the cover about 1-in. to the left of the container seam. Push the tool between the lock and the recess, twist the end of the cover and lift off the cover. Solder one lead of the condenser to the case and connect the other lead to the terminal inside the cover. Do not attempt to connect this condenser to the terminal on the outside of the coil as it will result in damaging the distributor points and will cause erratic engine performance. Install static collectors in the front-wheel dust caps. The center of the collector supplied with Buick sets is made of self-lubricating material. To fit the collector in the larger dust caps used on Buick 80 cars it will be necessary to straighten out perfectly flat the sharp, pointed prongs on the collector.

**Cadillac, LaSalle**—Install a suppressor in the high-tension lead to the center of the distributor block. Remove the air scoop from the generator and insert the lead from a condenser through the rubber grommet for the generator wires on the generator and connect the lead to the armature terminal. Mount the condenser on the generator ground screw. Install a condenser on the ignition coil as described for Buick. Peen the distributor rotor insert to lengthen it, or install a radio rotor bar. Install static collectors in the front wheels on models 50, 52, 60S, 62, and 72, making sure that the cotter pin is bent around the nut so that it will not interfere with the static collector. Bond the throttle control cable and the oil line to the dash with a ground strap and a self-tapping screw.

**Chevrolet**—An elbow suppressor and an adapter should be installed in the center terminal of the distributor block and attached to the high-tension wire leading to the terminal. Mount a condenser on the generator frame and connect its lead to the generator armature terminal. Mount a condenser on the flange of the instrument panel near the ignition switch and connect its lead to the ignition switch. Connect the lead from another condenser to the spring clip at the end of the fused lead from the dash unit with a self-tapping screw and attach this clip to the discharge terminal of the ammeter. Ground the free end of the ammeter condenser to a convenient mounting bolt on the under side of the instrument panel. Connect a ground strap from the frame to the muffler tail pipe U-bolt. Install

INTERFERENCE ELIMINATION CHART	Battery terminal grounded	Distributor suppressor	CONDENSERS										GROUNDS								
			Water temperature gauge	Oil pressure gauge	Ignition coil	Generator	Ignition switch	Voltage regulator	Ammeter	Gasoline gauge	Distributor	Clock	Circuit breaker	Front wheel	Cylinder head	Head	Dash control	Muffler	Steering column	Header hose	
Buick	N	39			12	6										36					
Cadillac	P	39			12	4										36		33			
Chevrolet	N	37				6	14				21					36	29			30	
Chrysler	P	39				5						16						31	32		
DeSoto	P	39				5						16						31	32		
Dodge	P	39				5						16						31	32		
Ford	P			25						7			11								
Graham	P	40				3	*														
Hudson	P	*	17			2	13					15									
LaSalle	P	39			12	4									36			33			
Lincoln-Zephyr	P		18	23					8		15	10		20							
Mercury	P			25						7			11								
Nash	P	38				5												31			
Oldsmobile	N	37				6						19			35						
Packard	P	38				5	*														
Plymouth	P	39				5						16						31	32		
Pontiac 8	N	37				6					20				36	27					34
Pontiac 8	N	37				6					20				36	28					34
Studebaker Champ.	P	38										16						32		*	
Studebaker Comm.	P	40				1															
Studebaker Pres.	P	40				1							9								
Willys	N	30			24	6															

Numbers refer to illustrations on following pages. Star \* indicates unit is used but not illustrated.



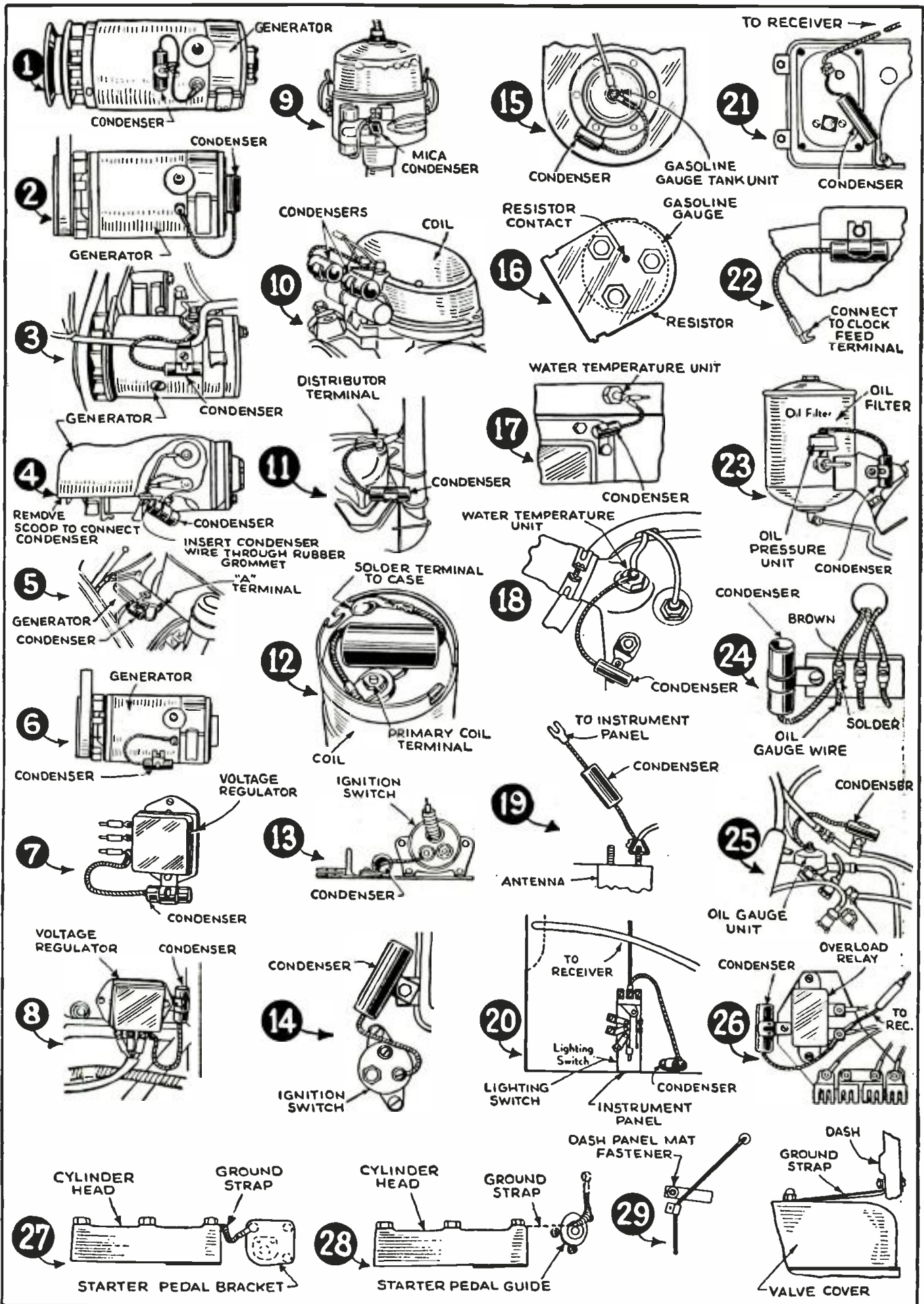

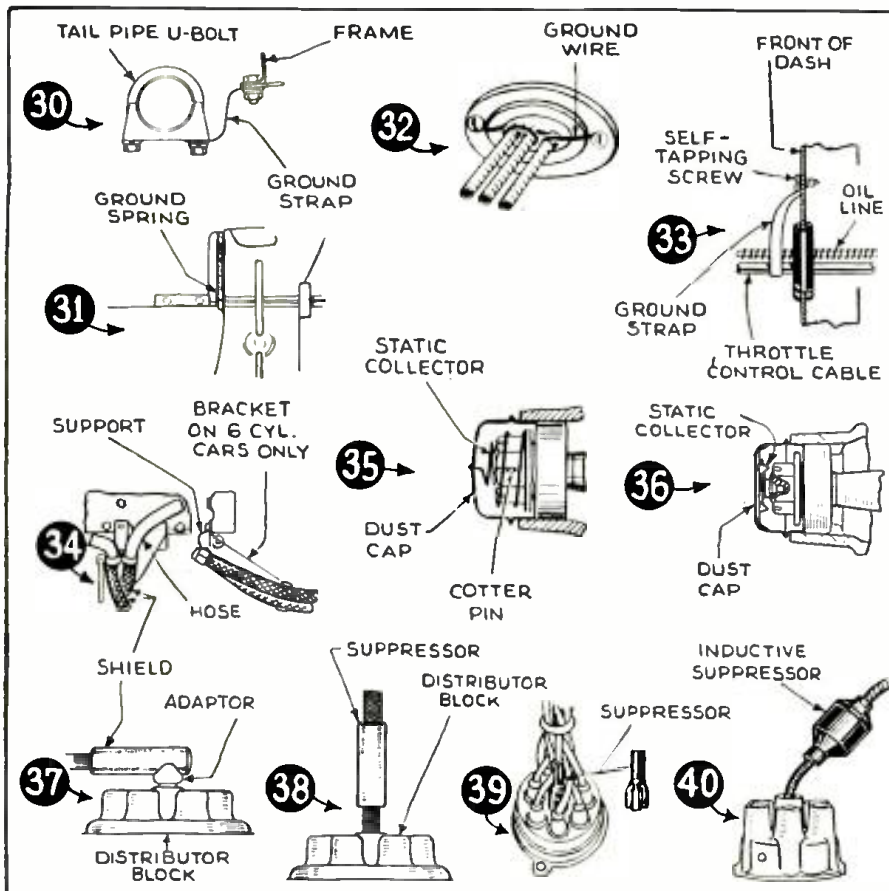

another ground strap from the rear valve cover nut to the dash. Then install static collectors in each front wheel, making sure that the cotter pin is bent around the nut so that it will not interfere with the static collector.

**Chrysler, DeSoto, Dodge, Plymouth**—Screw a suppressor on the center high-tension lead to the distributor block and plug the suppressor into the distributor cap. Mount a condenser under the generator ground lead screw and connect its lead to the "A" terminal on the generator. Remove the 3 terminal nuts and wires on the back of the gasoline gauge dash unit and assemble a resistor in place. Then replace the wires and nuts. Bond the hand brake cable, heat indicator tube, oil line, throttle, choke, and speedometer cables where they pass through the dash. Loosen the grommet holder screws and fasten a braid around the tubes and screws. Loosen the hood side panel bolts on the left side and pry out the lower hood lacing screw. Attach a hood grounding clip spring with a self-threading screw using the hole from which the screw was just removed. Then drill another hole with a No. 29 drill and insert a screw. This grounds the top and side of the hood to the cowl.

**Ford, Mercury**—Mount a condenser on the voltage regulator fastening screw and connect its lead to the bottom terminal of the regulator. Mount another condenser with a special bracket on the distributor and connect its lead to the distributor terminal nut. Connect the lead from another condenser under the center terminal on the oil gauge engine unit and mount it on the line. In some cases it may be necessary to move this condenser to the instrument board and connect the lead to the bar between the oil gauge and the fuel gauge indicators.

**Graham**—Cut the high tension lead to the center of the distributor block about 1 in. from the distributor and insert an inductive type of suppressor. Mount a condenser on

the generator under the screw holding the wiring harness and connect its lead to the armature terminal of the generator. Mount another condenser under the screw which secures the steering column bracket to the instrument panel and connect its lead to the ignition switch.

**Hudson**—Clamp a condenser under the rear left nut holding the ventilator handle guide assembly and connect its lead to the "AM" terminal of the ignition lock. Attach another condenser under one of the gasoline gauge tank unit mounting screws. Attach its lead to the gauge units terminal. Mount another condenser on the upper rear cap screw in the engine water manifold plate and connect its lead to the terminal of the water temperature gauge unit. Another condenser should be mounted on the rear of the generator with a machine screw. Connect its lead to the generator armature terminal. Install a suppressor in the high-tension lead to the center of the distributor block. Mount a ground strap between the left rear cylinder head bolt and the dash, fastening it to the dash with a metal screw and a lock washer.

**Lincoln-Zephyr**—Install 2 suppressors with special brackets on the distributor and connect the leads under the terminal nuts. Install a condenser on the overload relay, which is mounted on the dash inside the car and over the steering column. Connect its lead to the same terminal on the relay as the battery lead of the radio set is connected. Mount a condenser on the rear of the oil filter bracket and connect its lead to the terminal on the oil gauge. Mount another condenser under one of the gasoline gauge tank unit bolts and connect its lead to the gauge terminal. This is accessible under a metal cover beneath the spare tire in the rear compartment. Mount another condenser with a special bracket under one of the cylinder head bolts and connect its lead to the water gauge terminal. Another

condenser should be fastened to the voltage regulator mounting bolt and its lead connected to the "BATT" terminal.

**Nash**—Insert a suppressor in the high-tension lead to the center of the distributor block. On Ambassador cars it will be necessary to insert a suppressor in both center leads. Mount a condenser under the generator ground lead screw and connect its lead to the generator armature terminal. Attach 2 hood grounding clip springs under one of the hood lining screws to ground the top and side of the hood to the cowl.

**Oldsmobile**—An elbow suppressor and an adapter should be installed in the center terminal of the distributor block and attached to the high-tension wire leading to the terminal. Mount a condenser on the ground lead screw on the generator frame and connect its lead to the "A" terminal on the generator. Attach the lead from another condenser to the ammeter terminal to which the radio set wire is connected and ground the condenser with another lead to the upper flange of the instrument panel. Install static collectors in the front wheels, making sure that the cotter pin is bent against the nut so that it will not interfere with the collector.

**Packard**—Cut the high tension lead to the center of the distributor and insert a suppressor in it. Mount a condenser under the ground lead screw on the generator and connect its lead to the generator "A" terminal. Mount a condenser on the instrument board flange and connect its lead to the feed line on either the ignition switch or the ammeter, depending upon where it does the most good. Interference from an electric clock can be eliminated by connecting an additional condenser to its ammeter terminal.

**Pontiac**—An elbow suppressor and an adapter should be installed in the center terminal of the distributor block and attached to the high-tension wire leading to the terminal. Mount a condenser under the head of the ground screw on the side of the generator case and connect its lead to the generator armature terminal. Mount another condenser under the left-hand instrument board mounting stud nut and connect its lead to one of the accessory terminal screws at the extreme front end of the lighting switch. Install static collectors in the front-wheel inner dust caps, making sure that there are no burrs around the center hole in the wheel spindle which would cause excessive wear of the contact button. Bolt a ground strap to the cylinder head with a special screw and lock washer. On the 6-cylinder cars connect the other end of the ground strap to the dash under the upper starter pedal bracket. On the 8-cylinder cars drill a 0.199-in. hole through the dash 2 1/8-ins. above the upper starter pedal guide screw and connect the other end of the ground strap to the dash at this point with a self-tapping screw. Spot face around the hole to obtain a good ground connection. If the car is fitted with a "Fore-'n'-aft" underseat heater it will be necessary to install a heater hose shielding. To make an installation, slip 2 pieces of braided metal loom over the hose and stretch them lengthwise until they are tight on the hose. Remove the clamp bolt from the double clip which supports the hose at the cylinder head and scrape away all paint and dirt from between the support and the clip, and between the support and clamp bolt nut to form a good ground.

**Studebaker Champion**—Cut the high-tension lead to the center of the distributor block and install a resistor type of suppressor in it. Mount a condenser under the generator ground lead screw and connect its



lead to the generator armature terminal. Remove the 3 terminal nuts and wires on the back of the gasoline gauge dash unit and assemble a resistor in place. Then replace the wires and nuts. Ground the controls that pass through the 2 rubber grommets in the dash by using a braided shielding. Place one end of the shield under the screw on one side, make a turn around each cable and fasten the other end of the shielding under the other screw. Drill a 1/8-in. hole in the steering column jacket just outside the engine bulkhead. Also drill a 1/8-in. hole through the bulkhead just above the steering column and fasten a ground strap between the 2 points with self-tapping screws.

**Studebaker Commander**—Cut the high-tension lead to the center of the distributor and install a resistor type of suppressor in it. Mount a condenser under the generator ground lead screw and connect its lead to the generator armature terminal.

**Studebaker President**—Cut the high-tension lead to the center of the distributor and install a resistor type of suppressor in it. Mount a condenser under the generator ground lead screw and connect its lead to the generator armature terminal. Connect one side of a small mica condenser to the battery terminal on the distributor and ground the other terminal of the condenser under the distributor condenser mounting screw.

**Willys**—Install a suppressor in the center terminal of the distributor block and connect the high-tension lead to it. Mount a condenser on the generator ground lead screw and connect its lead to the generator armature terminal. Attach another condenser under a junction block mounting screw and solder its lead to the terminal of the brown wire leading to the oil gauge. Be sure that the floor board holt heads are tight enough to make a good electrical contact.

*This article has been reprinted by permission of Motor, the automotive business magazine, and with the cooperation of P. R. Mallory & Co., Inc.*

**FIX THAT RADIO!**

THE deadline is 2 hours from now . . . the set is on the bench . . . you turn it on, watch the ammeter indicate too much current consumption, flip the receiver switch "off" to prevent damage. You get out the ohmmeter, check the resistance from the screen-grid to chassis of the output tube, and the result indicates a short-circuit. Next, you take a look around and see that there is a filter condenser with some white stuff leaking out of the top of it. You put the ohmmeter here, with one side of the condenser disconnected from the receiver wiring. The condenser is shorted, you find, and another is put in its place.

You turn the set on again, and this time the power consumption is not too high, is in fact normal. But the tone is none too good, being lacking in bass response, which leads you to the conclusion that, since the reactance of a condenser varies inversely as the frequency, the opposition to audio voltages must be too high at the low frequencies, indicating high reactance and too-low capacity. So you disconnect the other filter condensers and test them by putting the ohmmeter on the 100,000 Ohms range, watching the meter needle flip up as the condenser takes the charge, watching it gradually recede to zero, if the condenser is a good one. The amount of kick the meter needle receives is proportional to the capacity and the quality of the condenser, which may be compared with a good one. A new set of condensers, you find, results in improved tone and much less hum.

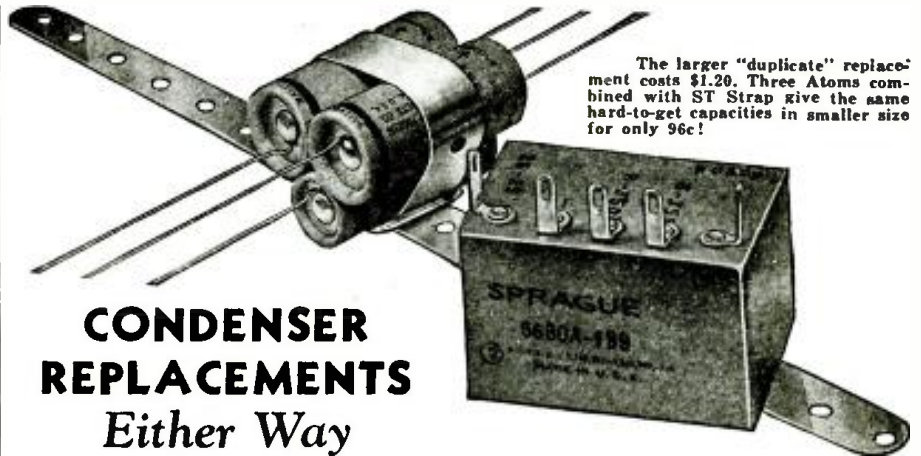

The larger "duplicate" replacement costs \$1.20. Three Atoms combined with ST Strap give the same hard-to-get capacities in smaller size for only 96c!

It pays to try Sprague for any exact duplicate condenser requirement. As leading suppliers to the largest set makers, we can supply almost any needed unit promptly—and identical to the original specifications.

But don't forget, you can save on most hard-to-get replacements, simply by combining several Sprague Atom midget dries. Just strap 'em together (see picture) with Sprague ST Mounting Straps—supplied free—and you have a smaller, better unit and actually at less cost than an exact duplicate! Using ST Straps, you can make up almost any combination of capacities and voltages using standard Sprague Atoms stocked by every Sprague jobber. Big new catalog of Sprague Condensers and Koolohm Resistors FREE.

**NEW MANUAL ON RADIO INTERFERENCE**

Just the book you've been looking for. Complete—fully illustrated . . . tells what to do, how to do it to eliminate all types of man-made radio noise. 25c net.



**SPRAGUE**

**CONDENSERS  
KOOLOHM RESISTORS  
TEST EQUIPMENT**

**SPRAGUE PRODUCTS CO. NORTH ADAMS, MASS.**

There is now almost pure D.C. on the plates of the tubes. But the A.V.C. is "out," and a high-resistance voltmeter indicates an open A.V.C. circuit, which is repaired by replacing the resistor in the negative line. A glance at the clock, and sigh relievedly—you made it on time!

WILLARD MOODY,  
New York, N. Y.

**FEATURES IN AUGUST  
RADIO & TELEVISION  
MAGAZINE**

March of Radio  
International Radio Review  
3-Tube Loop B.C. Receiver  
—Chas. R. Leutz

5, 10 and 20 Meter Receiver for "Hams" and "Fans"—Harry D. Hooton, W8KPK  
Beginners' 2-Tube Receiver  
For Hams—a 2 1/2 and 5 Meter Transmitter  
—Milton Meyrowitz

Frequency Modulation—How It Works  
—Ricardo Muniz, E.E.

New F.C.C. Rules for Radio Amateurs  
How to Plan the Radio Amateur Transmitter  
Getting the Most from Your "Portable" Receiver—H.W. Secor

Television News—  
The new RCA 2" Iconoscope Makes Amateur Television Practical!  
Radio "Hookups"—Including Puzzle Diagram  
Easy Set-Building—  
A Flea-powered Transceiver  
—H. G. Cisin, M.E.

Question Box  
Radio Kinks  
Latest Radio Patents  
Newest Radio Apparatus

**TOPS!  
in EYE APPEAL!  
EAR APPEAL!!  
PRICE APPEAL!!!**



It has everything you need to sell more records. Quality crystal pickup self starting silent rim drive motor (also in AC-DC and 25 cycle), high fidelity amplification and speaker and retails at only \$11.95. Dealers write for attractive proposition. Service men can use the PORTABLE MODEL for frequency test records.

**MUSIC MASTER MFG. CO.**  
508 S. Dearborn St. Chicago, Ill.

**DIRECT-COUPLED AMPLIFIERS**



Write For Complete Details and Attractive Proposition  
**AMPLIFIER COMPANY OF AMERICA**  
35-45 WEST 97TH STREET NEW YORK CITY, NEW YORK

SENTINEL MODEL 217-P PORTABLE RADIO SET

6-Tube Superhet.; A.C.-D.C. and Battery Operation; Automatic Volume Control; Built-In Loop Antenna; Sliderule-Type Dial; Underwriters Approved; Broadcast Band (Range 535 to 1,730 kc.); Inclined-Panel Leather Case Stage of R.F. Amplification; 5-In. P.M. Dynamic Loudspeaker.

ALIGNMENT PROCEDURE

Remove chassis from cabinet. Place loop antenna in the same position it would be when the chassis is in the cabinet.

I.F. STAGES

Set receiver dial to any point where no interference signal is received. Feed a 455-kc. signal from the test oscillator to the grid cap of the 1A7GT tube

through a 0.2-mf. dummy antenna condenser. Do not remove the grid cap. Adjust each of the 2nd I.F. transformer trimmers for maximum output and each of the 1st I.F. transformer trimmers for maximum output. (See diagram showing locations of trimmers.)

1,730 TO 540 KC. BAND

When adjusting the 1,730 kc. oscillator trimmer and the 1,400 kc. antenna trim-

mer, do not connect the test oscillator directly to the loop. Instead, couple the test oscillator to receiver loop by making a loop consisting of 5 to 10 turns of No. 20 to 30 size wire wound on a 3-in. form and attached across the output of the test oscillator. Place this test oscillator loop near the set loop and be sure that neither moves while aligning.

Set the receiver dial to exactly 1,730 kc. and feed a 1,730 kc. signal to the loop antenna of the receiver. Adjust the 1,730 kc. oscillator trimmer for maximum output. Then set the receiver dial to approximately 1,400 kc. Feed a 1,400 kc. test signal into the receiver loop antenna and adjust the loop trimmer for maximum output, rocking the gang condenser throughout this operation.

Note that this portable, unlike most portables, incorporates a stage of R.F. amplification. When an external aerial is used a good ground connection must be made.

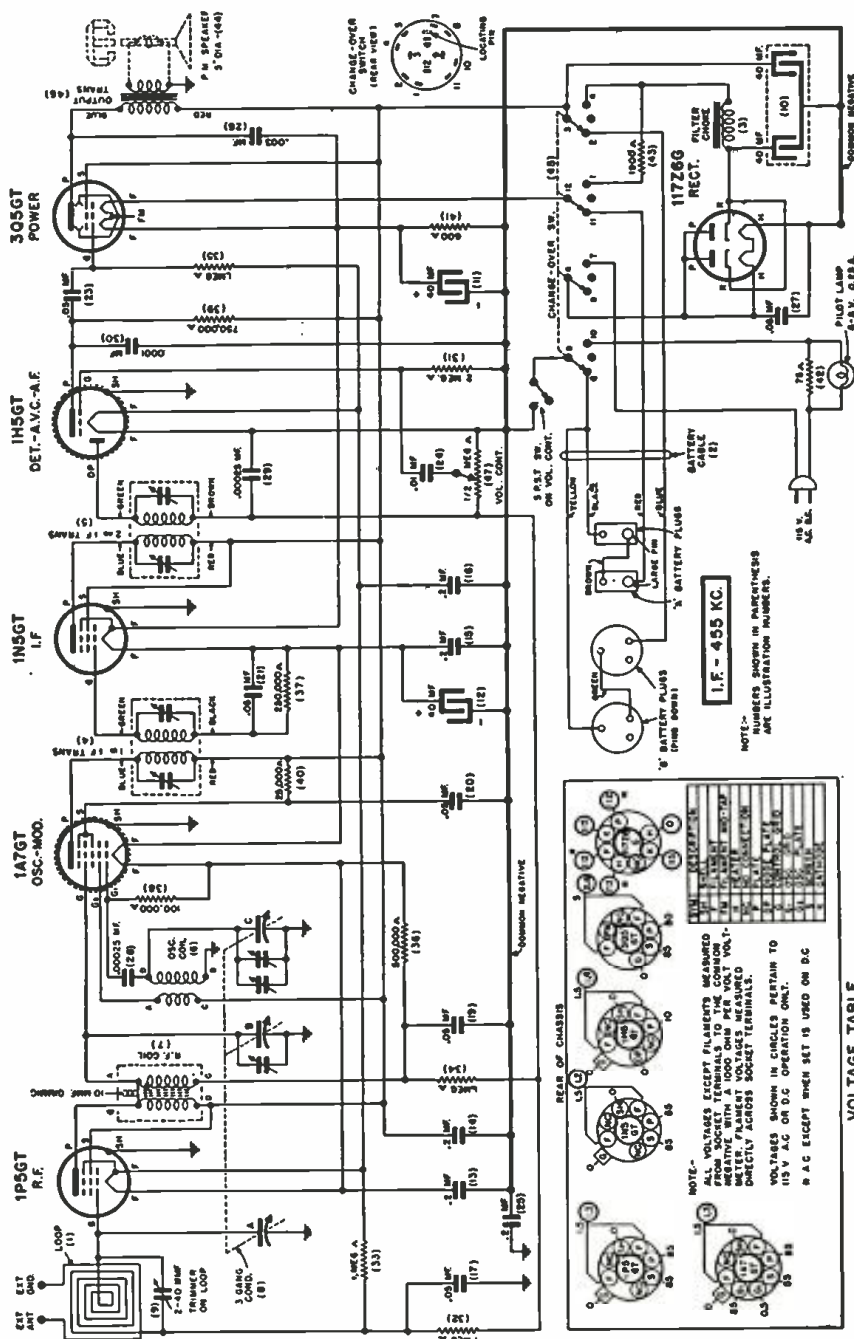

Complete schematic diagram and operating voltages of Sentinel 217-P receiver.



Sentinel model 217-P 3-way portable radio set.

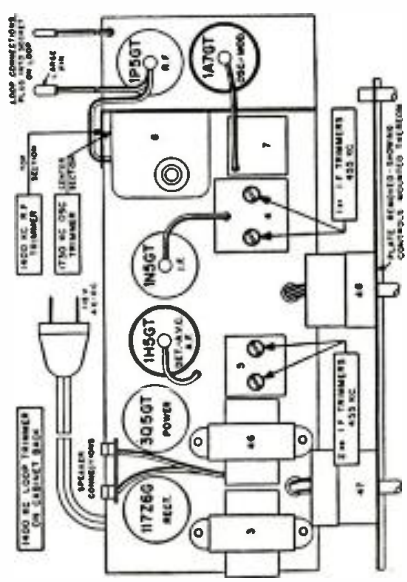
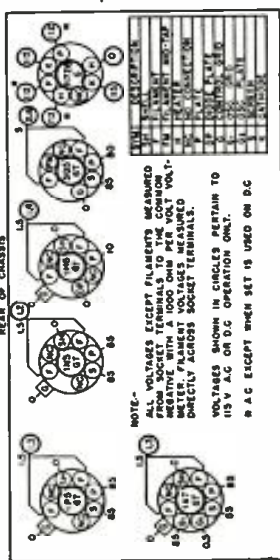

Diagram showing locations of trimmers and components.



# Radio Service Data Sheet

## BELMONT MODEL 678 AUTO-RADIO SET

6-Tube Superhet.; 6-Button Automatic Remote Tuner Unit; Automatic Volume Control; Range 535 kc. to 1,565 kc.; Synchronous-Type Vibrator; Single Stud Mounting.

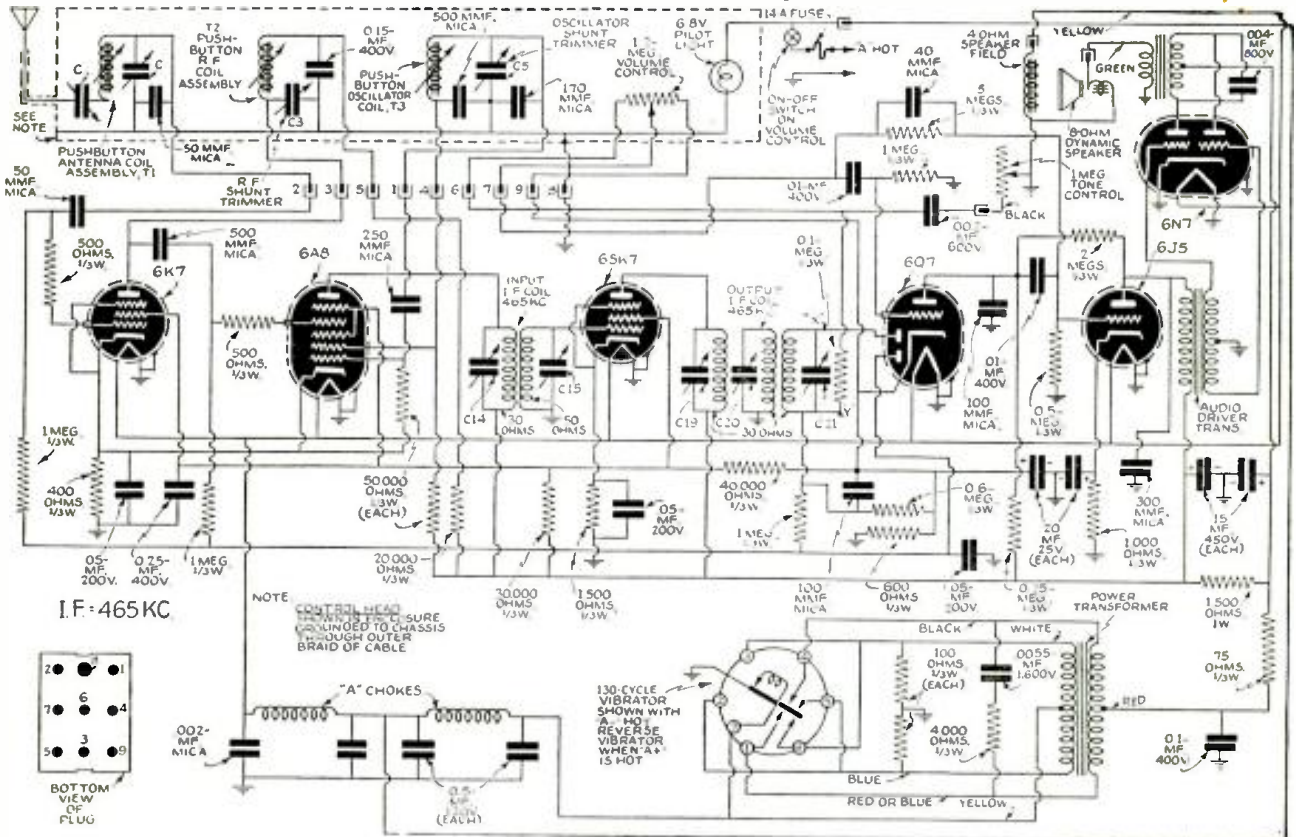

Fig. 1. Complete schematic diagram of the Belmont model 678 auto-radio receiver.

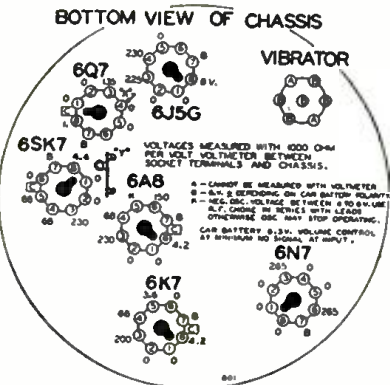

Fig. 4. Bottom view of chassis giving socket voltages.

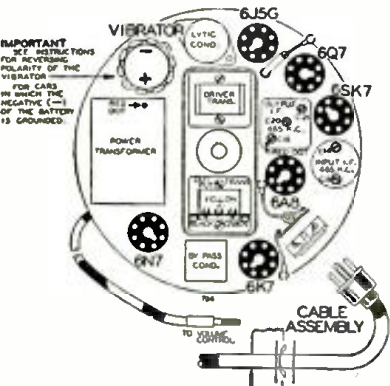

Fig. 2. Chassis view showing locations of trimmers and components.

### ALIGNMENT PROCEDURE

Turn volume control to maximum for all adjustments. Connect radio chassis to ground post of signal generator with a short, heavy lead. Connect dummy antenna in series with generator output lead;—0.1-mf. for the I.F. band and a 125 mmf. for the broadcast band. Use an output meter across the primary of the output transformer. Allow chassis and signal generator to heat up for several minutes.

### I.F. ALIGNMENT

Feed a 465-kc. signal to the grid of the 6SK7 I.F. tube. Set dial at 1,400 kc. Adjust trimmers C19 and C20 for maximum output. To align this output I.F. unit without using cathode-ray oscilloscope, a 10,000-ohm resistor must be shunted across the diode tuned circuit as indicated by points X and Y on the schematic (Fig. 1) and in Fig. 4. Trimmer C19 is identified by a red dot on top of the I.F. can.

After alignment of these 2 trimmers, remove the 10,000-ohm resistor and align trimmer C21 for maximum output. Do not readjust trimmer C19 or C20 after the resistor has been removed. Shift the signal generator lead to the control-grid of the 6A8 and adjust trimmers C14 and C15 for maximum output.

### BROADCAST BAND

Feed a 1,565-kc. signal to the antenna lead with the set dial adjusted to 1,565 kc. Adjust trimmer C5 for maximum output. Reset the dial to 1,400 kc. and adjust trimmers C1 and C3 for maximum output using a 1,400-kc. test signal. Finally, reset the dial to 600 kc. and adjust trimmer C2 using a 600-kc. test signal in the antenna lead. Maximum gain for this adjustment depends on the capacity of the antenna system of the car in which the radio receiver is installed.

Power consumption is 7.7A. at 6.3V. No suppressors required on the spark plugs; only a distributor suppressor is needed. The output I.F. coil has 3 tuned circuits giving superior band-pass qualities and selectivity as compared to the conventional 2-tuned-circuit coils. Antenna, R.F. and oscillator circuits are permeability tuned, offering automatic tuning applications that are both accurate and stable. The entire coil assembly is mounted in the Remote Tuner control head being connected to the oscillator and R.F. circuits by an R.F. transmission cable.

The R.F. oscillator, and I.F. and A.F. amplifiers, including the power supply, are contained in the speaker case.

This unit has been designed to facilitate servicing.



Fig. 5. Belmont auto-radio model 678. Note Remote Tuner at right.

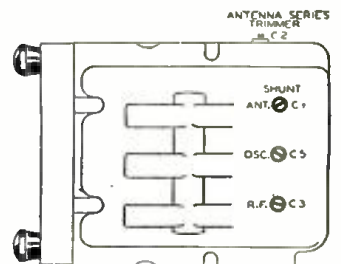

Fig. 3. Bottom view of remote tuner

★ ★ ★ **THREE STAR RADIO VALUE**  
*You receive valuable subscription to **RADIO-CRAFT***  
**PLUS A FREE COPY of 1940 Radio-Television Reference Annual**

WITH our compliments, we want to send a copy of the 1940 RADIO-TELEVISION REFERENCE ANNUAL to you FREE, if you will simply take advantage of RADIO-CRAFT magazine's special subscription offer NOW. This offer is being made for a limited time only.

The 1940 RADIO-TELEVISION REFERENCE ANNUAL has 68 pages, large size 8½ x 11½, with over 170 illustrations. The contents of this book has never appeared before in handy book form. Its pages cover practically every branch of radio sound, public address, servicing, television, construction articles for advanced radio men and technicians, time and money-saving kinks, wrinkles, useful circuit information, "ham" transmitters and receivers, and a host of other data.

The Annuals have always been regarded as a standard reference work for every practical branch of radio operation and service. This 1940 edition ably sustains this reputation. Every radio man wants a copy of this valuable book. Just as this book will be of unquestionable value to you, so, too, will every monthly issue of RADIO-CRAFT. This magazine brings you big value every month. It keeps you intelligently informed about new developments in radio and television. You want the news, want it fully but concisely, want it first—that is why you should read RADIO-CRAFT regularly.

This very special offer is made for just one purpose—we want you as a regular subscriber. The Annual, whose contents appears at the right, is not sold, but a copy is FREE to you if you subscribe now.

**SAME SIZE AS  
RADIO-CRAFT**

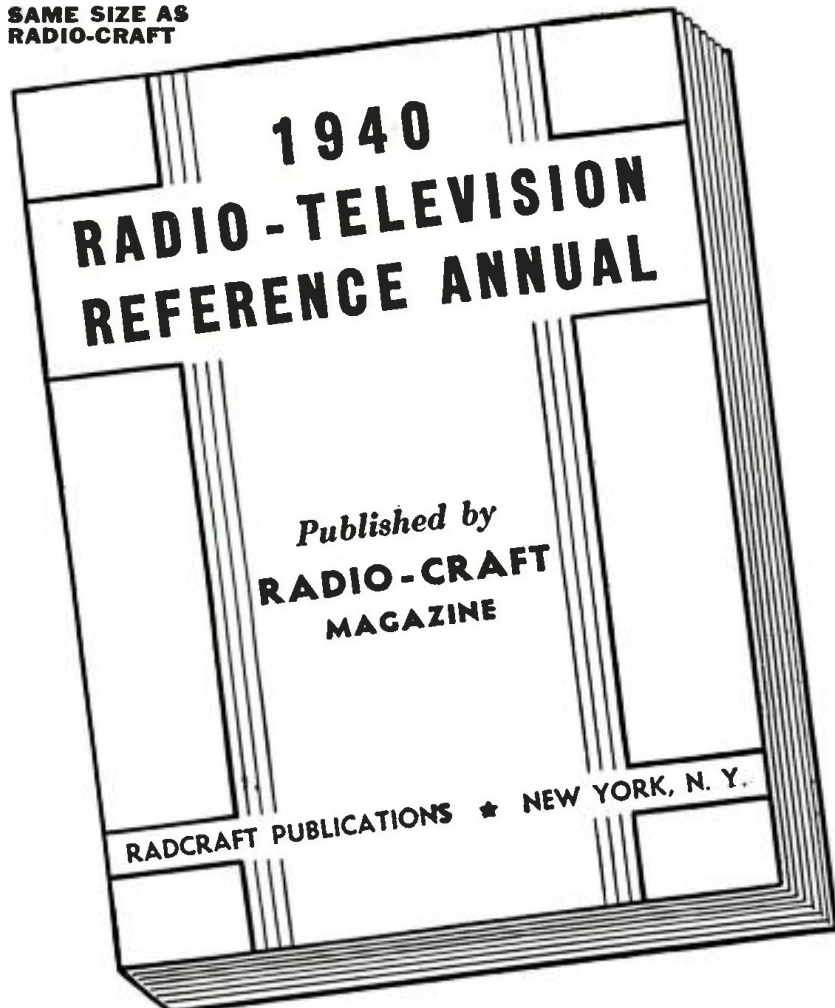

**THIS COUPON BRINGS YOU THE ANNUAL**

**RADIO-CRAFT • 20 VESEY STREET • NEW YORK, N. Y.**

Gentlemen: Enclosed you will find One Dollar for which enter my subscription to RADIO-CRAFT Magazine for Eight Months. Send me **ABSOLUTELY FREE** and **POSTPAID**, my copy of 1940 RADIO-TELEVISION REFERENCE ANNUAL.

This is a new order  Extend My Present Subscription

NAME ..... ADDRESS .....

CITY ..... STATE .....

**DON'T DELAY — MAIL TODAY!** RC-840

**Read the summary of contents  
in this FREE BOOK!**

THE 1940 RADIO-TELEVISION REFERENCE ANNUAL contains a collection of the best and most important articles. Covering as they do nearly every branch of radio, they form a handy reference works. In addition, many time and labor-saving kinks, circuits and wrinkles, tried and tested by practicing Servicemen, experimenters and radio fans have been included. This book cannot be bought anywhere at any price. Yet it is yours by merely subscribing. Use the convenient coupon below.

**BEGINNER'S SIMPLE INEXPENSIVE  
CONSTRUCTION ARTICLES**

Beginner's Breadboard Special - a 1-Tube High-Gain All-Wave Receiver—Wiring Pointers for Radio Beginners—A Watch Charm Size 1-Tube Set—Beginner's Simple Volt-Milliammeter—Making a 1-Tube Broadcast Loop Receiver—A.C.-D.C. Power Supply for Battery Portables—A 1-Tube Short-Waver with Band Coil Switching.

**MORE ADVANCED SET CONSTRUCTION**

The "High-Seas 4" Broadcast Lamp Radio—How to Build a 6-Tube 1.4-Volt Short-Wave Superhet for the "Ham" or Short-Wave Fan—Build the "Lunch Box 5" Super Set - a Broadcast Battery Portable—How to Build a Plug-Together 8 Tube Broadcast Set—The "5-In-4" All-Wave Radio for A.C. Operation—An Easily-Built 3-Tube Midget Broadcast Superheterodyne Receiver.

**THE SERVICEMEN'S SECTION**

Bass Tone Control—Simplified Variable Selectivity—Practical Servicing Pointers—Servicing Universal A.C.-D.C. Receivers—Killing the "Intermittent" Bug—A Service Shop A.C. to D.C. Power Supply—Sideline Money for Servicemen—Adding A.V.C. to any Screen-Grid T.R.F. Receiver—Iron Particles in Speaker Air Gap.

**TEST INSTRUMENTS**

A Useful Neon Lamp Tester—An Inexpensive Output Meter—Making Milliammeter Multipliers—Home-Made Frequency Modulator—The Busy Servicemen's V.T. Volt-Meter.

**PUBLIC ADDRESS AND AMPLIFIERS**

Build this Combination A.C.-D.C. Radio and Inter-Communicator—Speaker Placement in P.A. Work—The Design and Construction of an Inexpensive All-Push-Pull 10-Watt Amplifier—Obscure Sources of Hum in High-Gain Amplifiers—How to Build a High-Fidelity 5-Watt Versatile Amplifier.

**"HAM" SECTION**

Ultra-High Frequency Antennas—The Beginner's Low-Cost Xmitter—Modulator Meter—Phone Monitor—The Beginner's "Ham" Receiver—2½ Meter Acorn Transceiver.

**TELEVISION**

How to Build a 441 Line T.R.F. Television Receiver—Useful Notes on Television Antennas.

**MISCELLANEOUS**

Simple Photo-Cell Relay Set Up—Making a Burglar Alarm—How to Build A.C.-D.C. Capacity Relay—How to Make a Modern Radio Treasure Locator.

**USEFUL KINKS, CIRCUITS AND WRINKLES**

Making a Flexible Coupler—Two-Timing Chime—A Simple Portable Aerial—An Improvised Non-Slip Screw-Driver. NOTE: The book contains numerous other useful Kinks, Circuits and Wrinkles, not listed here.

(approximately)

**45 ARTICLES**

(approximately)

**170 ILLUSTRATIONS**

**68 BIG PAGES**

**RADIO-CRAFT**  
**20 VESEY STREET**  
**NEW YORK, N. Y.**



# A LOW-COST SIGNAL CHASER — Plus

*"While the instrument was designed primarily for beginners, and Servicemen who operate on a small scale, the advanced technician will also find this tester capable of promptly locating the trouble in possibly 90% of all ordinary calls." The instrument here described is not only a signal chaser but also functions in other capacities.*

C. RASK LATIMER

**N**EW Servicemen are often discouraged and handicapped by not being able to afford a complete set of modern test instruments. Accordingly there is a decided demand for substitute low-cost instruments really capable of useful functions.

The instrument to be described in this article can be built at a very reasonable cost. The functions include signal chasing at either radio or audio frequencies, voltage indication, voltage polarity, high-resistance continuity, low-resistance continuity, interference search, hum search and many other applications that will be apparent to resourceful technicians.

## USES

Figure A is a view of the complete instrument which only occupies a space of 10 x 5 x 3 ins. deep, and which is entirely self-contained and -powered. Using the versatile 1D8GT tube, diode detection, triode voltage amplification and pentode power audio amplification are all available within the single tube envelope. The tube requires one 1½-volt "A" cell and two 51-volt "B" batteries, and there is room for these within the case. Accordingly the instrument is useful at points where ordinary 110 volt 60 cycle A.C. may not be available to operate standard test apparatus. An example would be the field servicing of auto, marine or farm receivers which operate from 6, 12 or 32 volts D.C. or 110 volts D.C.

While the instrument was designed primarily for beginners, and Servicemen who operate on a small scale, the advanced technician will also find this tester capable of promptly locating the trouble in possibly 90% of all ordinary calls. This is especially true if the receiver tubes are first tested.

There are some limitations to the applications. The R.F. search cannot be expected to pick up very feeble signals as there is no R.F. amplification. However the output from any R.F. or I.F. stage can be detected and noted. Voltage indication below 65 to 90 volts cannot be secured as the neon lamp requires that initial voltage before it can strike the arc. For R.F. search ordinary prods and leads are suggested, same being connected in place, and the operator's hands removed to prevent disturbance of the circuit. If desired, a coaxial cable type R.F. prod can be substituted. If the matter of circuit unbalance is important, the "hot" R.F. prod can be connected through a 100 mmf. condenser or series 1-megohm resistor.

In spite of the 2 limitations admitted, the useful functions are numerous and offset the small disadvantages. The instrument is not intended to replace precision equipment.

## CIRCUIT

Figure 1 gives the complete schematic wiring diagram showing the 1D8GT tube circuit used which consists of a diode detector, triode 1st A.F. stage (resistance coupled), and a pentode 2nd A.F. or power output stage. Bias for the pentode control-

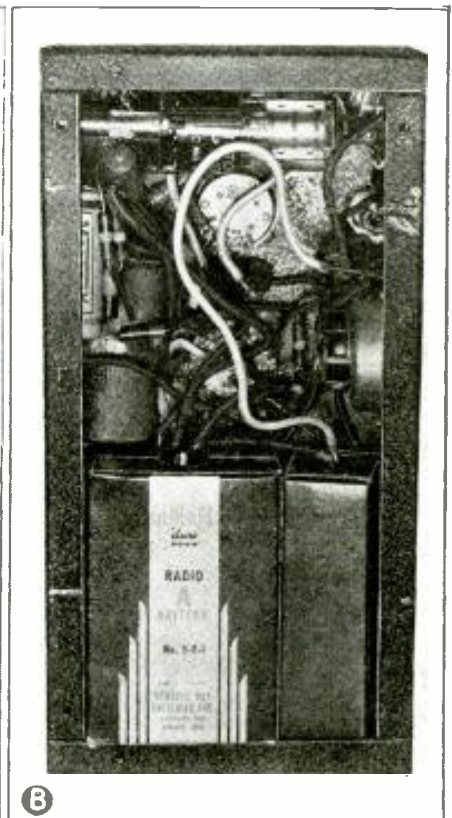
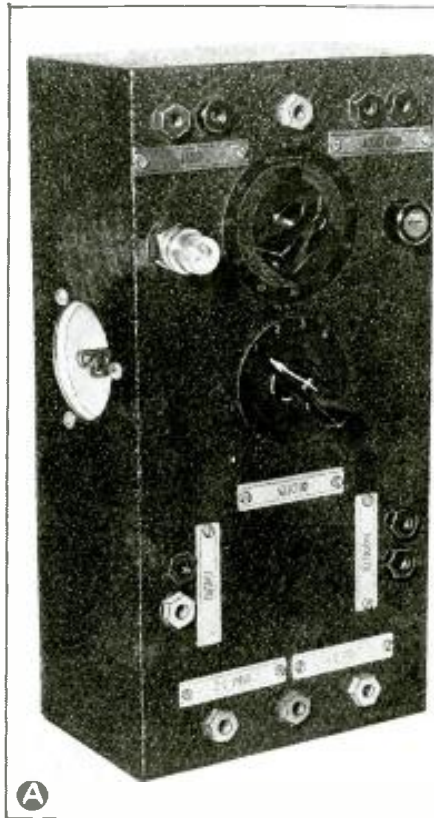

(A) Front view of the Low-Cost Signal Chaser-Plus. The recessed power-cord receptacle is seen on the left side. To put this "signal chaser-plus" into full operation you need only headphones. (B) The rear view suggests the ease of construction.

grid is obtained from a series resistor, R10, in the "B"-negative lead. Tip-jacks, 12 in all, are provided to make the necessary connections. In addition a 3-circuit 4-position selector switch is provided to secure the circuit changes required.

For the low-resistance continuity test, the headphones and "A" cell are in series with the prods. For high-resistance continuity, A.C. or D.C., they are in series with the neon lamp and prods. In the case of D.C. the "B" battery is used. In the case of A.C., it is connected to the tester by the receptacle plug provided. Using D.C. with the neon tube, only the negative element glows, so that gives an indication of polarity.

In making an R.F. search, the diode can be used with either 1 or 2 stages of audio amplification and the audio gain adjusted by the volume control.

In making an A.F. search, either 1 or 2 audio-frequency stages can be used and here again the gain is controlled by the input potentiometer. The radio input (diode) will of course also pick up audio signals (diode to ground).

## HOW TO USE

The principal suggested useful tests are as follows:

### No. 1—Audio Test:

Input prods at IV and III;  
Switch at Position 2 for 1A.F., at Position 1 for 2A.F.;  
Phones at output VI and VII;  
Regulate volume at Gain Control.

### No. 2—Hum Search:

Same as above, but connect prods to a suitable open-core iron inductance.

### No. 3—Radio-Frequency Test (at any R.F. input or output circuit):

Input prods at I and II;  
Switch at Position 2 for diode detector and 1A.F.;  
Switch at Position 1 for diode detector and 2A.F.;  
Phones at output VI and VII.

### No. 4—Interference Locator:

Same as above, but connect a suitable loop antenna and tuning condenser to input terminals I and II.

### No. 5—Voltage Indication:

Prods at VIII and IX;  
Switch at 1 for up to 500 volts, max.;  
Switch at 2 for up to 330 volts, max.;  
Switch at 3 for up to 220 volts, max.;  
Switch at 4 for up to 110 volts, max.;  
(65 to 90 volts min.).

The neon tube draws 1 milliamperere.

**GEOPHYSICAL PROSPECTING OUTFITS**



**BLUE PRINTS and INSTRUCTIONS**

For Building the Following Treasure Finders and Prospecting Outfits

- Folder No. 1. The "Radiofactor Pilot"—consists of a 2-tube transmitter and 8-tube receiver. Principle: radiated wave from transmitter loop is reflected back to receiver loop. Emits visual and aural signals. Tubes used: two 1A6G—two 1N5G—one 1H5G.
- Folder No. 2. The "Harmonic Frequency Locator"—Transmitter radiates low frequency wave to receiver, tuned to one of Harmonics of transmitter. Using regenerative circuit. Emits aural signals. Tubes used: one 1G6G—one 1N5G.
- Folder No. 3. The "Beat-Note Indicator"—Two oscillators so adjusted as to produce beat-note. Emits visual and aural signals. Tubes used: Three type '30.
- Folder No. 4. The "Radio-Balance Surveyor"—a modulated transmitter and very sensitive loop receiver. Principle: Balanced loop. Emits visual and aural signals. By triangulation depth of objects in ground can be established. Tubes used: Seven type '30.
- Folder No. 5. The "Variable Inductance Monitor"—a single tube oscillator Generating fixed modulated signals and receiver employing two stages R.F. amplification. Works on the inductance principle. Emits aural signals. Tubes used: six type '30.
- Folder No. 6. The "Hughes Inductance-Balance Explorer"—a single tube Hartley oscillator transmitter and sensitive 3-tube receiver. Principle: Wheat-stone bridge. Emits aural signals. Tubes used: two type '30—one type '32—one type '33.
- Folder No. 7. The "Radiodyne Prospector"—a completely shielded instrument. Principle: Balanced loop. Transmitter, receiver and batteries enclosed in steel box. Very large field of radiation and depth of penetration. Emits aural signals. Tubes used: two 1N5G—one 1G4G—one 1H5G—one 1Q5—one 1G4.

With any one of the modern geophysical methods described in the Blue-Print patterns, Radio outfits and instruments can be constructed to locate metal and ore deposits (prospecting); finding lost or buried treasures; metal war relics; sea and land mines and "duds"; mineral deposits; subterranean water veins; oil deposits (under certain circumstances); buried gas and water pipes; tools or other metallic objects sunken in water, etc., etc.

Each set of blueprints and instructions enclosed in heavy envelope (9 1/2" x 12 1/2"). Blueprints 22" x 34"; eight-page illustrated 8 1/2" x 11" folder of instructions and construction data... **50¢** Add 5¢ for postage

The complete set of seven folders..... **\$3.00** Shipping weight 2 lbs. (add 25¢ for shipping anywhere in U.S.A.)

**TECHNIFAX**  
RC-840

1917 S. STATE ST. CHICAGO, ILL.

**TECHNIFAX** 1917 So. State, Chicago, Ill.

Enclosed herewith \$..... for which mail to address below:

Treasure Finder No. 1, 2, 3, 4, 5, 6, 7.  
Complete set of seven folders.

NAME .....

ADDRESS .....

CITY ..... STATE .....

RC-840

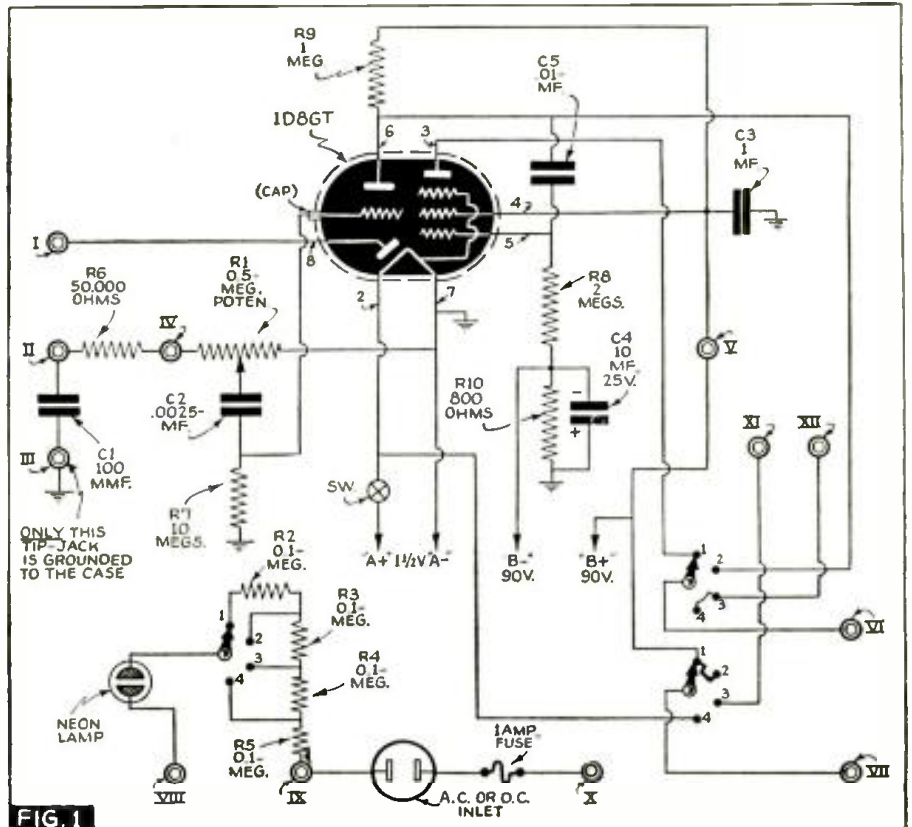

**FIG. 1**

Headphones and test prods complete the Signal Tester—Plus, shown above. The neon tube, in the actual instrument, is protected by a transparent cover.

- No. 6—Line Polarity: Same as above, negative neon electrode glows.
- No. 7—A.C. Continuity Neon Test (for indication of condenser capacity, test or open condenser, etc.): Prods at VIII and X; Connect 110 volts A.C. to plug receptacle; Switch on Position 4.
- No. 8—D.C. Continuity Test (for condenser dielectric strength, condenser leakage, etc.): Prods at III and VIII; Connect jumper from V to IX; Switch on Position 4.
- No. 9—Direct Phone Prods (for audio test, phono pickup output, microphone transformer output, etc.): Phones at VI and VII; Switch at Position 3; Prods at XI and XII.
- No. 10—Low-Resistance Continuity: Switch at Position 4; Prods at III and XII; Phones at VI and VII.
- No. 11—Lead-in, Transmission Line or Aerial Test: Connect aerial input to primary of R.F. transformer. Connect secondary of the R.F. transform-

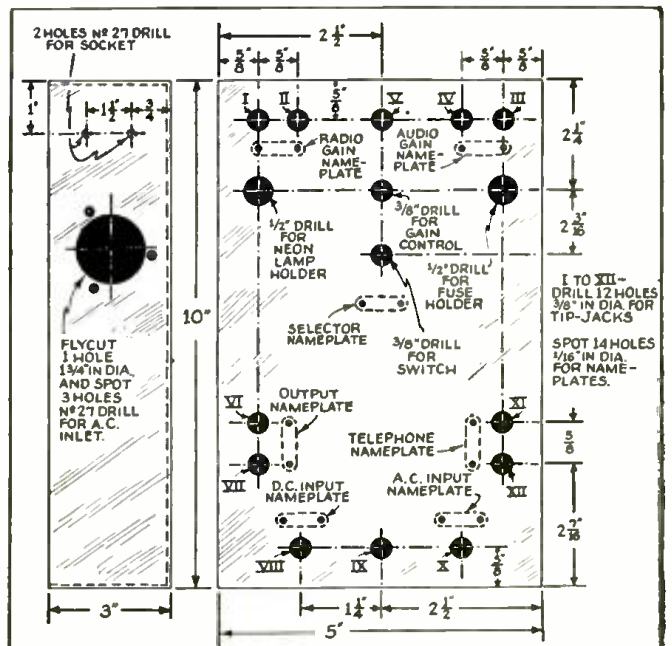

**Fig. 2. Cabinet details.** Tip-jack colors preferred by the author are: I, red; II, black; III, purple; IV, dark green; V, slate; VI, light green; VII, brown; VIII, slate; IX, dark brown; X, brown; XI, XII, green.



er to R.F. input I and II, with a parallel tuning condenser if necessary.  
Other connections same as No. 2.  
**No. 12—Test for Line Power Supply:**  
Prods at VIII and IX to power outlet; Switch at Positions 1 to 4;  
Note neon indication.

**LIST OF PARTS**

**CASE**  
One Parmetal case No. B-4508, and bottom plate No. BP-4508, black wrinkle finish, size 10 x 5 x 3 ins. deep.  
**RESISTORS**  
One Mallory type N, 1/2-megohm potentiometer and switch;  
Four IRC, 0.1-meg., 1/2-W., type BT 1/2, R2, R3, R4, R5;  
One I.R.C., 50,000 ohms, type BT 1/2, R6;  
One I.R.C., 10 meg., 1/2-W., type BT 1/2, R7;  
One I.R.C., 2 meg., 1/2-W., type BT 1/2, R8;  
One I.R.C., 1 meg., 1/2-W., type BT 1/2, R9;  
One I.R.C., 800 ohms, 1/2-W., type BT 1/2, R10.  
**CONDENSERS**  
One Mallory, 100 mmf. mica, C1;  
One Mallory, 250 mmf., mica, C2;  
One Mallory, 1 mf., 400-V. paper, C3;  
One Mallory, 10 mf., 25 V. electrolytic, C4;  
One Mallory, 0.01-mf., 400 V. paper, C5.  
**MISCELLANEOUS**  
One National Union type 1D8GT.  
One Mallory 3-circuit 4-position switch No. 3234J, with plate and knob;

Twelve Mallory 400 Series tip-jacks, colors as desired;  
Four Mallory No. 15 tip-plugs;  
Two ICA No. 355 test prods;  
One General 1 1/2-volt "A" cell No. 2F1;  
Two General 51-volt "B" batteries No. V-34-AAA;  
1 Pair Cannonball "Master" headphones;  
One Littelfuse No. 1075 fuse extractor post and 1-ampere fuse;  
One Littelfuse No. 5123 neon holder;  
One Littelfuse No. 5122 neon tube, 1/20 watt;  
One Amphenol 61M10 male receptacle, flush mounting;  
Seven Crowe nameplates, one each No. 16, A9, I15, G15, J11, D9 and A2;  
One triple insulating tie lug;  
Two hollow spacers, 3/16-in. in dia. x 1 1/2 ins. long (for socket);  
Two No. 6-32 round-head brass screws 1 3/4 ins. long;  
One Amphenol octal socket No. MIP8;  
One grid clip;  
Ten feet Push-back hook-up wire;  
Six feet No. 18 flexible rubber-covered wire;  
One double and 2 triple connector plugs for batteries;  
Four No. 6-32 round-head brass screws, 1/2-in. long;  
Six No. 6-32 hex. brass nuts, lock washers and soldering lugs;  
One-quarter lb. rosin-core solder.

**BOOK REVIEWS**

**TELEVISION**, by V. K. Zworykin and G. A. Morton (1940). Published by John Wiley & Sons, Inc. Size, 6 x 9 ins., cloth cover, profusely illustrated, 646 pgs. Price, \$6.00.

V. K. Zworykin, E.E., Ph.D., Electronics Research Laboratory, RCA Manufacturing Co., and G. A. Morton, Ph.D., same division, same company, have collaborated to produce the most up-to-date book on electronic television.

"Television—The Electronics of Image Transmission" considers in Part I the fundamental physical phenomena involved in electronic television. Part II deals broadly with the field of television. Part III is an analysis of the components of the electronic television system. Part IV describes the entire television system exemplified in RCA/N.B.C. television operations.

Chapter headings give only a suggestion of the wealth of detail and ample illustrations in the many subjects treated.

No person interested in television can afford to be without this timely book.

Part I—Fundamental Physical Principles—Emission of Electrons from Solids; Fluorescent Materials; Electron Optics; Vacuum Practice. Part II—Principles of Television—The Fundamentals of Picture Transmission; The Transmission and Reproduction of High-Definition Pictures; Video Pick-up Devices; Picture Reproducing Systems. Part III—Component Elements of an Electronic Television System—The Iconoscope; The Kinescope; The Electron Gun; Video Amplifiers; Scanning and Synchronization; The Television Transmitter; The Receiver. Part IV—RCA/N.B.C. Television Project—RCA Television Project—Studio and Monitoring Equipment; Empire State Transmitter; Conclusion.

**RADIO ANNUAL 1940**, Compiled by the Staff of *Radio Daily*. Published by *The Radio Daily*. Size, 6 1/2 x 9 1/2 ins., cloth cover, 988 pgs. Free with 1-yr. subscription to *Radio Daily*.

It is evident from a review of the third or 1940 Edition of the "Radio Annual" issued to *Radio Daily* subscribers, that lessons have been learned from the experiences of the preceding issues. The march of radio during 1939 is succinctly portrayed, and the prospects for 1940 are analyzed, by a group of specialists.

James Lawrence Fly, Chairman, Federal Communications Commission, discusses radio from the social standpoint; Neville Miller, Pres., National Assoc. of Broadcasters, describes the broadcasting kaleidoscope of events; David Sarnoff, Pres., RCA, presents facts and figures; Elmer Davis, C.B.S. news analyst, analyzes his field of operations; education is covered by William Dow Boutwell, U. S. Office of Education; Margaret

Cuthbert, N.B.C., writes on "The Women"; foreign affairs is John H. Payne's (U. S. Department of Commerce) topic; Orson Welles' topic is "Radio Drama". Frequency modulation, short waves, facsimile, the New York World's Fairs of 1939 and 1940, television, and air schools are other subjects briefly analyzed.

Another chapter is "Radio History Makers of 1939" with thumbnail illustrations and writeups; operations and decisions of the Federal Communications Commission are reviewed.

Room does not permit further analysis of the innumerable topics touched upon in this nearly 1,000-pg. book. It may be pointed out however that, as with preceding issues of the Annual, there are included an up-to-date listing of the broadcast stations of the United States; publications covering the field of radio; advertising agencies and radio station representatives; and a number of other groupings of lesser extent, but in proportion of perhaps equal importance.

Television and facsimile have a 26-pg. section all to themselves.

**FLUORESCENCE AND PHOSPHORESCENCE**, by E. Hirschclaff (1938). Published by Chemical Publishing Co., Inc. Size, 4 x 6 3/4 ins., cloth cover, 41 illustrations, 130 pgs. Price, \$1.50.

We do not know what particular significance, if any, may attach to the statement that this is a "First American Edition—1939" but you now have the quote for whatever it is worth.

Essentially this book is a "monograph" and is of little interest to any but tube specialists, more particularly those interested in photoelectric and television phenomena; to these, this book will be an invaluable reference to the most up-to-date information on how and why a vapor or a liquid irradiated by light may be able to emit light (fluorescence), and why this re-emission may continue after the existing radiation has been cut off (phosphorescence). Chemical formulas and mathematical equations are included to clarify such subjects as the fluorescence of atoms and molecules, the quenching of fluorescence, cathodoluminescence in gases, liquids and solids; etc.

**THE METEOROLOGICAL GLOSSARY**, (3rd Edition, 1940). Published by Chemical Publishing Co., Inc. Size, 6 x 9 ins., cloth cover, illustrated, 251 pgs. Price, \$3.00.

The 3rd Edition of this book will be of interest to those technicians whose business it may be to acquire familiarity with the underlying causes of the changes in weather conditions. This group would include amateurs interested in learning the whys and wherefores of shortwave performance; and, broadcast technicians.

(See Pages 100 and 128 for other book reviews)

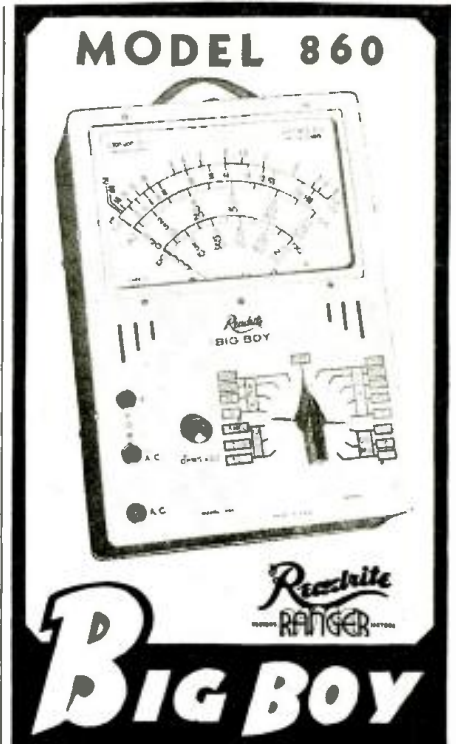

- BIG IN VALUE
- BIG IN PERFORMANCE
- SENSATIONALLY PRICED AT \$17.85

Here is an AC-DC Volt-Ohm-Milliammeter with all the ranges you want . . . easily readable on the large 7" instrument with extra-long 6" scale . . . in a new up-to-date three-tone case you will be proud to use in your panel, bench or on calls to the home. Check Readrite Big Boy's adaptability for your requirements: DC V. 0-10-50-250-500-1000 at 1000 ohms per volt; AC V. 0-10-50-250-1000 at 400 ohms per volt; DC Ma, 0-1-10-100; Resistance ranges: 0-500 ohms shunt type circuit and 0-100,000 ohms. 1.5 megohms and higher by additional batteries. Maroon case with cream panel, attached handle . . . Dealer Net Price . . . \$17.85



**MODEL 432 - A TUBE TESTER**

The Outstanding Tube Tester Value . . . Checks all types including Locals, Single Ends, Bantam Jr., and the 1.4-volt Miniatures, Gaseous Rectifier, Ballast, High Voltage Series, etc. Filament Voltages from 1.1 to 110 volts. Direct Reading GOOD-BAD Meter Scale. Counter or Portable Case with roomy compartment for tools, etc., \$18.85 Dealer Net. In case less \$17.85 compartment . . .



WRITE FOR CATALOG  
Section 816 College Avenue

**READRITE METER WORKS, Bluffton, Ohio**

# IMPROVED REFLEX SPEAKER

This article explains the advantages achieved by applying the principle of sound reflection to an exponential horn driven by a horn unit.

R. C. REINHARDT

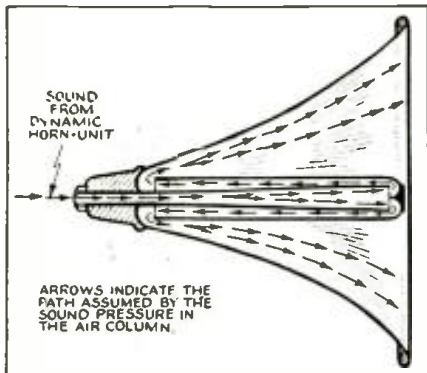

At top.—"Morning Glory" reflex projector makes available in an over-all length of 25 ins. an effective 6-ft. air column; frequency cut-off, 90 cycles. With a bell opening of 29 ins. the projection angle is 100°. Note the weatherproof housing for the P.M. dynamic motor unit.

Below.—This cross-section illustration of the reflex projector shows how the long air column is achieved in a short horn.

**A** NEW line of sound projectors, characterized by a foreshortened horn driven by a horn unit, achieves increased transducing efficiency, good voice reproduction, and high-intensity projection, in addition to having the mechanical advantages of compactness, simplicity of mounting, and 100% storm-proof protection. How these desirable qualities have been obtained is information of interest to many sound men.

The "Morning Glory," as the new construction has been named, is an adaptation of the so-called "marine-type reflexed trumpet," driven by a horn-type unit, which has been used for warship and merchant

marine service for the past 5 years. By combining this general construction (but with improvements which will be described) with certain desirable features of a second class of loudspeakers generally referred-to in the sound field as the "WX-type marine horn," driven by a cone-type unit, the attributes mentioned in the first paragraph of this article are obtained.

Although the resultant loudspeaker construction is ideally suited to the rigorous demands of continuous outdoor service under any weather and atmospheric conditions, it is readily adaptable to the requirements of indoor use, as sound men will perceive.

## IMPROVED REFLEX SPEAKER

All acoustic transducer systems having to do with the reproduction of sound fall into 2 broad classifications. The most popular of these is the paper-cone dynamic speaker mounted in a baffle or housing. (See Fig. A.)

It will be generally agreed that the popularity of this assembly is due to the low initial cost and small physical dimensions of the equipment together with proper mounting facilities. However, the attendant low acoustic transfer efficiency (that is, comparatively low audio output power for a given electrical input power), and poor articulation, preclude the use of paper-cone speakers on a system in which the transmission of intelligence (voice) is of paramount importance.

It is this problem of selecting loudspeakers, for application in a system where it is considered better engineering to install apparatus that will most efficiently transmit intelligence under the required operating conditions, that is being primarily considered in this article.

## PROJECTORS FOR HIGH OUTPUT

To design a loudspeaker for high output it is almost imperative to use a horn (or "projector" as it is called). The inherent low efficiency of the flat-baffle type, if it

were used, would impose at least 2 very serious objections.

First, the source of audio supply for the flat-baffle type would necessarily be greater than that required for the horn type for equivalent acoustic output. This would also indicate (a point which naturally follows) that higher-powered—and necessarily more costly—amplifiers are necessary.

Second, and of great consequence, the degree of heat produced in the voice coil for a pre-set output requirement would naturally be higher in the low-efficiency speaker. The degree of heat production in the voice coil is one of the most tenacious problems which confronts the designer of a high-power speaker. For a given size of voice coil, the temperature rise is directly proportional to the power input, and a precarious limit is reached at relatively low power (watts) for conventional speakers.

## EXPONENTIAL HORNS

It was originally believed that a horn merely confined the sound pattern within a limited angle with a corresponding increase of intensity in this region. Conical-shaped horns were widely used in the past to increase radiation from loudspeakers.

Functionally, however, this was most unsatisfactory, inasmuch as a conical horn does not take into consideration the fact that air in motion assumes sharply-defined characteristics. More recently it was found that the true function of a horn is to increase the load on the vibratory system. For a given throat area, the impedance of the horn depends on its shape, and it has been found that the exponential rate of expansion creates a greater degree of linear loading than any other type. (See curve A.)

The formulas which show this to be a fact are quite involved, but if any *Radio-Craft* readers wish to delve deeper into the subject, an excellent reference is available.\*\* However it is generally sufficient merely to keep in mind the importance of

\*\*"Applied Acoustics," by Olson and Massa, P. Blakiston's Son & Co., Inc.

\*See *Radio-Craft*, June 1933.

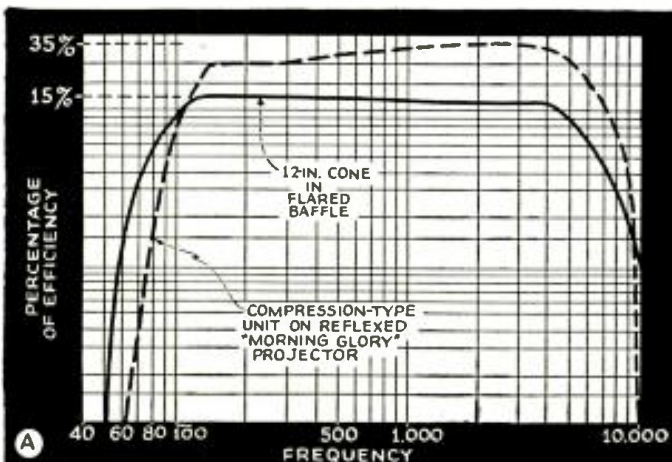

Relative conversion factor of cone speaker in flared baffle vs. compression unit on exponential cavity. A considerable increase in effective output is seen to result with an exponential increase of diaphragm loading.

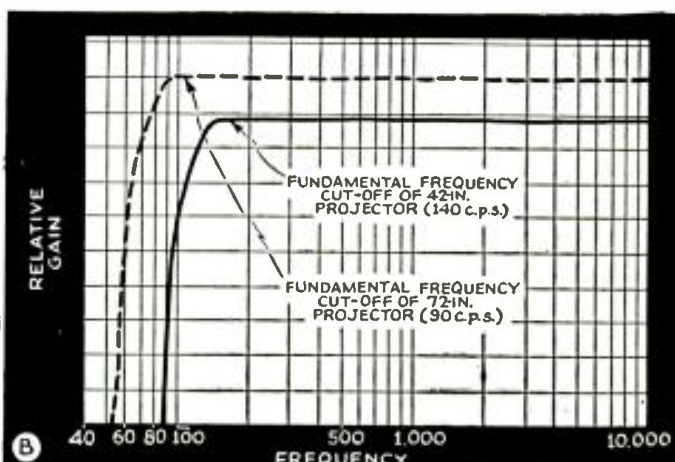

Theoretical response curve. This curve illustrates the fact that the sound projection of an exponential horn may be considered uniform over the frequency range for uniform input from the driving unit, up to cut-off.



having a horn, the rate of expansion of which is an exponent, in contrast with horn types which frequently are loosely referred to as being "exponential" but which in truth are merely patterned to some conical degree of flare.

Referring to curve B, note how the exponential horn maintains uniform loading right out to the cut-off point; and that the longer air-path of the larger horn exhibits somewhat greater efficiency. Do not confuse this theoretical curve of horn performance with the overall frequency response. The latter is almost entirely a function of the motor unit (an item which may be discussed in a later article).

#### REFLEX HORNS

In view of the advantages to be gained in the use of exponential horns coupled to compression-type (or, as they are more generally called, horn-type) speaker units, the concentrically-folded, or "re-entrant" horn herein illustrated, was developed, and because of its flower-like shape, was appropriately named the "Morning Glory" horn.

These have been made available to replace the straight (long) exponential horns which, by comparison with paper cone speakers, are proving too unwieldy and of too great size for efficient handling and mounting.

#### SOUND COVERAGE

Adverse, or cross-wind conditions, which normally disperse low-intensity sound projection, have little effect on the sound beam emitted by these high-velocity output projectors. The sound beam, upon being directed to the area requiring coverage, will produce a "Splash Effect" and thereby cover large areas with uniform-intensity sound.

The directional characteristics and total absence of rear sound generation minimize feedback or acoustic "howl." The flatter frequency response is also of great importance in eliminating feedback at certain peaked frequencies.

#### PHYSICAL DETAILS

The "Morning Glory" projector here illustrated, in addition to its electrical and acoustical advantages mentioned above, presents certain mechanical features that are worth consideration. The entire construction is of metal, and all details are so proportioned that it can be subjected to severe strain and stress without any appreciable damage.

The mounting details are fabricated from malleable iron castings and have unlimited fatigue resistance. The horn proper is built up of a progressive series of non-resonant aluminum spinings, of heavy gauge, adequately protected against the elements with a 2-tone battleship gray enamel. All other details, such as the malleable-iron mounting yoke and trunnions, and the hardware, are electroplated with a zinc-cadmium alloy to resist oxidation and ultimate deterioration.

Unlike its prototype, the marine-type reflexed trumpet, which used an electrodynamic motor unit, the Morning Glory utilizes the more modern, permanent-magnet dynamic motor, thus eliminating field pot wiring. This unit is shown, in the photo, encased in a weatherproof, streamline housing.

Contrary to popular belief, the concentrically-folded re-entrant horn will perform

This term, inasmuch as it is introduced here for the first time, requires a little explanation. Briefly, it may be likened to the effect which results when a stream of water is directed at high intensity against a solid surface. Just as in the water analogy, when a high-intensity sound beam strikes a given area, as for instance a crowd at a stadium, it has been found to "mushroom," or "splash," to a much greater extent than is the case when a low-intensity sound beam reaches its objective. In fact, in the latter instance, the sound may be entirely absorbed, allowing none of the sound energy to disperse even within a limited area.

IT'S RCA FOR UNMATCHED QUALITY...UNBEATABLE LOW PRICES!

# RCA AERODYNAMIC "MIKE"



*Priced right for even the lowest cost job!*

← RCA Aerodynamic Microphone...MI-6226D (low impedance) MI-6228B (high impedance).



RCA Junior Velocity Microphone MI-4036G.



RCA Uni-Directional Microphone MI-4043, RCA 3-Way Microphone MI-4044.



RCA Pressure Microphone MI-4048A.



RCA Velocity Microphone MI-4027B.

THE RCA Aerodynamic Microphone is typical of the world's most complete line of "mikes"! It's tops in quality, low in cost. Has proved its value through splendid performance under the most difficult conditions. In the air, on the ground—even in a diver's helmet under water, the quality is outstanding.

No matter what kind of installation you make you have satisfied customers when you use RCA microphones. Pressure, velocity, lapel, uni-directional, bi-directional, non-directional—all types are available, for use outdoors or in. And remember—the prices are right.



## Commercial Sound

RCA Mfg. Co., Inc., Camden, N. J. • A Service of Radio Corporation of America

Any sound system sounds better, equipped with RCA Radio Tubes

### FILMGRAPH VOICE AND MUSIC RECORDINGS

PERFECT SOUND on film recording can now be had with FILMGRAPH at only 25¢ per hour (this is cost of film only—no other expense). Permanent play-back. The only device capable of making lengthy recordings and play-back. Closing out several demonstrator models at special price. Complete 1940 line now ready at special price. MILES REPRODUCER CO., INC., Dept. RC, 812 Broadway New York City

See Page 120 for Important Announcement on Radio Service Manuals

### NEW AUDIOGRAPH Sound Catalog

AUDIOGRAPH Sound Systems represent the latest in Sound Engineering and Design—a complete line plus pre-tested accessories.

### NEW LOWER PRICES

Outstanding quality and performance at prices that help you meet any competition.

WRITE FOR FREE COPY

JOHN MECK INDUSTRIES  
1313 W. Randolph St., Chicago, Ill.

quite as well as a straight or full-length exponential trumpet; requires a fraction of mounting space; and the construction obviates the possibility of water or any other foreign matter reaching the throat.

The Morning Glory projectors have a universal application—indoors, outdoors, and sound truck. The reflexed construction results in a considerable reduction in overall length.

This article has been prepared from data supplied by courtesy of Atlas Sound Corp.

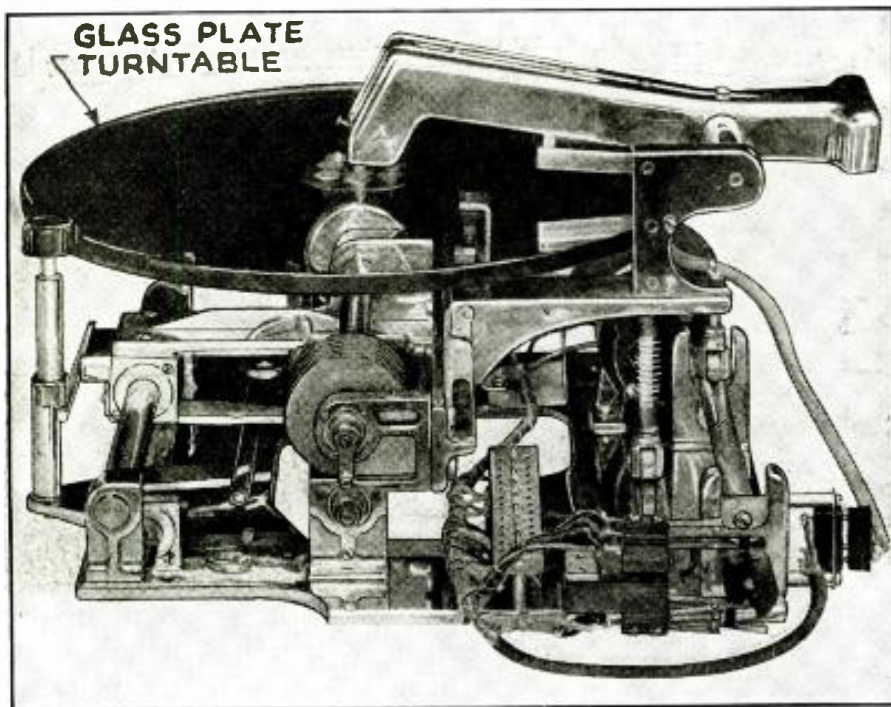

A well-known sound specialist describes a method of recording and playback of sound-on-disc said to be new in principle and revolutionary in the industry. The result of 4 years' laboratory work, it permits recording a ½-hour of music (present recording time, 4½ mins.) and 45 mins. of speech (vs. 8 mins. by conventional methods), by embossing on thermo-plastics.

← Fig. 1. The commercial recorder at left was developed by Recordall Mfg. Company for recording and playback of constant groove-speed discs. The same "cutting" head and needle are used for playback of the embossing.

## CONSTANT GROOVE-SPEED RECORDING

*On Thermo-Plastics — Using the Embossing Process*

E. E. GRIFFIN

**E**NTIRELY new in principle and revolutionary in the industry, Constant Groove-Speed Recording is one of the most outstanding improvements in disc recording since 1926, when Maxfield and Harrison published the results of their work on the art of disc recording.

This new method in combination with the embossing process rather than the cutting, in addition to giving the highest fidelity possible, results in the most economical method yet developed since it makes possible the recording of a full ½-hour of music on one side of a standard-size record—as against 4½ minutes on the conventional phonograph disc—or 45 minutes of speech as compared to 8 minutes on the present conventional dictating machine.

### FIXED LINEAR SPEED

Constant groove-speed, as the words imply, means that the linear speed of the recording track in inches per second is fixed, independently of the record diameter.

In the conventional phonograph a fixed angular velocity of 78 or 33 1/3 r.p.m. is used, and this results in an excessive groove-speed at the outside and a too-slow groove-speed at the inside of the record. Taking a 12-in. diameter disc, the groove-speed at 78 r.p.m. will change continuously from 48 to 12 ins. per second as the stylus moves from the largest to the smallest diameter. The same size disc will give a variation of groove-speeds approximately from 21 to 5 ins. per second at 33 1/3 r.p.m.

It is at once obvious that it is not possible to have the same quality of recording for all of these different speeds—without continuously-variable compensation and equalization, in addition to correction for varying amounts of distortion. The excessive linear velocity near the outside of the disc reaches a point where the heat created

through friction puts excessive wear on the recording stylus and playback needle.

At constant groove-speed an optimum linear velocity can be selected for the required frequency response in each case, and this linear velocity being constant, all equalization can be predetermined and permanently built into the amplifier. No variable equalization or compensation is required. The quality, volume level and distortion percentage remain fixed in quantity, regardless of the momentary diameter of the record at any recording position.

This feature of the constant groove-speed makes the use of the embossing process practical, since excessive high-frequency attenuation—caused by the damping effect of the record material's resistance to burnishing—can be equalized by proper tilting of the amplifier's frequency response curve—for a uniform linear velocity.

The building-up of high-frequency response, on the other hand, is made possible by qualities inherent in the embossing process (outlined subsequently) without bringing surface noise to an objectionable level.

Also, since the embossing process causes practically no wear on the polished round point of the embossing stylus, its life is practically limitless, a decidedly economical advantage over sharp-edged styli as used in the cutting method.

### EQUIPMENT

Figure 1 illustrates how constant groove-speed is accomplished in Recordall equipment. The relative position of cutting head, recording stylus and the patented drive wheel is visible through the plate-glass turntable.

This drive-wheel and shaft are integrally mounted with the head carriage mechanism, so that the relative position of the record-

ing stylus and drive wheel remains the same, regardless of the momentary position of the head on the record. The rotating of the drive wheel by a synchronous motor explains how constant groove-speed is obtained.

A drive shaft speed of 90 r.p.m. has been arbitrarily chosen for high-fidelity recording and is used on Recordall models where high-fidelity recording of the wide range of the audible spectrum of voice and music is desired. Slower drive shaft speeds are used on the business and conference models, where their use requires the intelligibility and recognizability of the speaker only, while still slower speeds are used on the communication models where intelligibility only is required. Figures 2 and 3 show the time available on different-size discs for recording on the various models.

### EMBOSSING

Embossing or burnishing was used almost exclusively in recording on aluminum blanks—the first and comparatively recent, yet already outmoded, form of "instantaneous" recording. The crystalline structure of all aluminum alloys used made this imperative—since cutting exposed such granularity in the material that the increased surface noise created an entirely unsatisfactory signal-to-noise ratio. The embossing process on aluminum, on the other hand, required very much greater power, since the cutting head had to be weighted and the cutting armature damped, "stiffened," to overcome the resilience of the metal and its high resistance to burnishing.

All these requirements added up in creating all kinds of frequency distortion and the resultant distortion being a function of the momentary linear groove speed, equalization was extremely difficult. A well-trained, experienced recording engineer



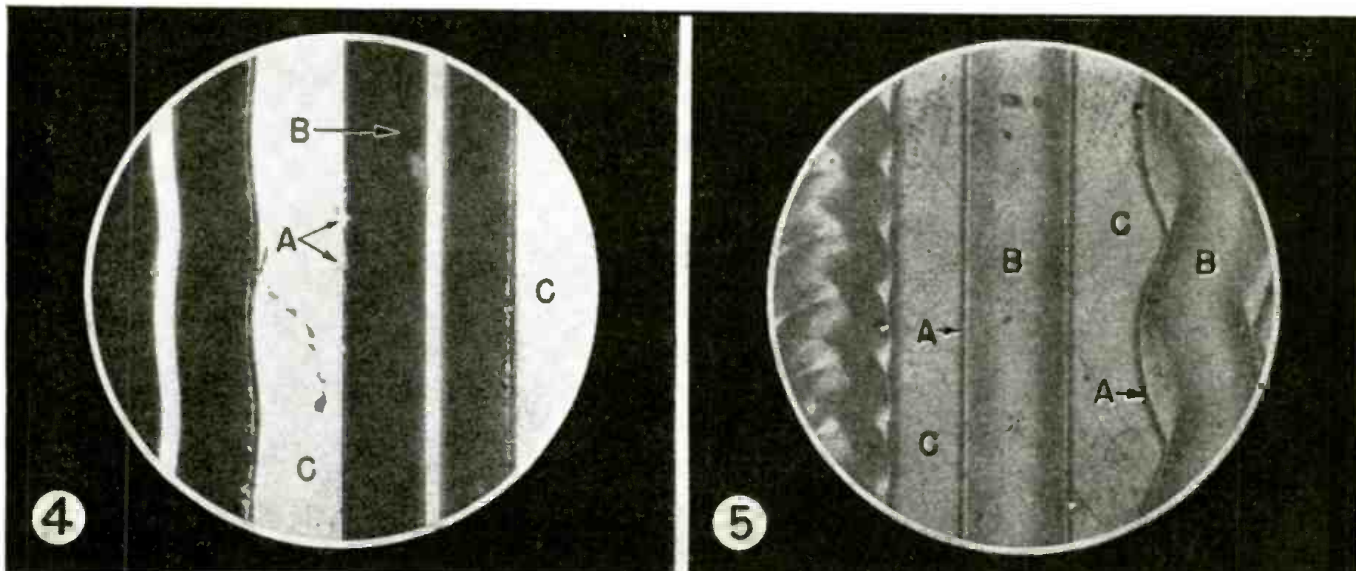

Figs. 4 and 5. Unretouched microphotographs of recording on thermo-plastics; Fig. 4, cutting creates a source of high noise level; Fig. 5, embossing offers a high signal-to-noise ratio.

could produce satisfactory results on carefully-designed equipment—but even the best records were comparatively short-lived, deteriorated with age and had to be played with special equipment, and non-metallic needles to maintain their quality, even during this short life. Thus embossing on aluminum has gradually gone into the discard and with it, apparently, its outstanding one good feature, either overlooked or purposely disregarded by recording engineers, but retained by the present method of embossing on thermo-plastics.

**THERMO-PLASTICS**

The introduction of "acetate" coating on aluminum recording discs caused the return to cutting instead of embossing—since cutting was at the time a much better developed art and without any doubt had quite a few advantages. It didn't require excessive weight on the cutting head or too much equalization—at average speeds—and could well be played back with most any kind of pickup and most any kind of needle.

The fine-grained structure of most nitrates used to make these "acetate discs" reduced surface noise to a satisfactory minimum and with a little training even the uninitiated layman could learn to produce records comparable in many respects to commercial pressings. These facts account for the increasing popularity of instantaneous recorders.

The fact that acetate records are much

more stable to temperature changes than wax, and so eliminate the necessity of temperature-controlled storage and recording, in combination with simplified mechanical construction and the instantaneous playback feature makes their use in professional recording advantageous.

Constant groove-speed — as mentioned above—made the return to embossing possible. Several features of this process in combination with acetates and other plastics make it desirable.

The atomic structure of these materials shows a combination of hydrocarbons and crystalline substances, and the "floating" process used in the manufacture of records, brings the finest grain to the surface. The coating and hardening of the substance creates a surface tension. The combined result is a shiny "skin," the thickness of which is a function of (a) the chemical structure, (b) the thickness of the entire coating, and (c) the speed employed in the drying process. Considering the fact that total thickness of coating seldom exceeds 0.0065-in. (for cutting), it is easy to see that the skin can be measured in microns only.

**"SCRATCH"**

Cutting disturbs the continuity of the skin, unbalancing the surface-tension. The microphotograph, Fig. 4\*, clearly shows at "A" the resulting "tear," ragged edges on

the unmodulated groove. At the same time comparatively larger grains are exposed, as is plainly visible if the dull structure of the sidewalls, "B," is compared with the shiny, undisturbed land, "C," between grooves. It should be apparent that faithful reproduction of this groove will result in some surface noise ("scratch").

Let us now examine the microphotograph of an embossed section of the same record, Fig. 5. (The photographs, by the way, were taken under identical conditions with the same magnification and are unretouched.) The cut was recorded on a standard professional recorder with a new sapphire stylus by a competent recording engineer and the embossing on a standard Recordall machine. Note that the "skin" was not disturbed on the embossed record. Edges, "A," of the unmodulated groove show absolutely no tear, no raggedness, and the structure of the sidewalls and the bottom of the grooves, "B," is just as smooth and shiny as the undisturbed land, "C," between grooves. Approximately 100 diam. enlargement does not show any source of surface noise here.

Analyzing the embossing process it was found that the triple action of burnishing results in the best groove obtainable—if used in combination with constant groove-speed. A blunt stylus under great pressure (between 75,000 and 125,000 lbs. per sq. in.) compresses the recording substance, the heat created by friction followed by rapid

\*Courtesy: Dr. Gordon Laboratories, Hollywood, Calif.

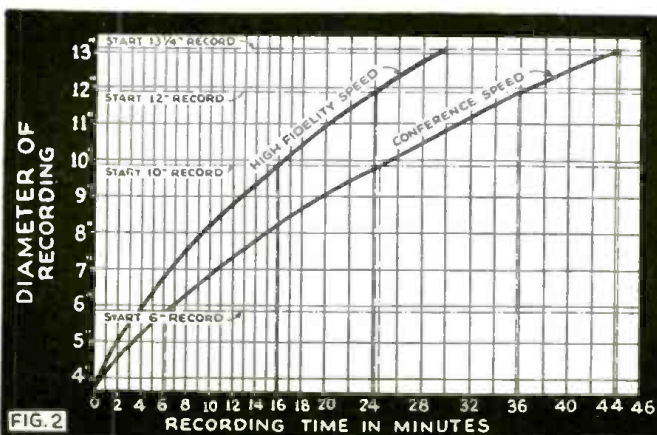

Fig. 2, playing time for discs recorded at constant groove-speed. High-fidelity speed at 10 ins. per second; conference speed, 7½ ins. per second. Fig. 3, playing time at rate of 5 ins. per second, as used on communication models.

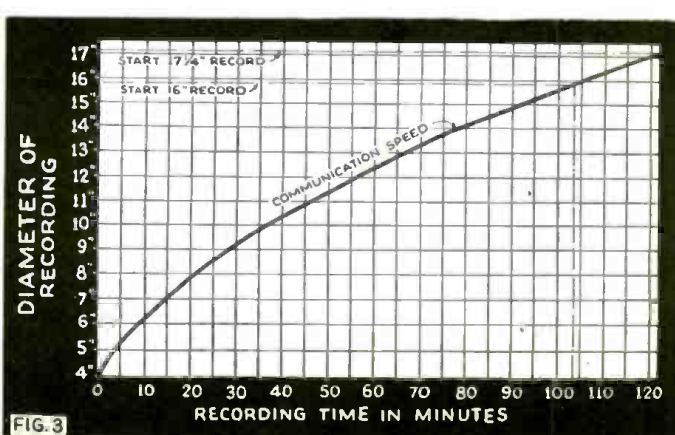

Fig. 3, playing time at rate of 5 ins. per second, as used on communication models.

•SOUND•

# DIRECT - COUPLED AMPLIFIERS



## "The Ultimate in Design"

These new 10, 20 and 30 Watt Direct-Coupled (Push-Pull Loftin-White) Amplifiers are now available with any one or more of 14 optional features, including Variable Speed Non-Overloading Push-Pull Expander, High Frequency Accentuation and Attenuation, Low Frequency Boost and Cut Control, Push-Pull Automatic Volume Compressor, Push-Pull Automatic Volume Limiter, Push-Pull Automatic Volume Control, Non-Frequency Discriminating Scratch Suppressor, Low-Gain Single Ended Input, High-Gain Single Ended Input, Low-Gain Push-Pull Input, High-Gain Push-Pull Input, Audio Spectrum Control, Calibrated Volume Indicator, and Push-Pull Remote Control.

Write or Wire Today for Complete Details and Unusually Attractive Prices.

**AMPLIFIER CO. of AMERICA**

17 WEST 20th STREET NEW YORK, N. Y.



**A TRIAL WILL PROVE  
you  
it pays to use  
WRIGHT VERIFIED SPEAKERS**

Catalogue mailed on request

New York: No. 17 West 60th Street  
Los Angeles: 1101 W. Olympic Blvd.

**WRIGHT, Inc.**  
St. Paul, Minn.

cooling—uniform at constant groove-speed—hardens the groove by "heat-treatment"—while the blunt, smooth nose of the stylus polishes the recorded surface by burnishing. The result is a hardened, durable and smooth groove with an excellent signal-to-noise ratio.

### FIDELITY

Examining the frequency-distortion characteristics of the same 2 kinds of recording, the cutting process has an undisputed superiority—in recording. A sharper stylus under less weight, with less damping can more faithfully follow high-frequency modulation. But the necessity of using a different-shaped playback needle point and equalization necessitated by the inherent surface noise features of the cut groove, practically eliminate these advantages.

The fundamental defect existing in all disc recording systems where a sharp-edged, chisel-shaped cutting tool is used to form the groove, and a round-nosed needle is used in playback, is the fact that these 2 shapes are entirely different. The groove so cut will couple to the round-point playback needle so long as the groove is unmodulated; as soon as modulation takes place, the cut groove becomes narrower as it deviates from a straight line, resulting in improper coupling to the playback needle in reproduction.

This condition is overcome in the embossing method since the recording stylus is used in playback exactly the same as it is in recording, thus resulting in the best possible coupling and resultant minimum distortion. What good does a "high-fidelity" recording do if the higher frequencies have

to be eliminated to correct the signal-to-noise ratio in playback?

The damping effect of the plastic on the embossing stylus attenuates the high frequencies—as we pointed out above. The constant groove-speed on the other hand makes permanent predetermined equalization for this diminished high-frequency response possible and the absence of inherent noise in the embossed groove makes this equalization practical with very little effect on the signal-to-noise ratio. Boosting the high frequencies as much as 30 db. at 7,000 cycles was found to be quite permissible, the noise level of the resultant record, when played-back without equalization being still lower than that of any cut record.

### RECORDING-PLAYBACK STYLUS

The fact that constant groove-speed embossed records can be played back with the same stylus they were recorded with, at the same angle, makes it possible to reproduce all there is on the record. Another glance at the microphotographs (Figs. 4 and 5) will show at "D" that the groove-width remains constant in the modulated track on the embossed record, but undergoes substantial variations in the cut record.

This is caused by the chisel-point shape of the cutting stylus in combination with the pivoting of the armature as usually employed, causing a vertical shift of the momentary periphery of the point doing the actual cutting. The blunt nose of the playback needle will have a noticeable up and down motion as it is squeezed out of the groove where it contracts—adding to the distortion as it increases the danger of jumping grooves. This necessitates a deeper groove in the cut than in embossing.

Thus more lines per inch can be used with the embossing system without endangering the tracking of the playback needle in the groove—while the reduced depth also reduces the required thickness of the recording substance on the metallic backing.

All these factors tremendously increase the economy of this system in addition to appreciably improving the quality of reproduction and simplify the process to enable the operation of such equipment by laymen—and we think it justifies the contention that it is the most outstanding improvement in disc recording since 1926.

*This article has been prepared from data supplied by courtesy of Recordall Mfg. Co., Inc.*

## BOOK REVIEWS

**DICTIONARY OF TECHNICAL TERMS.** by Frederic S. Crispin (3rd Edition, 1940). Published by The Bruce Publishing Co. Size, 6 x 8 ins., cloth cover, illustrated, 327 pgs. Price, \$2.25.

The revised and enlarged edition of "Dictionary of Technical Terms" is an exceptionally comprehensive compilation, taking in as it does the nomenclature of about 70 fields.

The book features more than 1,000 new words, various tables of weights and measures, and many new illustrations. Included in the classifications are radio, electricity, physics, science, ceramics and the plastic art. The dictionary is for the use of students, draftsmen, mechanics, builders, electricians and workmen generally. The author has made the scope broad rather than detailed and hence has not included all the technical terms in any field of endeavor.

**HOW TO USE THE CATHODE-RAY TUBE,** by J. H. Reyner (1940). Published by Furzehill Laboratories, England. Size, 5 x 7½ ins., paper cover, 33 illustrations, 40 pgs. Price, 1 shilling (about 35c, including postage).

This booklet may be considered a primer on cathode-ray tube operation for technicians who are otherwise "up" on their radio theory.

**DO YOU WANT TO GET INTO RADIO?** by Frank A. Arnold (1940). Published by Frederick A. Stokes Co. Size, 5 x 8 ins., cloth cover, 140 pgs. Price, \$1.50.

For each type of radio work, the author states definitely what temperament, education and experience is required of the applicant and what kind of work and surroundings the beginner may expect to encounter, to get into the respective fields of radio.

A chapter is devoted to personal aptitudes for radio work in general, and whether college training is essential. An appendix lists those colleges which regularly give courses in radio.

States the author in his preface: "I am writing this volume for the hundreds of young men and women who would like to get into radio but do not know how to go about it. It is intended not as a textbook or a study in psychology; rather as the story of radio broadcasting from the standpoint of its career possibilities, bearing always in mind the training and aptitudes required for success in this field." This non-technical book analyzes business possibilities in broadcasting and television.

(Turn to Pages 95 and 128 for other Book Reviews.)

**FREE CATALOG**



**ALL RADIO NEEDS**

Here in this one big book you will find everything you need in radio ... sets, parts and supplies ... public address systems ... amateur equipment ... testers and kits ... your nationally known favorites at lowest possible prices. Write today for this big valuable catalog and save money.

**PROMPT SERVICE**

**BURSTEIN-APPLEBEE COMPANY**

1012-14 McGEE STREET, KANSAS CITY, MISSOURI

**RADIO DIAGRAMS**

Any circuit diagram for all radio sets. To help you service radios. Specify manufacturer and model number. Only 25c each. Guaranteed immediate shipment.

**25c**

**SUPREME PUBLICATIONS** 2729 W. 13th St. Chicago, Illinois



# SOUND ENGINEERING

*Free Design and Advisory Service  
For Radio-Craft Subscribers*

Conducted by A. C. SHANEY

*This department is being conducted for the benefit of RADIO-CRAFT subscribers. All design, engineering, or theoretical questions relative to P.A. installations, sound equipment, audio amplifier design, etc., will be answered in this section. (Note: when questions refer to circuit diagrams published in past issues of technical literature, the original, or a copy of the circuit should be supplied in order to facilitate reply.)*

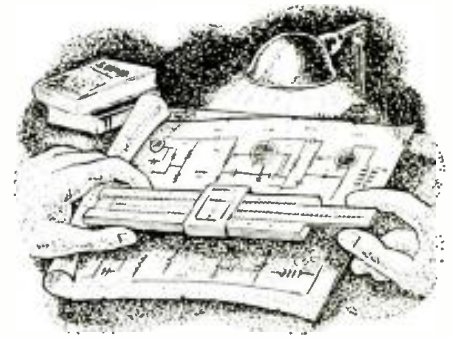

## No. 8

### 20-WATT AMPLIFIER WITH FOUR 6B5'S

#### The Question . . .

I have a 30-watt amplifier which I wish to rebuild to one of higher gain and more inputs without adding too many transformers. Will you kindly send me a sketch covering this. I wish to have 3 microphone inputs and 1 phono, and would like to use two 6SC7 tubes in the input stage, followed by a 6SC7 used for electronic mixer, and 6SC7 for balanced inverter. The final stage should utilize four 6B5's. For the power supply I would like to use a 5Z3 rectifier. Please furnish high- and low-frequency control circuits.

JAMES MOY,  
Chicago, Ill.

#### The Answer . . .

A schematic diagram of the type of amplifier you desire is given in Fig. 1. Your suggested tube line-up would not provide sufficient gain for low-level microphones. I have therefore suggested a 4-stage amplifier instead of 3 stages.

Because of the interelectrode capacities between the plates and grids of the 6SC7, this tube is not recommended as a dual-channel input, unless the gain controls are connected ahead of the input grid. This circuit arrangement, however, would be particularly susceptible to volume control noise, and is therefore not recommended. By using 6SF5's, however, the preamplifier stage is

completely isolated from its adjoining channel, and no cross-talk will be prevalent. Furthermore, the placement of the volume control after the 1st stage, will provide higher-level mixing.

Two 6SC7's are employed as electronic mixers. These in turn feed through the high- and low-frequency equalizers into a 6SC7 inverter. A balanced inverter circuit of the type you require was diagrammed in the April, 1940, issue of *Radio-Craft* (see page 531). The inverter circuit of Fig. 1, however, is of a conventional type and easily constructed and checked. The 7,000-ohm resistor, though, should be made variable for critical adjustments, if perfect inversion is desired. This can best be checked by connecting an oscilloscope to each of the control-grids of the push-pull output stage and adjusting the 7,000-ohm resistor until equal potentials are applied to the push-pull grids.

The power supply should be capable of delivering 220 ma. at 300 volts. The power transformer should deliver about 330 volts under full load. The 1st choke, Ch.1, should be capable of carrying the full output of the supply. The 2nd choke should be capable of handling 50 ma. The output transformer should, of course, be properly matched to the push-pull parallel output stage. You will note that 4 R.F. chokes are inserted in each plate circuit to suppress parasitic oscillations. These, however, may not be necessary. Your preliminary tests will indicate whether or not they should be used.

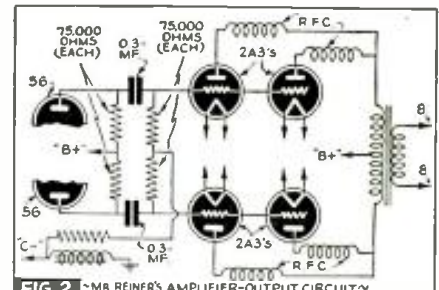
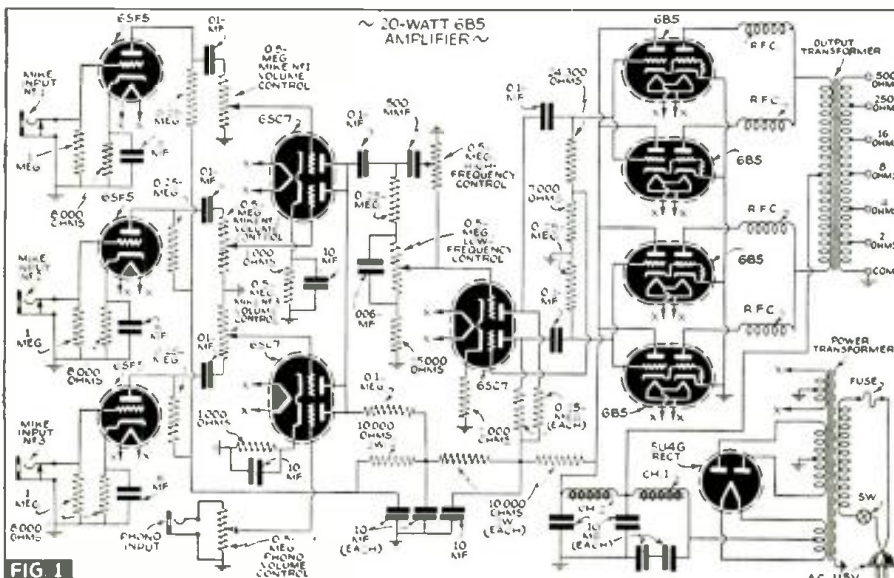

FIG. 2 ~MR REINER'S AMPLIFIER-OUTPUT CIRCUIT~

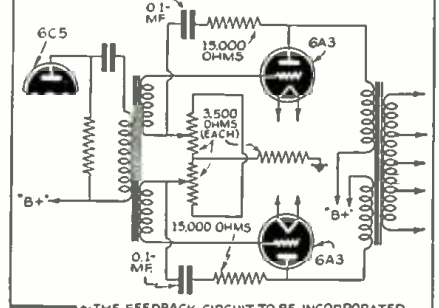

FIG. 3 ~THE FEEDBACK CIRCUIT TO BE INCORPORATED IN THE AMPLIFIER-OUTPUT CIRCUIT OF FIG. 2~

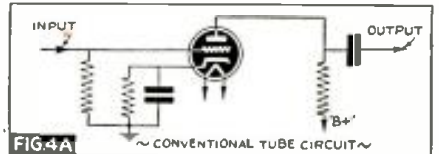

FIG. 4A ~CONVENTIONAL TUBE CIRCUIT~

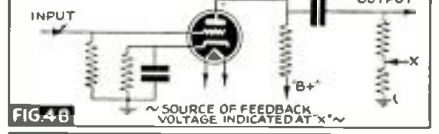

FIG. 4B ~SOURCE OF FEEDBACK VOLTAGE INDICATED AT 'X'~

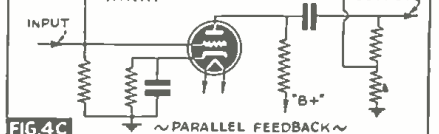

FIG. 4C ~PARALLEL FEEDBACK~

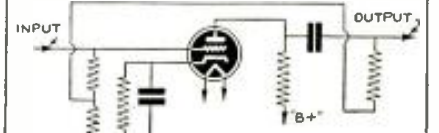

FIG. 4D ~SERIES FEEDBACK~

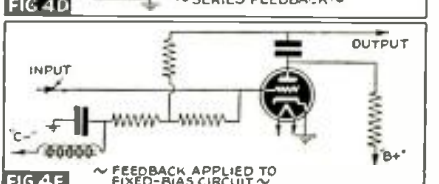

FIG. 4E ~FEEDBACK APPLIED TO FIXED-BIAS CIRCUIT~

# •SOUND•

You can construct these inductances by winding 500 turns of #30 wire on a form 1/2-in. in dia. and 1 1/2 ins. long.

All resistors are of the 1/2-watt type, excepting those marked for higher power.

## PRACTICAL APPLICATION OF INVERSE FEEDBACK

### The Question . . .

I have an amplifier, as per Fig. 2, to

## The NEW DOENUT Horn



Provides  
Wider  
Angle  
Coverage

Model  
DX8B

An entirely new development in exponential horns which provides unique features never obtainable before.

- Spreads high frequencies over a wide angle.
- Weatherproof.
- Wide frequency range.
- No metallic sound.

Write for complete details

### WRIGHT-DECOSTER, Inc.

2251 University Ave., St. Paul, Minn.  
Export Dept.: M. Simons & Son Co., New York  
Cable Address: "Simontrics"

Canadian Representatives:  
Wm. F. Kelly Co., 1207 Bay St., Toronto, Ontario  
Taylor & Pearson, Ltd., Edmonton, Alberta



### YOUR BEST ELECTION BET!

Complete  
"MORNING GLORY"  
Projector, Unit, Bracket  
\$29.40 DEALERS  
NET PRICE

EVERYTHING you can ask for in a high-powered P. M. Speaker for Election sound work . . . 100% Weather and Mechanical Protection . . . High Acoustic Transfer Efficiency . . . Super-Power Projection Qualities. \* It's ruggedly built for sound truck application . . . sturdy mounting bracket supplied. There's no doubt . . . this speaker will win your vote! \* See your jobber or send for FREE CATALOG F-40 describing 101 types of speakers and accessories.

ATLAS SOUND CORPORATION  
1446 39TH STREET BROOKLYN, NEW YORK

which I wish to add inverse feedback. Will you kindly add to my sketch such an arrangement. (I am not too strong on the theory of such arrangements.)

I am, and have been, a *Radio-Craft* subscriber for years. I came across a circuit similar to Fig. 3, which has inverse feedback. I am not certain, however, about being able to adapt this feedback arrangement to my resistance-capacity coupled amplifier. I am trying to get the best possible hi-fi quality.

I thank you for whatever help you can give me.

L. F. REINER,  
Miami, Fla.

### The Answer . . .

Inverse feedback can easily be added to your amplifier. There are many ways of doing this, which will present themselves to you after reading the following description of how to apply inverse feedback.

Unfortunately, most discussions involving the theory of inverse feedback have been steeped in mathematics, and are beyond the scope of the average Serviceman. This has undoubtedly seriously hampered the application of this type of circuit to many amplifiers.

#### SINGLE-ENDED AMPLIFIER

Inverse feedback evolves from the principle of taking some voltage from some point in an amplifier and coupling it back into a previous section of the amplifier, so arranged as to partially buck-out the original signal. This is technically known as feeding the signal back out-of-phase. The

point where it is applied, is known as the *feedback loop*.

Figure 4A shows a conventional tube circuit. If a voltage-dividing network is connected from plate-to-ground, as in Fig. 4B, a small portion of its total voltage will appear at X. This voltage can then be applied to the grid of the tube in parallel with its original incoming signal, as illustrated in Fig. 4C, or in series, as indicated in Fig. 4D. If a bias is to be applied to this stage, the bias resistor is removed from ground and bias voltage is applied through the bias network, as indicated in Fig. 4E. It is important, however, that the low end of the resistance network be bypassed to ground, so as not to affect the feedback arrangement. In applying these feedback circuits, it is of course important not to excessively shunt either the grid or plate circuit of the amplifier itself.

Feedback is applied for any one or all of the following reasons: (1) Reduce distortion; (2) reduce noise and hum within the feedback loop; (3) reduce frequency discrimination within the feedback loop; or, (4) reduce plate resistance of the stage from which the feedback loop is taken.

From the above, it may be seen that if the feedback loop embraces the output transformer, it will compensate for frequency discrimination and distortion introduced by this element. If feedback does loop the output transformer, it is important that the transformer be designed for minimum variation of phase shift with frequency.

#### DOUBLE-ENDED AMPLIFIER

Up to now, we have only considered a

Fig. 5. Balanced inverse feedback applied from balanced output transformer to push-pull stage. Note 1.—The amount of feedback may be varied by varying the 0.75-meg. resistors (R1 and R2). Note 2.—Values of R1 and R2 to be adjusted to provide proper bias for output stage. Balanced tubes should be used in parallel output circuits.

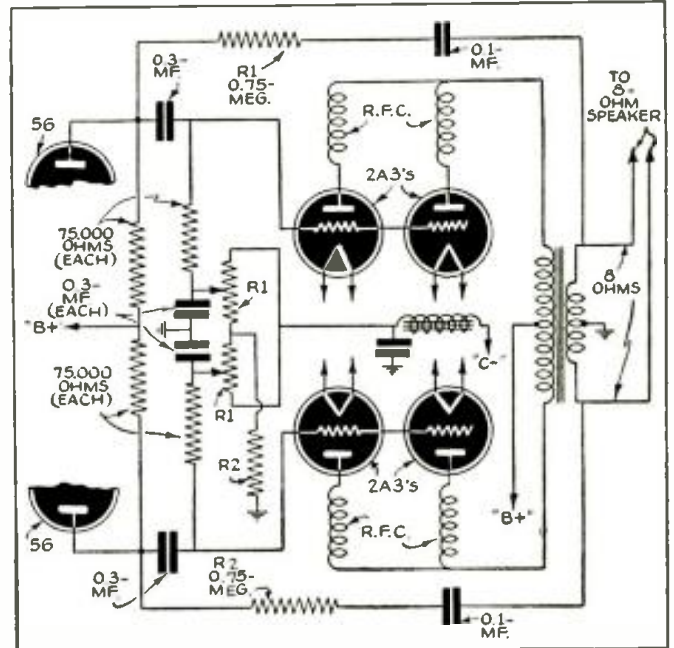

trick in its application is to make sure that the signal which is fed back, is out of phase. When this is done, a loss of gain should be noted. If, however, the signal is fed back in-phase, then we have a condition of regeneration, which usually produces sustained oscillations.

For ideal performance, the signal that is fed back should be exactly 180° out-of-phase with the input signal. In many circuits the feedback signal is exactly 180° out-of-phase at only one frequency. At other frequencies it gradually shifts around to an in-phase condition. This type of circuit produces sustained oscillations, usually at some very high frequency and is always indicative of varying phase shift within the loop of the feedback circuit. The point from where the feedback voltage is taken to the

single-ended amplifier. If feedback is to be applied to a push-pull amplifier, it may be done through one of 2 ways, either (1) from a single-ended signal (as a grounded output transformer secondary) back to a single-ended input stage (as the input of the inverter); or, (2) it may be applied from a push-pull signal (as through a balanced output transformer) back to a push-pull stage, as illustrated in Fig. 5, which is the recommended method for applying inverse feedback to your amplifier.

The value of R1 and R2 should be adjusted for a compromise between the amount of feedback desired and the required stability for the amplifier. The phase of the feedback voltage may be easily reversed by reversing the plate connections of the output transformer.



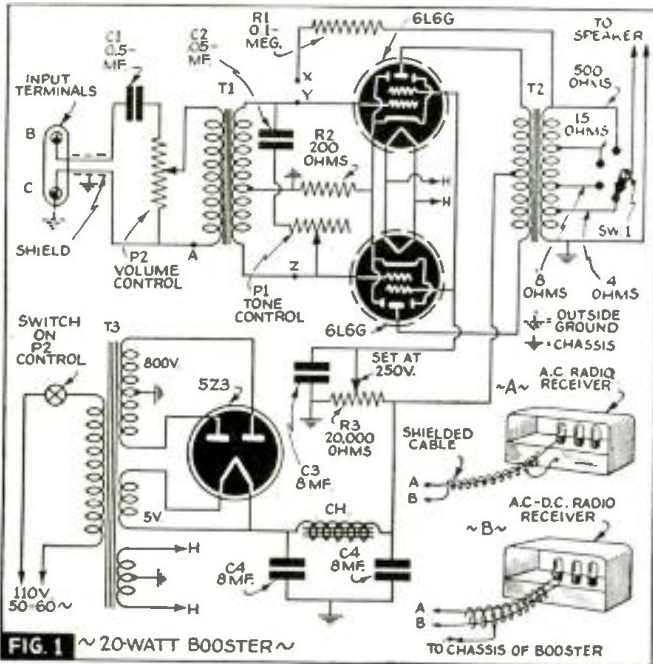
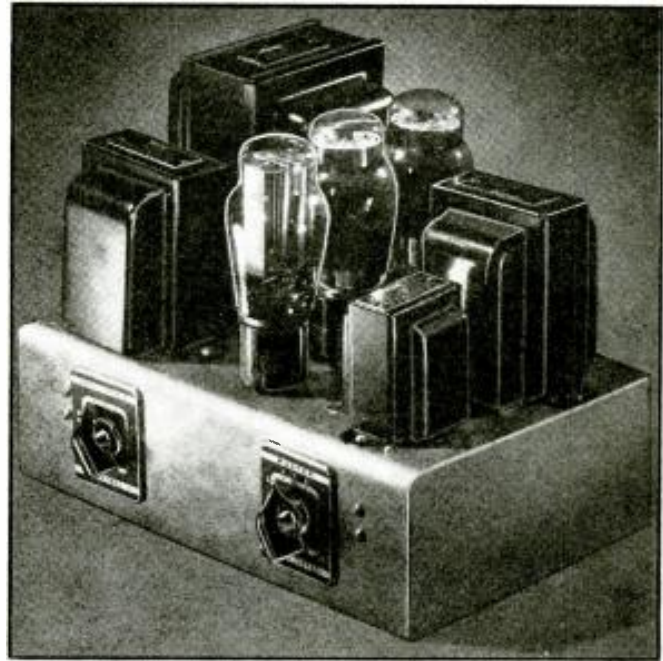

FIG. 1 ~20-WATT BOOSTER~  
Diagram of the 20-W. output stage. (See NOTICE at end of article.)



The completed Booster Amplifier. Power in a small bundle!

## 20-WATT BOOSTER AMPLIFIER

*For Radio Receivers, Low-Power P.A. Systems, Etc.*

*This article describes the construction of an easily-built power output stage which may be added to the "Transitional" P.A. System" described last month. Connected to a \$10 A.C.-D.C. midget, delivering 3 W. with appreciable distortion, this power stage afforded an output of 28 W. with no audible distortion!*

H. T. ZIEGLER

SOMETIMES additional power is required for radio reception, especially in public places such as restaurants, clubs, taverns, etc. With this Booster Amplifier even the smallest A.C./D.C. midget will supply sufficient volume for an audience of 5,000 persons! Phonograph music or carbon mike programs which are fed through the radio set can be amplified also.\*

This power stage can be used also to increase the output of small A.F. amplifiers.

Modern radio receivers have from 3 to 5 watts output, which is sufficient for all ordinary installations. But where a radio set is operated in a public place, additional amplification is necessary.

There are many radio receivers which are furnishing inadequate volume where crowds gather to dance or listen to sports reports, such as baseball and football games, prize fights, etc. Building this Booster Amplifier and installing it in such places should add considerably to the income of any radio Serviceman.

### DESIGN

All unessential parts were left out of the Booster so that it would be installed economically. Fundamentally it is a pair of 6L6G tubes in push-pull, with power supplied from a 5Z3. The entire unit is mounted on a chassis only 10½ ins. long x 7 ins. wide.

\*See the article "Transitional" P.A. System" in the July issue of Radio-Craft for adding a mike to any radio receiver. Add this Booster to have a complete, powerful sound system.

The overall height, with tubes inserted, is only 8½ ins.

The small size of the amplifier permits it to be mounted in the cabinet of console-model radio sets. When used with table-model receivers it can be installed in a separate cabinet or concealed in any convenient place.

Inverse feedback was used to obtain a flat frequency response and to reduce hum and distortion. This was accomplished by connecting the 100,000-ohm resistor from the secondary of the output transformer to the secondary of the input transformer.

All the first experiments were made with the unit connected to a low-price A.C./D.C. superhet. The tone was really excellent and the hum and other distortion were inaudible.

We then connected the stage to a good A.C. superhet. and were surprised at the high quality of reproduction and enormous power.

Finally, we connected it to a frequency-modulated receiver just to make sure that we could handle the high-frequency response.

It is necessary, of course, to use good P.M. speakers with the Booster Amplifier if good tone quality is desired. If the full output is to be used, select speakers which will handle the 20 watts. That is, one 20-watt speaker, two 10-watt speakers, etc. Speakers rated higher than this will be even better, such as one 30-watt speaker, two 20-watt speakers, etc. Do not attempt to use the radio receiver speaker. It will be damaged in a short time.

### PARTS REQUIRED

In the laboratory sample we used the parts recommended in the list at the end of this article. This list need not be followed religiously. Any parts of equal electrical rating may be substituted. Because the average Serviceman will have some of the necessary parts, we decided to give the specifications on all parts which require special explanations.

The input transformer, T1, has a 10,000-ohm primary and a tapped 90,000-ohm secondary.

The push-pull output transformer, T2, is the heavy-duty type to match a pair of 6L6G tubes, having an 8,000-ohm primary,

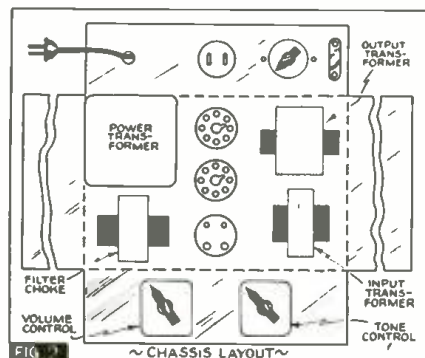

FIG. 2 ~CHASSIS LAYOUT~

and a secondary tapped at 4-8-15-500 ohms. If the amplifier is to be used with a specific speaker or set of speakers, the tapped secondary is not necessary, permitting the use of a lower priced transformer, one which will directly match the speaker system used.

The power transformer, T3, must have a 5-volt secondary winding for the filament of the 5Z3; a 6.3-V. secondary for the 6L6G filaments, and an 800-volt center-tapped secondary winding for "B" current. The high-voltage winding should be capable of delivering at least 180 ma.

**CHASSIS LAYOUT**

On the top of the chassis are all the transformers, a 4-contact socket for the 5Z3, and 2 octal sockets for the 6L6G tubes.

On the front of the chassis are 2 potentiometers, 1 for the tone control and 1 for the volume control.

On the back of the chassis is a tap switch for matching the unit to the speakers. (Note: The only tap switch available was marked 4-8-15-250-500. If the transformer, like ours, has no 250-ohm tap, this point on the switch is simply left unwired.)

A 2-pole A.C. receptacle is installed on the back of the chassis for connecting the speakers. Two such receptacles can be used, if desired, wired in parallel.

Also on the back of the chassis is a 2-post terminal strip as the connection for the incoming radio receiver wires.

No special wiring instructions are necessary. Simply follow the wiring diagram. Use a shielded lead from the terminal strip to the primary of the input transformer.

The wire marked "X" should be tried at points "Y" and "Z" after the unit is completely assembled and is in operation. At one point regeneration will be introduced

and the reproduction will become distorted; at the other point the volume may drop slightly, but reproduction will be improved.

**OPERATION**

Only a single shielded wire is required to connect the Booster Amplifier to the receiver for A.C. sets. (Connecting to A.C./D.C. radio sets is explained later.) The center conductor is terminated in a clip which slips onto the plate prong of the output tube in the receiver. The shield is connected to the radio receiver chassis. When the receiver uses push-pull tubes, connect the wire to either plate.

For A.C./D.C. radio sets 2-wire shielded cables must be used to connect the set and amplifier. One wire is connected to the plate of the output tube and the other to the cathode. The shield is connected to the chassis of the Booster.

If there is any grid noise present because of the leads between the receiver and the amplifier, connect one side of the power stage input transformer primary to the chassis.

**LIST OF PARTS**

- One Thordarson input transformer No. T67A40, T1;
- One Thordarson output transformer. No. T65S94, T2;
- One Thordarson power transformer. No. T92R21, T3;
- One Thordarson choke. No. T17C00-B. ch.;
- One paper condenser, 0.5-mf., C1;
- One paper condenser, 0.05-mf., C2;
- One Mallory electrolytic condenser. No. CS-133, 8 mf., 450 V., C3;
- One Mallory electrolytic condenser. No. CN-152, 8-8 mf., 450 V., C4;
- One resistor, 0.1-meg., 1/2-W., R1;
- One resistor, 200 ohms, 10 W., R2;

- One voltage divider, 20,000 ohms, 25 W., R3;
- One Centralab potentiometer with switch, No. 62-116, 1 meg., P1;
- One Centralab potentiometer, No. 72-121, 0.25-meg., P2;
- Two Amphenol octal sockets, S-8;
- One Amphenol 4-contact socket, S-4;
- One Amphenol receptacle, 61-F;
- One Amphenol polarized plug, 61-MP11;
- One Amphenol tap switch marked 4-8-15-250-500, 36-1, Sw. 1;
- One line cord with plug;
- Misc. (nameplates, knobs, etc.).

(The author offers to answer any inquiries regarding the building or adaptation of the 20-Watt Booster Amplifier to any radio set. If a particular radio receiver is referred to, please give make, model number and tube line up. An addressed, stamped envelope will be appreciated.)

**NOTICE.**—An error, caught too late to permit changing the illustration, exists in detail drawings A and B in lower-right of the schematic diagram of the complete 20-W. Booster Amplifier. In sketch A a single-conductor shielded cable is used for connecting the Booster to an A.C. receiver. Center conductor of cable is connected from "A" terminal of Booster to plate of receiver output tube.

In sketch B a 2-conductor shielded cable is used to connect the Booster to any A.C.-D.C. receiver. Wire "A" connects plate of receiver output tube to terminal "A" in the Booster. Wire "B" connects to cathode of output tube (or any terminal which is connected to "B-"). This wire "A" connects to terminal "B" of the Booster. The cable shield is not connected to the receiver chassis, but it is connected to the Booster chassis.

*This article has been prepared from data supplied by courtesy of Allied Radio Corp.*

*Mr. Radio Serviceman:*

**A NEW SEASON BEGINS—  
MOVE FORWARD WITH RSA!**

Plans announced at the Radio Parts Trade Show make it more imperative than ever that you belong to RSA. All the new developments planned by manufacturers place increased responsibility on trained top-flight servicemen. Join other good servicemen in RSA. Send the Coupon Today!

**MAIL THIS COUPON NOW!**

RADIO SERVICEMEN OF AMERICA, INC.  
304 S. Dearborn St., Chicago, Ill.

Name .....

Address .....

City ..... State .....

I am interested in RSA Membership. Tell me about it.

I am enclosing \$4.00 for National dues and initiation. Covers dues up to Jan. 1, 1941.

(Does not include Local Chapter dues where Local Chapters are organized.)

RC-840

*Let's Grow Together  
in 1940!*



**RADIO SERVICEMEN  
OF AMERICA, Inc.**

**JOE MARTY, JR., EXECUTIVE SECRETARY  
304 S. DEARBORN STREET, CHICAGO, U.S.A.**



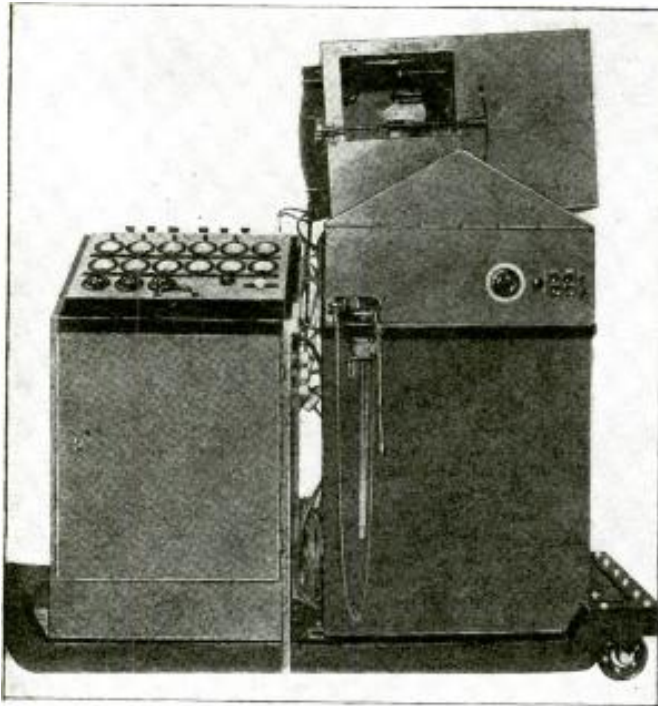

Side view of RCA projection-television apparatus.



N.B.C.'s Ray Monfort, and projection Kinescope; left, projection lens.

## NEWEST SCREEN-SIZE TELEVISION

*Not yet on the market, is the newest type of projection television receiver here described, which permits viewing by 150 persons. A feature of the system is the use of an enlarging mirror in place of the lens system ordinarily used!*

**A** NEW large-screen television system of the type designed for use in theaters and before large audiences was demonstrated last month at the annual stockholders' meeting of the Radio Corporation of America in the RCA Building, Radio City, New York.

The demonstration, first public showing of the unit, was featured by an outstanding program of entertainment. Among those who appeared on the television screen were Madame Kerstin Thorborg, distinguished contralto of the Metropolitan Opera Company; Lowell Thomas, 4 1st-chair men of the NBC Symphony Orchestra, and other well-known artists.

**WALL-SIZE IMAGES.**—Although the RCA Laboratories have been working several years in the field of large-screen television, the particular system shown was completed early this year. A laboratory model, it projects images 4½ x 6 feet in size onto an ordinary beaded motion picture screen. The projected pictures compare in brightness with motion pictures and are considered to have definite entertainment possibilities.

The unit was built as an intermediate step in the development of apparatus for the projection of much larger images, but it has already become apparent that the 4½ x 6 foot image has interesting possibilities for use in clubs, schools and other similar places where the viewing group numbers from 100 to 150 persons. The Company has no immediate plans for marketing this apparatus. At least 12 months would be needed to develop it commercially.

**3-UNIT CONSTRUCTION.**—The apparatus consists of 3 parts. One contains the newly developed kinescope projection tube and the optical system. Another contains the high-

voltage power supply, and the 3rd houses the electrical circuits, amplifiers, and controls. All 3 are assembled on a single mobile platform. The overall dimensions are: length, 6 ft., width, 2 ft., and height, 5½ ft.

**56,000 VOLTS.**—The new kinescope uses 56,000 volts as compared with the 6,000 or 7,000 volts used by the kinescope in the ordinary home-type television receiver. The actual size of the image on the face of the kinescope projection tube is 2.4 by 3.2 inches. The television signals are brought to the kinescope by either an antenna system, which takes them off the air, or by a direct wire line from the source of the program. In the demonstration, the signals were taken off the air as broadcast by the National Broadcasting Company's transmitter, W2XBS, atop the Empire State Building.

**MIRROR LENS.**—The optical system of the

unit has an effective numerical aperture of F:0.7, or more than 4 times the speed of the best available projection lenses. This means an increase in screen brightness of more than 4 times.

The brightly-illuminated image on the surface of the kinescope, which faces in the opposite direction to that of the finally projected picture, is thrown upon a *concave mirror* surface measuring 16 inches in diameter. The mirror collects the light and magnifies the image 22½ times. The image is then projected back through a glass lens surrounding the neck of the kinescope, and thence 20 ft. through space to a screen mounted on a wall. The system effectively utilizes the industry television transmission standards formulated by the Radio Manufacturers Association: 441-line definition and 30 frames per second.

The new RCA large-screen television system, here shown in cross-section, is based on projection optics of extremely wide aperture, a kinescope capable of high-voltage operation, and apparatus suited to these conditions. Most essential elements are the new kinescope projection tube and the optical system. These provide more light and utilize it more effectively than ever before, so that large-screen television becomes practical.

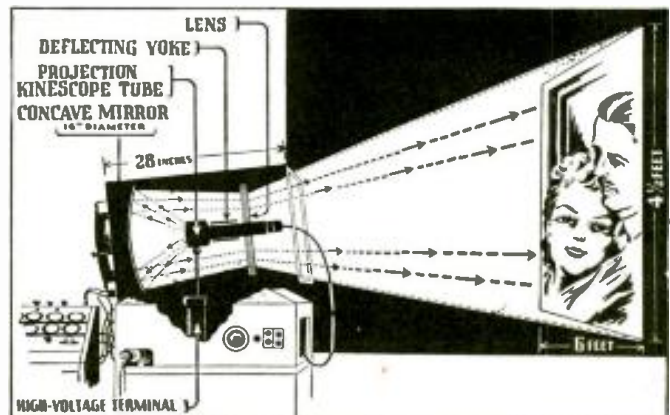

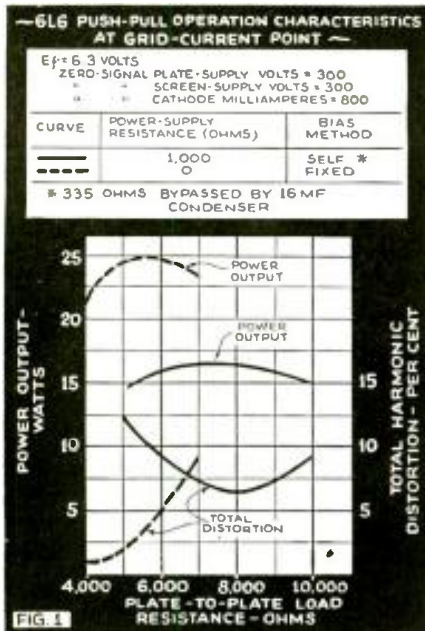

Distortion vs. power output of push-pull 6L6 stage with zero-ohm and 1,100-ohm resistance power supplies.

THE need for a stabilized constant voltage power supply has undoubtedly been felt by many laboratory technicians who are constantly developing new electronic devices for accurate measurements. A constant voltage supply is also necessary for stable operation of communication systems involving the use of oscillators, which are subject to frequency drift with variations in voltage. In addition to these, many precision electronic instruments require a constant voltage under all conditions of operation.

High-power amplifiers operating in A1, AB1, AB2 or class B similarly require a stabilized voltage supply for attainment of maximum power output with minimum distortion. In fact, the importance of power

Controlling the degree of saturation in an ingenious magnetic-circuit arrangement makes possible a power supply having automatic regulation within wide limits.

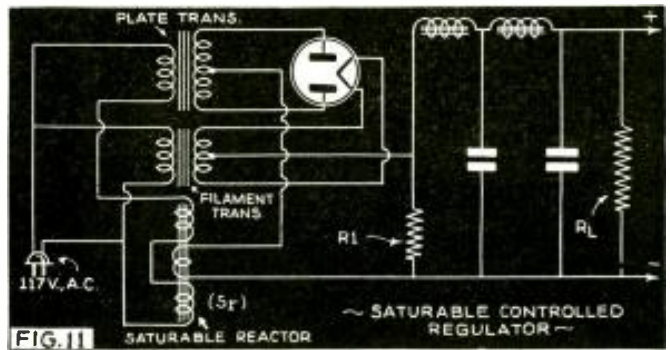

## The Fundamentals of CONSTANT-OUTPUT D.C. POWER SUPPLIES

This article describes 3 conventional types of regulated power supplies; and concludes with the engineering details of a D.C. power supply unit capable of regulating the output within 1 per cent under a load change of 300 per cent!

A. C. SHANEY

supply regulation is usually overlooked by many amplifier design engineers.

Figure 1 shows the power output versus total distortion of a class A1, 6L6 amplifier operating with a power supply having perfect regulation (or 0 internal resistance), as against the same circuit with a more or less standard power supply having an internal resistance of 1,000 ohms. A careful examination of the dotted curves (which is the condition obtained with a 0-resistance power supply) will disclose that approximately 23 watts is available at 1.5% of total distortion. An output of 25 watts is available at 3.5% distortion. The solid curves show that with a conventional power supply, this same circuit, under optimum conditions, will produce only 16.5 watts at 6.7% total distortion. These characteristics should not be construed as applying to a 6L6 amplifier only. In fact, the 2A3 tube is subject to the same detrimental effects of poor regulation.

Figure 2 indicates power output versus distortion curves for various types of supplies for a push-pull 2A3 amplifier. It will be noted that a plate and bias supply having 0 resistance (see curve 1) will enable the attainment of 16.6 watts at 1.4%, whereas a plate and bias supply, having internal resistance of 780 ohms, will attain only 11 watts at 2% distortion. Naturally, poorer power supplies will produce more distortion at equivalent power levels.

### REGULATION

Regulation of a power supply may be expressed as the ratio of the change in output voltage to the highest output voltage. Expressed mathematically, this ratio may

be written as  $\frac{E\Delta}{E_0}$ . Percentage of regulation can be calculated from the following formula:

$$\% R = \frac{E\Delta}{E_0} \times 100 \quad (1)$$

where

$E_0$  = Highest voltage output  
 $E\Delta$  = Output voltage change

If a power supply produces no voltage change under full- and no-load conditions,

it naturally would have "0 regulation." The term "regulation" does not always give a true picture of the operating characteristics of the power supply, unless the changes in current are taken into consideration. The regulation of a power supply may also be expressed as a function of its internal resistance. For example, a power supply which delivers 200 volts under no load, and 195 volts under the full load, would be said to

have a regulation of  $\frac{200-195}{200} \times 100 = 2\frac{1}{2}\%$ .

Its internal resistance, however, can be calculated from the following formula:

$$R_i = \frac{E\Delta}{I\Delta} \quad (2)$$

where

$R_i$  = internal resistance  
 $E\Delta$  = change in output voltage  
 $I\Delta$  = change in output current

For example, a power supply which delivers 205 volts at a load current of 100 milliamperes, and 200 volts at a load current of 125 ma., would have an internal resistance of  $\frac{205-200}{.125-.100}$  which is equal to

$\frac{5}{.025} = 200$  ohms. It will be noted that

the internal resistance of a power supply combines in one term, the ratio of voltage regulation to current change.

### CLASSIFICATION OF D.C. REGULATED POWER SUPPLIES

Regulated D.C. power supplies may be broadly classified into 3 groups. Group No. 1 employs a cold-cathode glow discharge tube similar to the ordinary neon lamps, or other radio versions of the Sylvania VR90, VR150, and the RCA 874.

Group No. 2 employs a grid-control vacuum tube, the exact type, depending upon the control range desired.

Group No. 3 employs a saturable reactor in series with the plate supply transformer. It will be noted that all 3 are of the electronic type and employ no moving parts. A discussion of the fundamental circuits and

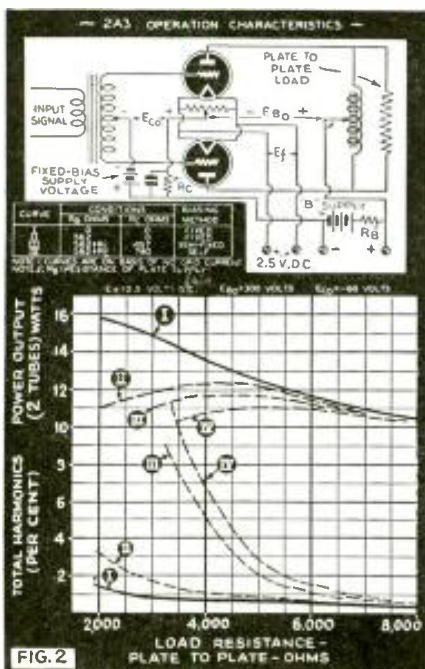

Distortion vs. power output of push-pull 2A3 amplifier with various types of power supply.



operating principles, as well as limitations of application of these 3 types follow:

**COLD-CATHODE GLOW DISCHARGE REGULATORS**

To best understand the operating characteristics of this type of a regulator, let us refer to Fig. 3, which shows a D.C. generator in place of the conventional power supply filter network feeding a resistor,  $R_b$ , in series with the load  $R_L$ , having an additional variable resistor  $R_c$  connected across it. If a milliammeter is inserted in the load circuit, and if the load is varied, so as to draw more or less current, it can be seen that an appropriate adjustment of  $R_c$  will always maintain a constant voltage across  $R_L$  within the operating limits of the circuit.

When the load draws more current, it means that its internal resistance is decreased. Now, if the control resistor  $R_c$  is increased, by a compensatory amount, the voltage  $E_o$  across the load will remain constant. Resistor  $R_b$  is inserted into the circuit to act as a "ballast" so that excessive voltage may be "absorbed." If a grid-glow discharge tube is inserted in place of  $R_c$ , Fig. 4 results. This is a characteristic grid-glow discharge circuit.

A casual study of regulating characteristics of both the Sylvania VR90 and VR150 (see Fig. 5), will disclose that a practically constant drop is maintained across these regulators under wide conditions of variations of current through them. Another way of looking at the regulating characteristic of this type of tube, is to view the regulator as being able to maintain a constant voltage drop across itself.

It is to be noted, however, that these tubes operate in a comparatively limited range. In other words, more than 30 ma. should never be passed through them. It will also be noted that the operating range of the VR150 is from 5 to 30 ma., which gives us an effective range of 25 milliamperes. Under these conditions of operation, the voltage across the tube will change from approximately 146 to 150. If this tube is placed across the output of a regulated supply, the internal resistance of the supply (within the operating range of the regulator) will be according to formula (2)

$$\frac{150-146}{30-5} = 80 \text{ ohms.}$$

The internal resistance of a power supply utilizing VR90 would be approximately 300 ohms.

The advantage of this type of circuit is that it compensates for variation in line voltage, as well as for variations in load current. The effective control range is materially reduced, if large variations in power line supply voltage occur. The disadvantage of this type of regulator is that it operates over a comparatively limited range, wastes an appreciable amount of power in the series resistor ( $R_b$ ), and it can only be applied to supplies that are to deliver 90 volts, 150 volts or multiples of these voltages.

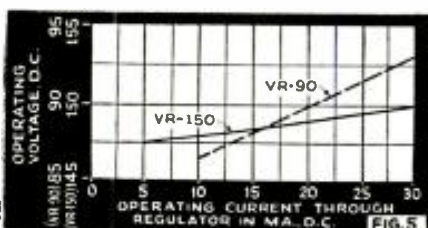

Fig. 5. Typical regulation characteristics of cold-cathode glow discharge tubes.

**GRID-CONTROLLED VACUUM TUBE REGULATOR**

To simplify the explanation of the operating principles of this type of regulator, let us refer to Fig. 6, wherein  $R_c$  is connected in series with  $R_L$ . The voltmeter  $E_o$  is connected across  $R_L$  and an ammeter,  $I_o$ , connected in series with  $R_L$ . Under this condition of operation, it can readily be seen that if the load current increases ( $R_L$  decreases), the voltage across  $R_L$  ( $E_o$ ) may be brought back to its original value by decreasing  $R_c$ . Similarly, if the load current decreases ( $R_L$  increases) then the voltage  $E_o$  may be decreased by increasing  $R_c$ .

If  $R_c$  is now supplanted by a tube, as illustrated in Fig. 7, the plate resistance of the tube (from plate to filament) may be controlled by the bias applied to the controlled grid. Figure 8 shows such a circuit. To increase the sensitivity of the control voltage, a voltage amplifier (6F5) is employed to amplify the variation in line voltage. This, in turn, changes the bias in the regulator tube, which increases or decreases its plate resistance.

It will be noted that a number of grid-glow discharge tubes are used in this circuit to maintain a constant voltage across critical points. (These grid glow discharge tubes may be the small 2-watt neon lamps with their internal resistors removed.) For example, 1 tube is employed in series with the cathode of the 6F5. This insures a constant cathode voltage. Three additional tubes are connected in series from the high side of the supply directly to the grid. This arrangement insures that the total voltage change at the output is applied to the grid of the voltage control amplifier.

If we assume that the output voltage should drop from 300 to 290 volts, this 10-volt total change is applied to the grid of the 6F5 because the voltage drop across the 3 series neon tubes remains 180 volts at all times. This 10-volt change decreases the bias on the 6F5 (the neon tube in the cathode circuit keeps the cathode potential constant under all conditions of voltage variation of the output circuit), which increases the plate current through the control amplifier, this in turn, increases the drop across the 1-meg. series resistor of the control tube. This increase in drop decreases the bias of the control tube, which in turn decreases its plate resistance, and enables more current to flow through it to compensate for the increased current of the output, so as to bring the voltage back to its normal point.

The type of control tube employed, depends upon the amount of current desired from the regulated supply. A 2A3 is normally employed to control changes in current up to 60 milliamperes. The normal voltage drop from plate to heater of the control tube, should be adjusted so that maximum plate dissipation is not exceeded under any condition of operation. The maximum regulating range of a single 2A3 tube is approximately 60 milliamperes. A fixed resistor across the controlled tube will increase the available current, but will not increase the regulating range. Where increased regulation is essential, 2 more control tubes may be connected in parallel. An experimental model employing a single regulator tube with a shunt resistor across it, delivers 400.5 volts at 230 ma. and 399.7 volts at 280 ma. This would indicate an internal resistance of 16 ohms. Another variation of this circuit employing a 6J7 pentode voltage control amplifier tube is given in Fig. 9. This circuit employing a single 2A3 is capable of delivering 202 volts at 10 ma., and 199.5 volts at 70 ma., which is equivalent to having an internal resistance of

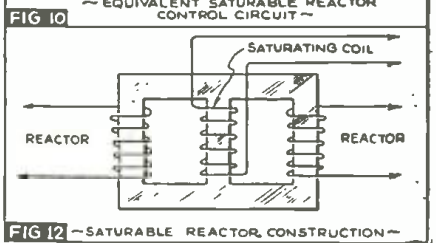
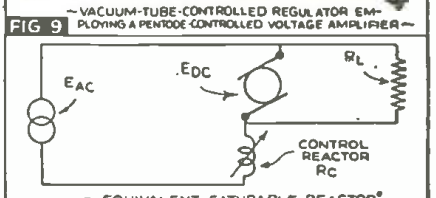
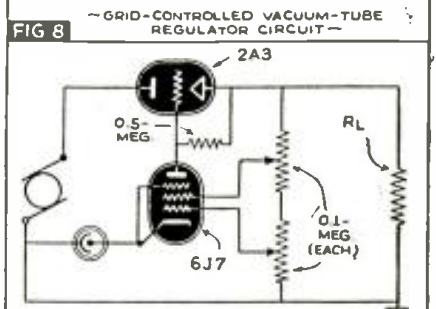
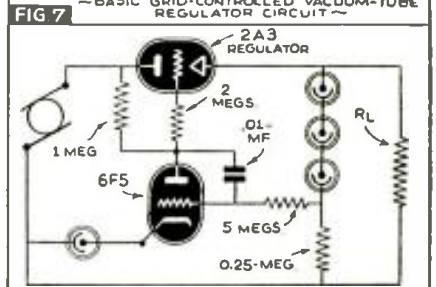
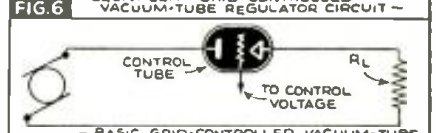
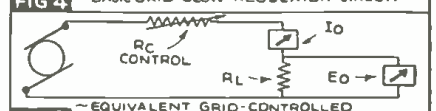
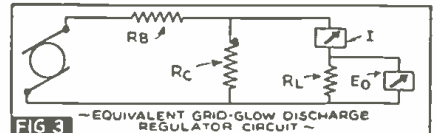

approximately 41.7 ohms. With two 2A3's connected in parallel, this same circuit delivers 205 volts at 20 ma., and 200 volts at 140 ma. Its internal resistance remains the same.

The advantage of this type of circuit is that it provides regulation for variations in load current and variations in line voltage. Its disadvantage, however, is its comparatively limited operating range, appreciable waste of power across the controlled tube, and the necessity to stabilize the operation of the neon tubes.

This type of regulated power supply has become very popular because of its comparative simplicity and economy.

**SATURABLE REACTOR VOLTAGE REGULATOR**

The saturable reactor type of regulator employs a distinctive principle of operation. The fundamentals involved can easily be understood by referring to Fig. 10, wherein an A.C. supply, Eac, is connected in series with the control reactor, Rc, and a rotary converter, Edc, which produces direct current for the load Re. If the current through Re is increased, the voltage across Edc will naturally decrease. However, a decrease in the control reactor will increase the A.C. potential across the rotary converter, so as to increase its output back to its original value. Similarly, a decrease in load current will tend to increase the output of the rotary converter. However, by increasing Rc, the voltage applied to the converter would be decreased and its output would be likewise affected. If we now substitute a conventional power supply for Edc and a saturable reactor Sr for Rc, as diagrammed in Fig. 11, we have the fundamental circuit of a saturable reactor voltage regulated supply.

The operation of the saturable reactor, Sr, can best be understood by referring to Fig. 12, wherein it will be noted that 3 coils are wound on the 3 legs of a standard type EI lamination. The outer 2 coils, known as the *reactors*, are connected in series-aiding. The drop across the reactors will be proportional to the permeability of the core.

This in turn, however, is controlled by the amount of current passing through the center winding, called the *saturating coil*. The more D.C. that flows through this coil, the lower will be the permeability of the entire core. As this permeability decreases, the inductance of the reactors decreases, and the voltage drop across them decreases.

As the saturable reactor is connected in

series with the primary of the plate transformer, any decrease across the saturable reactor appears as an increase across the primary of the plate transformer. This in turn increases the plate voltage supplied to the rectifier which raises the output of the power supply.

This control action can be made entirely automatic by passing a portion of the output current through the saturating coil. Referring back to Fig. 11, it will be noted that the center-tap of the high-voltage A.C. winding is connected through the saturable coil into the load. Resistor R1 is placed across the output of the rectifier, but in series with the saturable coil so as to set the permeability of the saturable reactor at its correct operating point on its permeability curve. If the load current through RL is increased, an increase in voltage drop takes place in the filter choke Ch1, Ch2. The increased current, however, saturates the series reactor, decreases the voltage drop across the reactor coils, increases the voltage across the primary of the plate transformer, and across the rectifier plates, which in turn appears as increased voltage at the input of the filter, to cancel the normal drop across the filter chokes.

The range of this type of reactor is limited only by the type of rectifier tube employed. It can easily be extended up to many amperes. It likewise operates efficiently at currents commonly encountered in laboratory equipment or commercial amplifiers. Typical regulation characteristics of experimental models follow:

Regulation Current Range (in Ma.)	Voltage Output	Internal Resistance (in Ohms)
20 to 140	206-204	33.4
0 to 80	169-168	12.5
120 to 240	212-210	16.7
140 to 300	204-202	12.5

100 to 300	201-200.5	2.5
0 to 300	200-197	10.0

With slight variations in circuit design, the power supply can be made to have a negative resistance characteristic. In other words, the output voltage may be made to rise with an increase of load current.

Characteristics of still another type produces the following rise in voltage with an increase of current:

Output Current	Output Voltage	Output Current	Output Voltage
20	140	180	173
40	143	200	175
60	148	220	176
80	154	240	176.5
100	158	260	177
120	164	280	177.5
140	168	300	178
160	170		

This type of regulation characteristic is only available with power supplies having a *negative internal resistance*. The actual negative resistance can be calculated from (2) as follows:

$$R = \frac{140-178}{.300-.020} = \frac{-38}{.280} = -136 \text{ ohms (approx.)}$$

A great advantage of this circuit is that no power is dissipated. The voltage drop which appears across the saturating coils, is not in phase with its current, because the load is of an inductive nature. The disadvantage of this supply, however, is that it does not compensate for line voltage fluctuations. This condition may be corrected by using a conventional A.C. voltage regulator ahead of the power supply.

The author will be pleased to answer any questions relative to this article, if a stamped addressed envelope is enclosed. Simply address inquiries c/o Radio-Craft.

**WHAT CAUSES ECHO, FADING?**

**N**EXT time your customer waxed irate at the results he gets on his allwave radio receiver, let him see this item, which tells in the words of the Engineering Division of the British Broadcasting Corp. some of the reasons why listeners may sometimes experience echo, fading, distortion and other effects when listening to, let us say, one of the B.B.C.'s Overseas Stations.

"Echo" effect is rarely to be observed on waves longer than those in the 19-meter (15 megacycles) band, which means, usually, that on transmissions from one of the B.B.C.'s Overseas Stations the effect is most likely to be observed by listeners in India, Malaya, and Australia—and possibly the West Indies—during Transmissions 2 and 3. (The same principles apply in receiving short-wave programs in America, of course. —Ed.)

All the aerials used at the B.B.C. short-wave station for wavelengths below 20 meters are fitted with reflectors, the effect of which is to concentrate the radiated energy in one direction when it leaves the aerial. When propagation conditions are particularly favorable, it may happen that a frequency in, say, the 13-meter band, such as G5J, may provide strong signals in India, and still be of sufficient strength to travel onward, until, having completely encircled the globe, it provides a second signal at the same point of reception.

When such "round-the-world" or "forward" echo takes place, the interval between successive signals is of the order of 1/7-second—there are authentic accounts on record of as many as 5 or 6 separate repetitions of a single signal. It will be seen that

if a news bulletin, for example, is being read, and conditions bring about the echo effect described, then the distortion produced may make the program practically unintelligible. Although, as is shown below, certain types of echo may be overcome by the use of reflectors at the *receiving* end, the type referred to here cannot be suppressed in this way.

A 2nd form of echo, sometimes called "backward echo," takes place when the transmitting aerial used is not equipped with a reflector. From such aerials energy is radiated in equal amounts in opposite directions. If the point of reception is not equi-distant from the transmitter over both paths, and if conditions are well suited to the frequency concerned, then signals may

be received from both directions. Since the 2 paths are of unequal length, the time taken for the signal to arrive will not be the same from both directions, and echo may again be produced, the time interval being determined by the difference in the 2 path lengths.

This effect can also be produced even when the radiating aerials are equipped with reflectors, for it would be both difficult and costly so to design them that the whole of the energy radiated would be concentrated in the one direction. With the arrays actually used by the B.B.C., a small amount of energy escapes in the direction opposite to the line of maximum radiation.

When conditions are suitable, as, for instance, on 13 meters and 16 meters in Transmissions 2 and 3, serving India, this small amount of escaping energy is sufficient to provide useful signals at relatively great distances from the transmitters. The "Great-Circle" route from Britain to the West Indies happens to be almost exactly in the opposite direction to the route to India, and listeners in the West Indies will, no doubt, be well aware that frequencies G5J and G5G often provide useful signals there when primarily intended to serve India.

It may be possible, when propagation conditions are particularly suited to those frequencies, for listeners in the West Indies to observe the effect of echo due to the signals' arriving by the shorter route direct from Britain, and also by the long path across India and so round the globe. This type of echo may be reduced by the use of reflectors on the receiving aerials.

**MORE BROADCASTING**

**H**ERE'S a toast to folk like Mickey Rooney, a fellow of simple tastes, who has 15 "radios" in his 18-room mansion. . . Listen-in for Morton Gould's series of compositions, "Experiments for Radio Orchestra." This young composer-conductor plans to air over WOR-Mutual a series of 2-minute "experiments" which "emphasize the tonal configurations that previously served only as a lace-like fillet" (my, my). Such compositions as "4 Flutes and a Filter-Mike," and "Bassoon, Viola and Echo-Mike Study," he hopes will aid young composers who are studying effects possible in radio. The heretofore background sounds will be acoustically spotlighted. . .



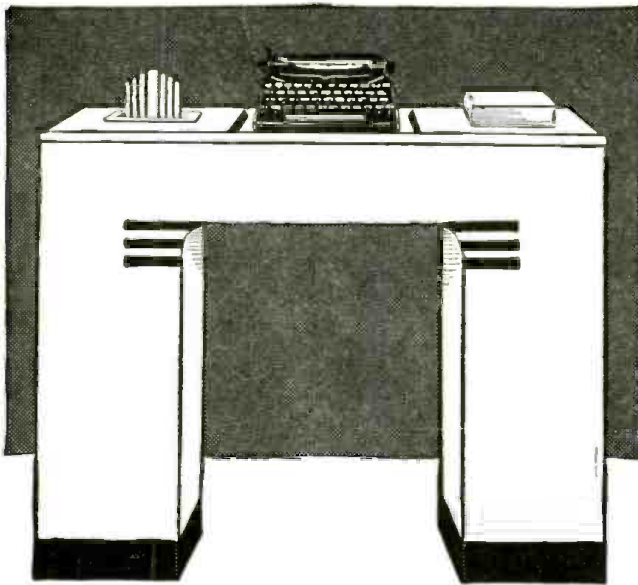

**THIS  
BEAUTIFUL DESK  
for only \$1.00 EXTRA**

**WITH ANY  
REMINGTON  
PORTABLE TYPEWRITER**

A beautiful desk in a neutral blue-green which will fit into the decorations of any home—trimmed in black and silver—and made of sturdy fibre board—is now available for only one dollar (\$1.00 extra) to purchasers of a Remington Noiseless Portable Typewriter. The desk is so light that it can be moved anywhere without trouble—it is so strong that it will hold six hundred (600) pounds. With this combination of desk and Noiseless Deluxe Portable Typewriter, you will have a miniature office at home. Learn the complete details of this offer. Mail the coupon today.

*The*  
**COMBINATION**  
FOR AS LITTLE AS  
**10¢ A DAY**

How easy it is to pay for this combination of desk and Remington Deluxe Noiseless Portable Typewriter! Just imagine, a small good will deposit with terms as low as 10c a day to get this combination at once! You will never miss 10c a day. Yet this small sum can actually make you immediately the possessor of this amazing office-at home combination. You assume no obligations by sending the coupon.

**THESE TWO EXTRA FOR YOU**

**LEARN TYPING FREE**

To help you even further, you get free with this special offer a 32-page booklet, prepared by experts, to teach you quickly how to typewrite by the touch method. When you buy a Noiseless you get this free Remington Rand gift that increases the pleasure of using your Remington Noiseless Deluxe Portable. Remember, the touch typing book is sent free while this offer holds.



**SPECIAL CARRYING CASE**

The Remington Deluxe Noiseless Portable is light in weight, easily carried about. With this offer Remington supplies a sturdy, beautiful carrying case which rivals in beauty and utility the most attractive luggage you can buy.



**SPECIFICATIONS**

ALL ESSENTIAL FEATURES of large standard office machines appear in the Noiseless Portable—standard 4-row keyboard; back spacer; margin stops and margin release; double shift key and shift lock; two color ribbon and automatic ribbon reverse; variable line spacer; paper fingers; makes as many as seven carbons; takes paper 9.5" wide; writes lines 8.2" wide. There are also extra features like the card writing attachment, black key cards and white letters, touch regulator, rubber cushioned feet. These make typing on a Remington Deluxe Noiseless Portable a distinct pleasure. Thousands of families now using the Remington Deluxe Noiseless Portable know from experience how wonderful it is!

**MONEY BACK GUARANTEE**  
The Remington Noiseless Portable Typewriter is sold on a trial basis with a money back guarantee. If, after ten days trial, you do not wish to keep the typewriter, we will take it back, paying all shipping charges. You risk nothing in buying a Remington Portable Typewriter on terms as low as 10c a day.



**MAIL  
COUPON  
NOW!**

Remington Rand Inc., Dept. 189-8  
465 Washington St., Buffalo, N. Y.

Tell me, without obligation, how to get a Free Trial of a new Remington Deluxe Noiseless Portable, including Carrying Case and Free 32-page Typing Instruction Booklet on terms as low as 10c a day. Send Catalogue.

Name .....

Address .....

City ..... State .....

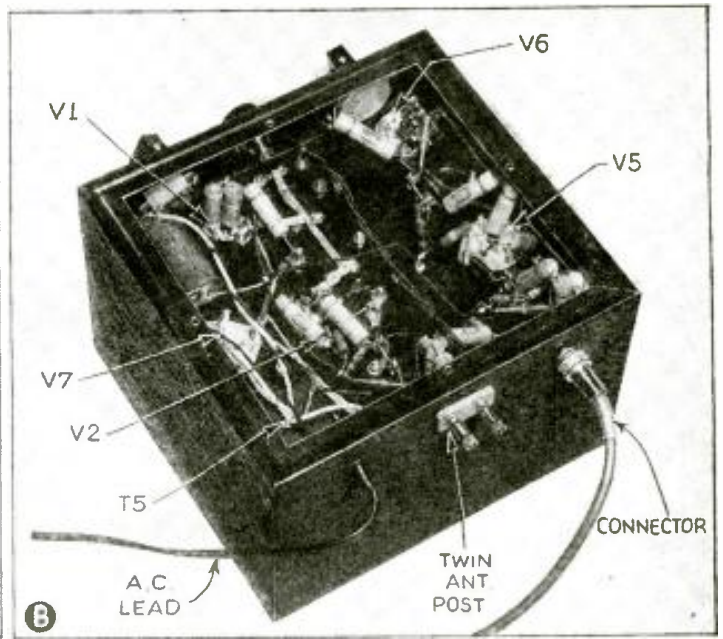
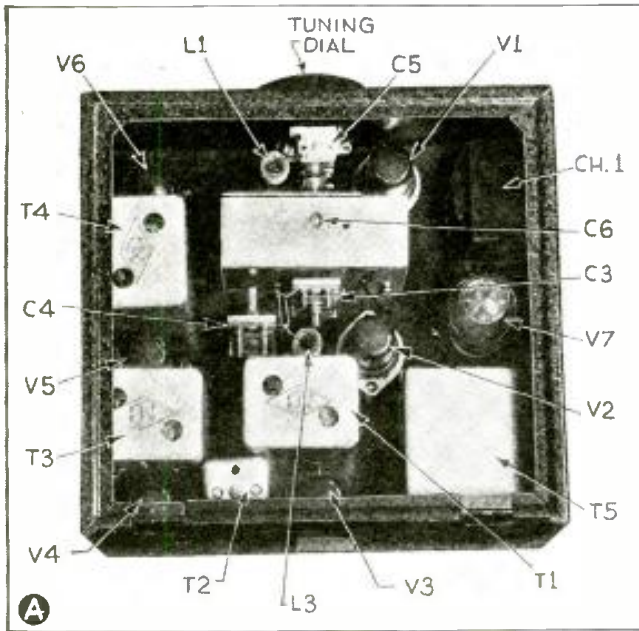

The neat and compact construction of this new F.M. Adapter is illustrated in photo A. Even an underview, photo B, will not scare the constructor.



## BUILD THIS PRACTICAL F.M. ADAPTER

*Complete directions make it easy for any constructor to build and align this Frequency Modulation Adapter. Use it with any radio set or P.A. system. Add headphones and it functions as a complete F.M. receiver.*

ARTHUR H. LYNCH

**W**ITH the advent of Summer, the value of programs over the new frequency-modulated broadcasting stations will become more and more apparent. Our own investigation of this new field bears out the statements which have been made by the engineers of several of the large companies which now have frequency modulation receivers and frequency modulation adapters for use with regular broadcast receivers available.

The claim, of course, which seems most important with Summer and the thunderstorm season coming on, is that frequency-modulated broadcasts can be received through the most severe thunderstorm with no interference whatever.

Here's an interesting story that illustrates this feature, which Frank Gunther, the Chief Engineer of Radio Engineering Laboratories, the organization which has built most of the equipment for Major Armstrong, as well as for many other frequency modulation broadcast stations, told us that one day last Summer.

When a crowd of visitors had climbed the mountain to the location of the Yankee Network's station at Paxton, Mass., a very severe lightning storm came up. The children of the group were obviously frightened. The engineer in charge connected an extra, remote loudspeaker to the F.M. receiver used to pick up the transmissions of the relay station, which was sending onward to Paxton the program from Boston, and raised the output volume of the loudspeakers to a point where it overshadowed the thunder. While the storm was going on, the visitors enjoyed the music and paid little or no attention to the conditions outside, while previous to that time their attention was all on the outside.

### CONSTRUCTION

From the accompanying photographs and drawings it will be possible for the experienced constructor to duplicate the Frequency Modulation Adapter which we have built. By comparing the pic-

tures, the circuit diagram and the List of Parts, it should be a simple matter to identify the location of all the component parts. The construction and the circuit are entirely straightforward and adjustment of the completed receiver follows normal practice. It will be observed that a view of the receiver has been made from the bottom, so as to enable the constructor to see those parts which would otherwise be obscured by a portion of the cabinet.

Considerably better performance is provided where an 1852 (6AC7) tube is employed in place of the 6SK7 in the radio frequency stage. The improvement is found in much better gain and results in considerably better limiter action. Another 1852, (6AC7) may be used in place of 6SK7V4 as indicated in the circuit diagram but it is sometimes found that this changeover results in oscillation. In any event, it is worth a trial.

### ALIGNMENT

The materials needed for aligning the completed F.M. Adapter are a service oscillator and a 200-microamp. galvanometer. For aligning the discriminator, T4, a 0.1-meg. resistor must be inserted in series with the meter. With meter and series resistor connected across R23 apply a signal to control-grid of the 6SJ7. Using 2,100 kc. as the frequency of the I.F., and modulating with 400-cycle note, adjust the primary of T4 for maximum reading of the galvanometer.

The meter with its series resistor should now be connected to both cathodes of the 6H6. Apply an unmodulated signal to the control-grid of the 6SJ7 and adjust the secondary trimmer of T4 for zero reading on the galvanometer. Rock the oscillator back and forth 100 kc. each side of 2,100 kc. and note that the galvanometer should show an equal deflection either side of zero as the frequency is changed. There should be a change of voltage proportionate to the change in frequency either side of the "center" frequency.

Now remove the series resistor and insert a meter in series with R18 at the point marked X. Apply an unmodulated signal to the control-grid of V4. Set the oscillator to 2,150 kc. and adjust the



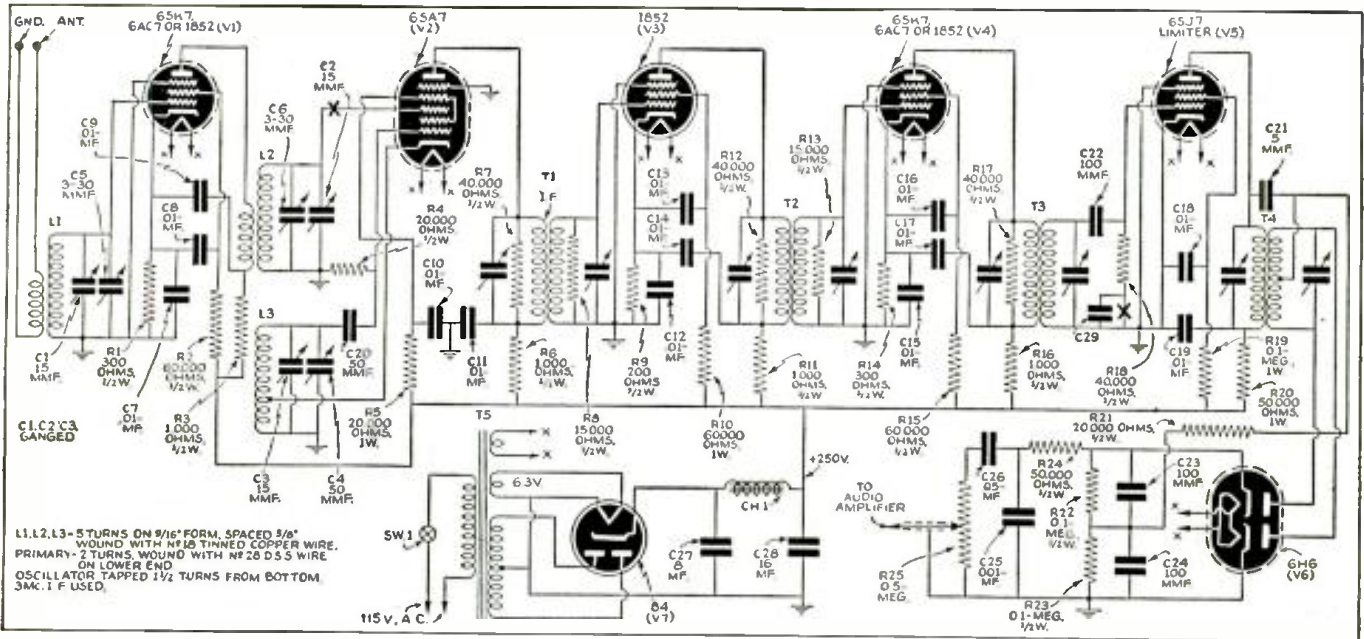

This F.M. Adapter may be used with headphones as a complete receiver; or it may be used to drive the A.F. section of any radio receiver or P.A. system.

primary trimmer of T3 for maximum deflection of the meter. Next set the oscillator to 2,050 kc. and adjust the secondary trimmer for maximum reading. The oscillator should now be rocked 100 kc. either side of 2,100 kc., and meter readings taken at various positions, to make sure the transformer shows a symmetrical resonance curve. It is not necessary that the transformer have a flat top (of 200 kc.) but that it should be symmetrical. It is desirable that the signal should attenuate rapidly beyond the 2,000 kc. and 2,200 kc. points.

Apply a signal to the control-grid of V3 and proceed as above.

Short the oscillator coil to V2, apply a signal to the control-grid of V2, and adjust T2 as before. Next disconnect the short on the oscillator coil and apply a modulated, 43-mc. signal to V2 and turn C4 until the meter in the control-grid circuit of V5 registers a reading. Now adjust trimmer C6 for maximum reading. Finally, apply a 43-mc. signal to the antenna terminal and adjust C5 to maximum. The band-width of R.F. is sufficient to pass the broad band.

When using a 6AC7/1852 in place of the 6SK7 more care must be taken in the placement of parts and in the laying of ground wires. Each circuit must be grounded at the socket to chassis and all points on the chassis connected together with 1/4-in. braid. It may be desirable to use braid to ground the shield of the tube as wire has a higher R.F. resistance.

It may be necessary to insert a 15- to 25-ohm resistor in series with the control-grid of V2, at point X, to suppress parasitic oscillation.

Coil construction: L1, L2, L3—5 turns, on 9/16-in. form, spaced 5/8-in. and wound with No. 18 tinned wire. Primary—2 turns wound with No. 28 D.S.S. on lower end. Oscillator tapped 1 1/2 turns from bottom. An I.F. of 2.1 mc. is used.

CREDITS

It was our purpose in providing this design to make the advantages of frequency modulation reception available to the more experienced constructor. It will be recognized that the receiver has been designed to use items which will be found in stock in most of the leading radio stores. The Serviceman should find this design extremely interesting because the construction of

such a unit will give him an insight into the operation of the receivers of this nature and will be very beneficial to him in handling service problems on the various F.M. sets now on the market. Connect a doublet antenna to terminals Ant. and Gnd.

The author desires to express appreciation for the assistance given him by Messrs. Shaughnessy, Day and Stiles, of Major Armstrong's laboratory.

The actual building of this receiver was done for the writer by Mr. Anton Schmitt, W2KWY, of the Harvey Radio Company of New York City; and the receiver has been thoroughly tested not only in the laboratory of the National Company at Malden, Mass., but also in the laboratory of Major Armstrong at Columbia University in New York City, and in the Radio Engineering Laboratories, Long Island City, N. Y.

LIST OF PARTS

CONDENSERS

- Three National Co., type UM-15, C1, C2, C3;
- One National Co., type UM-50, C4;
- Two National Co., type 3-30, C5, C6;
- Fourteen Cornell-Dubilier, type DT-6S1, 0.01-mf., 600 V., C7, to C19 (incl., C29);
- Two Cornell-Dubilier, type 5W-5Q5, 50 mmf., C20, C21 (erroneously indicated in diagram as 5 mmf.);

- Three Cornell-Dubilier, type 5W-5T1, 100 mmf., C22, C23, C24;
- One Cornell-Dubilier type, 1W-5D1, 0.001-mf., C25;
- One Cornell-Dubilier, type DT-4S1, 0.05-mf., 600 V., C26;
- One Cornell-Dubilier, type BR-845, 8 mf., 450 V., C27;
- One Cornell-Dubilier, type BR-1645, 16 mf., 450 V., C28;

RESISTORS

- Two I.R.C., type BT 1/2, 300 ohms, R1, R14;
- Four I.R.C., type BT 1/2, 1,000 ohms, R3, R6, R11, R16;
- Two I.R.C., type BT 1/2, 20,000 ohms, R4, R21;
- Four I.R.C., type BT 1/2, 40,000 ohms, R7, R12, R17, R18;
- Two I.R.C., type BT 1/2, 15,000 ohms, R8, R13;
- One I.R.C., type BT 1/2, 200 ohms, R9;
- Two I.R.C., type BT 1/2, 0.1-meg., R22, R23;
- One I.R.C., type BT 1/2, 50,000 ohms, R24;
- Three I.R.C., type BT1, 60,000 ohms, R2, R10, R15;
- One I.R.C., type BT1, 20,000 ohms, R5;
- One I.R.C., type BT1, 0.1-meg., R19;
- One I.R.C., type BT1, 50,000 ohms, R20;
- One I.R.C. potentiometer, type 13-133, 0.5-meg., R25;

TUBES

- One Sylvania or RCA 6SK7, or 1852 (see text), V1;
- One Sylvania or RCA 6SA7, V2;
- One Sylvania or RCA 1852 (see text), V3;
- One Sylvania or RCA 6SK7, or 1852 (see text), V4;
- One Sylvania or RCA 6SJ7, V5;
- One Sylvania or RCA 6116, V6;
- One Sylvania or RCA 84, V7;

MISCELLANEOUS

- Three National Co. I.F. transformers, T1, T2, T3;
- One National Co. discriminator transformer, T4;
- One United Transformer, A.F. transformer type R-54, T5;
- One Thordarson choke, Ch.1;
- One Hart & Hegeman roto switch, Sw. 1;
- One National Co. steel cabinet, type C5W-3 (the subpanel comes with this cabinet);
- One National Co. dial, type 0, with No. 2 scale;
- One National Co. dial drive, type ODD;
- Two National Co. knobs, type HRP.

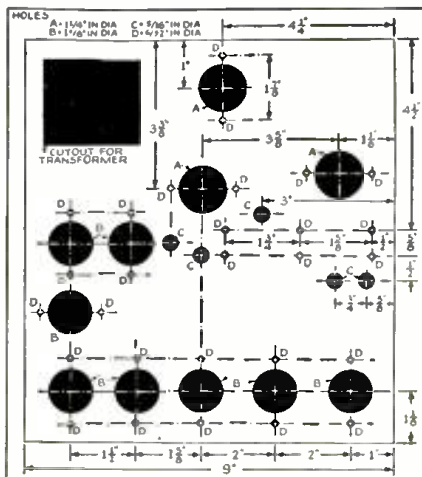

## RADIO DEVELOPMENTS

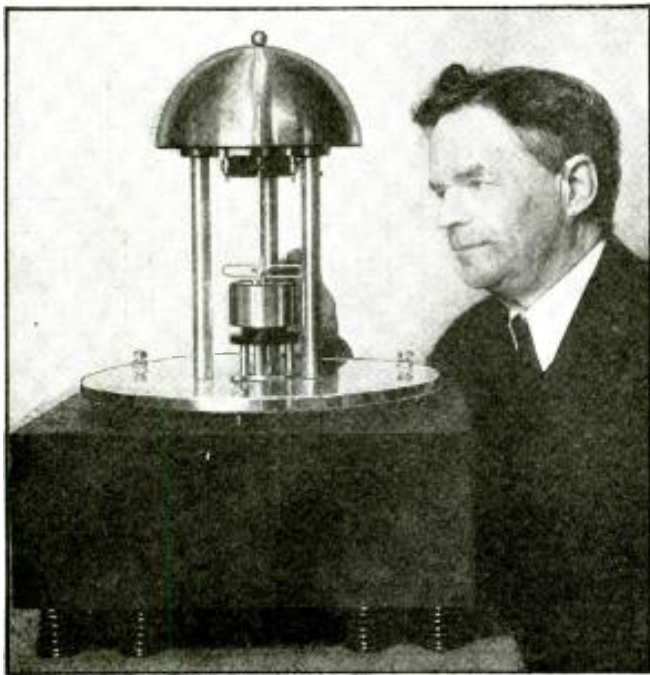

← The "singing-string" secondary time standard, and its originator Mr. Henry E. Wilson.

→ The voltage generated in a magnetic circuit by a vibrating alloy wire helps keep the wire humming.

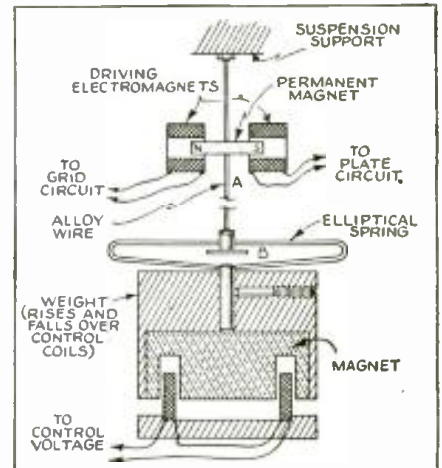

## AN A.F. CLOCK!

### *Musical Time Standard*

**C**LOCKS are "accurate" only to the extent that they remain exactly in step with some known frequency reference or "time standard." A time standard, remember, is the basis of our computations of the frequencies of radio channels, the speed of radio propagation, etc.

The earth revolving on its axis constitutes our primary or astronomical standard. Secondary standards include the *pendulum* (accurate to about 1 sec./yr.); the *vibrating quartz crystal* (accurate to about 1/6-sec./yr.); the *tuning fork* (accurate to about 1/10-sec./day); and, the new\* *singing string*, with an accuracy about equivalent to the *tuning fork*. Virtually a vibrating violin string, it sets up and maintains oscillations, in a vacuum-tube circuit, at a predetermined frequency.

The first consideration is the string. Under ordinary conditions it would be impossible to keep it in tune, as anyone familiar with string instruments will attest, but this problem was solved

by several expedients. A dual-wire string, consisting of a nickel-steel alloy and a beryllium-copper alloy, maintains uniform length, and hence frequency, with changing temperature. Any slight changes that remain are ironed-out by placing a light spring at the lower end to aid or oppose the gravity force exerted by a heavy weight (used for major tuning of the string). Coils which project into an alnico magnet set in the base of the weight, and which connect to a voltage source, establish a magnetic pull or push on the weight to further tune the string.

Now that we have a string capable of vibrating, it only remains to drive it. This is conveniently accomplished in somewhat the manner utilized in tuning-fork oscillators (†). In the case of the musical-string oscillator, a cobalt-steel bar-magnet is rigidly fastened to the center of the string. One pole projects into a pick-up coil connected to the grid of a triode, and the other, into a driver coil in the plate circuit of the same tube. The A.F. output, which is nearly sub-audible, is then amplified to any desired degree; 2 watts, for example, will run a Telechron clock motor.

\*See "A New Time Standard," by Henry E. Warren, Assoc. A.I.E.E. (Pres., Warren Telechron Co.); this paper was presented at a meeting of the A.I.E.E.

†See "Oscillators at Work," by John Rider.

## RADIO-CONTROLLED BOAT

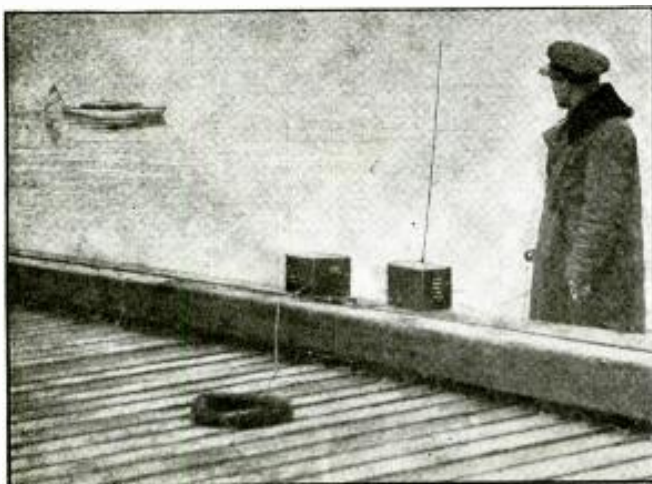

A "jam session" would not disturb the performance of the 6-ft. radio-controlled boat shown above. Due to its extreme selectivity, the ultra-shortwave receiver is practically immune to interference (jamming); however, any transmitter, knowing the combination, may pick up control and put the boat through its maneuvers at 5 m.p.h., up to a range of 11 miles, says its designer, Henry W. Wickes, a Lieutenant in the U. S. Naval Reserve, stationed at Floyd Bennett Field, Brooklyn, N. Y. Will the United States Navy take over this robot craft?

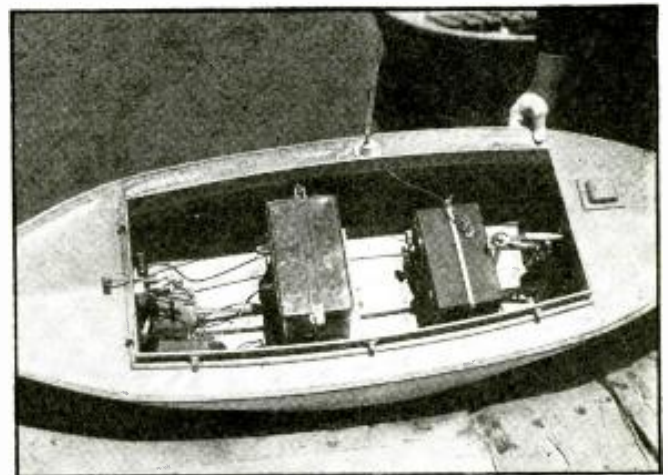

(Rudy Arnold Photos)

A flotilla of such radio-controlled boats, arranged to travel silently just below the surface of the water and each carrying a contact bomb in its snout, would seem to be a coastal defense weapon well worth developing—NOW. An airplane beyond effective range of anti-aircraft guns still could unerringly direct to its objective a torpedo-boat of this design. The 2nd photo shows the "works" in close-up. The receiver has a rod antenna. A storage battery powers set and boat for 3 hours.



# DUAL-COAXIAL SPEAKER

The Armstrong Wide-Swing Frequency Modulation System, which has made practical for the first time utilization of the full audible range in broadcasting, has created a desire by broadcasting stations for an exceptionally wide-range Monitor Speaker. To meet these requirements, the Dual Coaxial Loudspeaker, here described, was developed. The speaker, although essentially for F.M. Monitoring, too, is excellent for A.M. Monitoring.

THE model 35 Dual-Coaxial Monitor Speaker, here described, is probably the most recent attempt to solve in convenient, economical fashion, the problem of high-fidelity reproduction as afforded in "F.M." reception. This reproducer employs a new dual loudspeaker system which has an exceptionally wide frequency range. Both speaker units are of the direct-radiator cone type, the small, high-frequency speaker being mounted coaxially with the low-frequency speaker and within the hollow of its cone, the 2 thus closely simulating a unit source. A marked increase in naturalness is thereby attained over the reproduction afforded by the usual side-by-side arrangement having a comparable cross-over frequency. The cones of both loudspeakers are equipped with carpinchoe-leather edge supports to control diaphragm resonances.

The high-frequency radiator is only 2½ ins. in dia., providing not only desirably small mass but also wide-angle radiation over an extended frequency range.

## CROSS-OVER AND RESPONSE

It is caused to function adequately down to the cross-over frequency of 1,500 cycles by broadly resonating at an appropriate frequency the mass of the moving system with the stiffness of the air in a tight-back enclosure. This stiffness also serves as a protective feature in preventing acoustic driving of the high-frequency speaker by the adjacent low-frequency speaker.

The presence of the high-frequency speaker structure in front of the 8-in. low-frequency cone acts as a spreader for the radiation of the latter in its upper frequency range, where concentration around the axis otherwise would become effective. The back of the low-frequency cone works into an acoustical labyrinth, which effectively extends the low-frequency response, prevents resonance in the enclosing cabinet, and provides a suitable acoustic load for the diaphragm.

The response of this speaker is substantially uniform from 70 cycles to 10,000 cycles, and significant response is obtained below 65 cycles and above 15,000 cycles.

## COVERAGE

The angular distribution is exceptionally wide, the response at 6,000 cycles, for example, at an angle of 50 degrees to the axis being down only 3 db. from that on the axis. The apparent efficiency of the system is from 4 to 6 db. higher than that of the usual radio loudspeaker. The input impedance is 24 ohms and the power-handling capacity on speech and music is adequate for, as example, the largest home rooms.

The No. 35 monitor speaker is designed to handle the output of a 15-watt audio-frequency amplifier. However the apparent power output of the complete loudspeaker assembly (loudspeakers and baffle) will be greater than the apparent output of a single speaker and baffle assembly operated at the same power because of the increased frequency range made possible by the use of 2 loudspeakers arranged for wide frequency response. Although the frequency range required for voice reproduction ordinarily is considered to be quite narrow, this is true only for the fundamental voice frequencies; it is the harmonics which serve to set one voice apart from another and these harmonics may extend to quite high frequencies. Exceptional naturalness in voice reproduction therefore may be expected from a sound reproducing system such as the dual coaxial speaker having wide frequency response. This is actually the case. Add to this characteristic of voice realism the advantage of still wider frequency response in the reproduction of music together with the almost complete lack of background noise, in startling contrast with ordinary A.M. reception, which characterizes the performance of F.M. receivers and you have a new merchandising possibility.

In the No. 35 Monitor Speaker the apparatus complete with dividing network and field supply rectifiers is housed in an attractive modernistic cabinet finished in metallic beige lacquer with black trim. Height, 29¼ ins.; width, 27½ ins.; depth, 15½ ins.

This article has been prepared from data supplied by courtesy of Stromberg-Carlson Telephone Manufacturing Company.

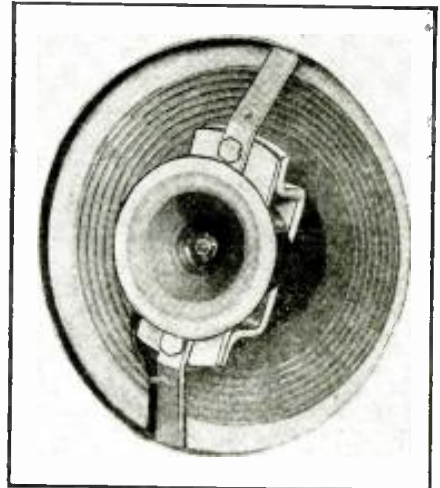

Front view of the Stromberg-Carlson No. 35 carpinchoe-leather Monitor Speaker in the new dual-coaxial design.

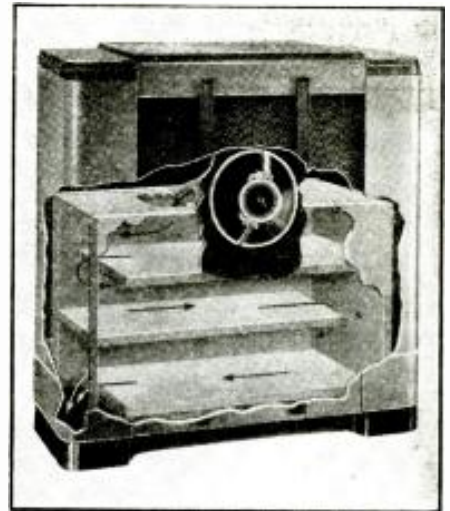

Cut-away view of the new No. 35 Monitor Speaker showing the location of the dual-coaxial speakers in relation to the patented labyrinth (to aid low-frequency reproduction) enclosed in the cabinet cavity.

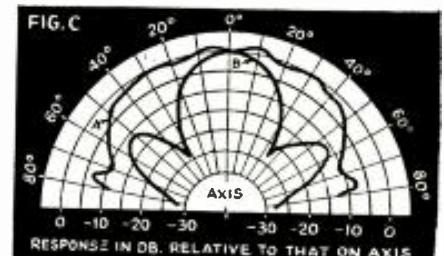

Directional characteristic of the Dual-Coaxial Loudspeaker (A) at 6,000 cycles compared with that of a single 8-in. cone speaker (B). Measurements made on 18-in. radius.

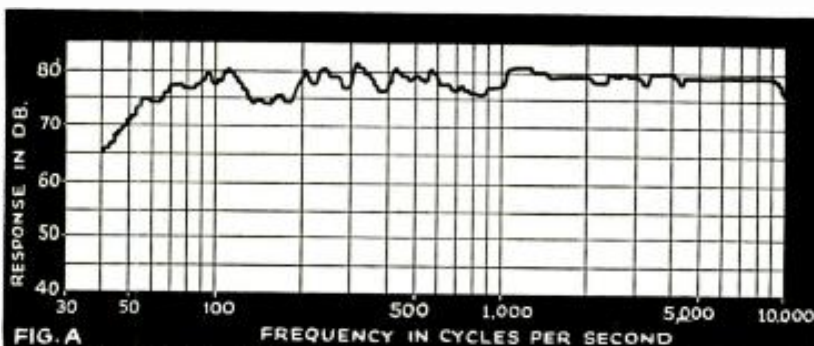

Response of the Dual-Coaxial Loudspeaker measured in a damped room at 10 ft. average distance, and with the microphone rotated on a 8-ft. radius.

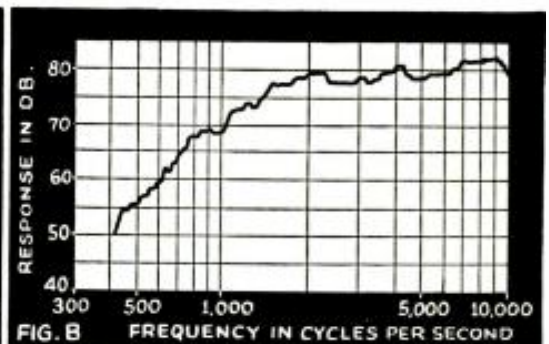

Response of only the high-frequency loudspeaker, of the No. 35 assembly, measured on axis at 18 ins. distance. (The 2-unit assembly handles 15-W.)



# • LATEST RADIO APPARATUS •

## HIGH-VOLTAGE WET ELECTROLYTICS

Aerovox Corp.  
New Bedford, Mass.



THESE units are available in 4, 8 and 16 mf. capacities, with a 600-V. D.C. surge rating as compared with 350 and 500 V. ratings heretofore available. Units are self-healing. Can sizes are 1 1/8 and 1 1/2 in. dia., and 3 7/16, 4 7/16 and 4 15/16 ins. high.

## ADJUSTABLE-LINK OSCILLATOR AND BUFFER COILS

Bud Radio, Inc.  
5205 Cedar Ave., Cleveland, Ohio



COILS are designed for use in circuits where it is desirable to adjust excitation or antenna loading by varying the link coupling. Each coil is individually linked and coupling is varied by pushing the link in or out of the main winding. All coils in this series fit

standard 5-prong sockets and are designed for stages where the input power does not exceed 50 W. Coils are available for all amateur bands.

## NEW MIKE STAND

Eastern Mike-Stand Co.  
56 Christopher Ave., Brooklyn, N. Y.

THIS new-type mike stand has a hollow base made of die-cast metal to which a highly polished chromium finish is applied instead of the usual method of using a thin metal shell around an iron casting. The edge of the base is fitted with a rubber link which acts as a base guard and shock absorber. The stand weighs 6 lbs. but its weight can be increased when desired by filling the hollow base with sand, buckshot, etc. Light to carry, it may be weighted "on location."

## NEW PHOTOELECTRIC CONTROL

United Cinephone Corp.  
43-37 33 St., Long Island City, N. Y.



THESE controls are housed in compact (9 x 6 1/2 x 4 1/4 ins.) enclosures having knock-outs in the bottom for power connections and a knockout on top for wiring-in external photocells. Various models are available, some with external photocells, others with collector lenses. All units utilize a type 6J5 amplifier tube; the photocell-tube life is about 10,000 hours.

Designed to operate on 110 V. A.C. line, 50 to 60 cycles. Also available in D.C. models.

## 30-W. AMPLIFIER WITH AUTOMATIC RECORD CHANGER

Allied Radio Corp.  
833 W. Jackson Blvd., Chicago, Ill.



THIS unit features an RCA record changer which operates from 6 V. D.C. or 110 V. A.C. Features of the amplifier are 37 W. undistorted (37 W. peak), output impedances of 2, 4, 6, 8, 16 and 500 ohms available on a selector switch. Four input channels, namely, 2 for use with high-impedance mikes (each with individual volume controls), 2 for phono inputs with wider control; 2 tone controls of the attenuator type, 1 for treble and 1 for bass. The gain for microphone is 135 db., and phono, 80 db. Frequency response is 30 to 12,000 cycles per second (for the amplifier). Standby switch helps reduce power consumption.

## 3-TUBE SMALL-SIZE HEARING-AID

TayBarn Equipment Co., Inc.  
135 Liberty St., New York, N. Y.



KNOWN as the "Ultra-Ear" this compact hearing-aid is easily concealed on both men and women. Although measuring but 4 1/2 ins. long, 2 1/4 ins. wide and 15/16-in. thick, it incorporates a 3-tube high-gain audio amplifier and crystal microphone; this design assures adequate sensitivity, fidelity and volume.

Sensitivity is said to be sufficient for normal conversation up to 30 feet. Its frequency response is so designed as to benefit 80 per cent of the hard-of-hearing cases. Power output better than 50 milliwatts (ample for properly actuating not only

earphones but also all bone conductors). Small-size "A" cell and 30-V. "B" battery are in a separate, compact case.—Radio-Craft

## NEW RELAYS

Standard Electrical Products Co.  
317 Sibley St., St. Paul, Minn.

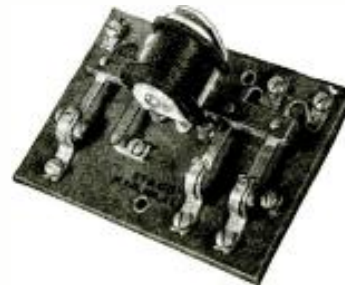

ILLUSTRATED is one of a series of new relays designed especially for radio frequency and high-voltage applications. Types BBA (for use up to 15 mc.) and BMA (for use up to 60 mc.), illustrated, are the break-in type known more commonly as the push-to-talk relays. The amateur radio operator merely presses a pushbutton while transmitting and releases it when receiving. The relay has 4-ampere, 3/16-in. pure silver contacts. Available with 110 V. A.C. or 6 V. D.C. coils. Insulation is Mycalex, on type BMA. Other types of relays are available for intercommunication units, remote-control circuits, and antenna change-over.

## THIN-CASE PORTABLE

Philco Radio & Television Corp.  
Tioga & C Sts., Philadelphia, Pa.



ILLUSTRATED is one of a new line of Philco 1941 portables. It is model 81-T having self-contained batteries. Other features include 4 tubes, built-in loop antenna, lightweight full-vision dial and slender case.

## VARIABLE CRYSTAL OSCILLATOR

Bliley Electric Co.  
Union Station Bldg., Erie, Pa.



THIS "Vari-X" instrument is a variable frequency exciter with self-excited oscillator which affords excellent frequency flexibility with full quartz crystal stability flexibility for the amateur's transmitter. Its power output is 2 1/2 W. at either 40 or 80 meters. It is worked from the station operating position and is easily installed. Pentode, tetrode and low-power triode tubes customarily employed in the normal oscillator



stage will be easily driven as an amplifier by the Vari-X. Either one of the 2 crystal units plugged into the socket on the Vari-X panel is instantly chosen by a convenient selector switch. Total adjustable frequency range at 80 meters, about 12 kc.; frequency doubling (40 meters), about 24 kc.; quadrupling (20 meters), about 48 kc. Metal cabinet is 8 ins. sq.

**RADIO NOISE METER**

RCA Mfg. Co., Inc.  
Camden, N. J.

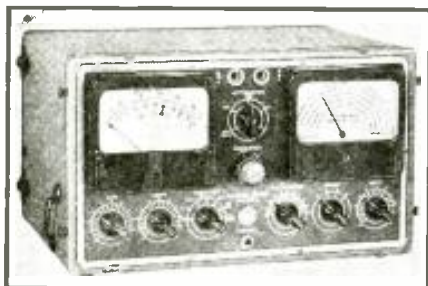

**TYPE 312.** Built around a superhet. receiver. Its principal uses include measuring the noise levels of transmission lines and electrical apparatus, and field strength of radio signals in comparison with noise levels. When equipped with a directive loop antenna it indicates the direction of signals and interfering noises. Size, 13 3/4 ins. high, 13 3/4 ins. wide and 9 1/4 ins. deep.—Radio-Craft

**NEWEST 3-WAY PORTABLE**

Allied Radio Corp.  
833 W. Jackson Blvd.  
Chicago, Ill.



**NEWEST** portable radio set merchandised by this company incorporates automatic change-over from battery to electric (A.C.-D.C.) operation, and vice-versa. Tuning range, 540-1,550 kc.; has 5 tubes, A.V.C., and sliderule dial; wgt., 15 lbs.—Radio-Craft

**NEW CONE LOUDSPEAKER**

RCA Mfg. Co., Inc.  
Camden, N. J.



**MODEL MI-6233.** A new P.M. dynamic loudspeaker which makes effective use of a folded or "accordion edge" cone support principle. This permits the cone to move more freely when driven by the permanent-magnet speaker mechanism. It is

claimed to reproduce low frequencies with a fidelity never before obtainable with a small speaker in a small cabinet. Its frequency response is from 80 to 7,000 cycles. Its diameter, 7 ins.; weight, 3 lbs. Handles 3 W. continuously.—Radio-Craft

**PORTABLE RECORDING STUDIO**

Speak-O-Phone Recording & Equipment Co.  
23 W. 60th St.  
New York, N. Y.

**NOW** available is a complete Recording Studio incorporating a collapsible booth and recording equipment. Booth measures 57 x 30 x 78 ins. high; easily assembled; soundproof; accommodates 2 persons in recording section; has 2-way interphone between customer and technician; easily carried by car. Has built-in P.A. system for ballyhoo. Comes wired complete with lights and recording equipment.—Radio-Craft

**MULTITESTER MODEL 414**

Radio City Products Co.  
88 Park Pl., New York, N. Y.



**MODEL 414** Universal Deluxe Multitester is now available in 4 additional series. Series V7 has a large 7 1/4 in. bakelite square meter, jewel indicating light, and front-panel fuse holder. Series V9 is the same except that meter is 9-in. jumbo round type. Series RP7 is similar to V7 except that the panel is arranged horizontally for rack mounting and has no case; meter is instantly removable for use at a remote point. Series RP9 is identical to series RP7 with the exception of the meter which is a 9-in. round type.

**FLUORESCENT-LAMP CONDENSERS**

Cornell-Dubilier Electric Corp.  
S. Plainfield, N. J.

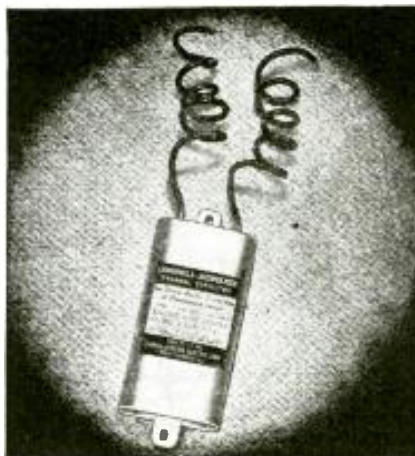

**DESIGNED** especially for power factor correction which is necessary when using the new fluorescent lamps. "Dykanol"

impregnated. Three general types—KF, KS, KW—available to fit all standard wiring channels and in capacity values to satisfy the power factor correction requirements of any installation.

**MIDGET PLUG-IN-SHAFT POTENTIOMETERS**

International Resistance Co.  
401 N. Broad St., Philadelphia, Pa.

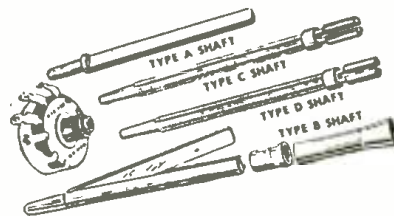

**MANUFACTURER** recommends these for universal use in volume control replacements. Installation is simplified through the use of plug-in type shafts making a small stock of these units handle a large variety of receivers.

**RUNS PHONOS ON D.C.**

American Television & Radio Co.  
300 E. 4th St., St. Paul, Minn.

**MODELS PCP, -F,** and -R Phonograph Inverter permits the operation of 110-V. A.C. phono motors on 110-V. D.C. Used primarily in phono-radio combinations and portables of the A.C.-D.C. variety. A good item for Servicemen to sell to owners of A.C.-D.C. sets. Size, 2 1/2 x 2 1/2 x 2 5/16 ins.; weight, less than 1 lb.—Radio-Craft



**3-UNIT ANALYZER KIT-SET**

Simpson Electric Co.  
5216 W. Kinzie St., Chicago, Ill.



**COMPRISES** 3 small matched meters, in a single carrying case, per kit; 3 different kits (9 meters) are available. The meters are available in combinations to measure current, voltage and resistance for all requirements. This grouping of individual meters it is claimed increases flexibility, reduces cost and makes readings easier. All meters may be used separately. Each meter is the same (uniform) size, 5 1/4 ins. x 2 3/8 ins. x 1 1/4 ins. and none weighs more than 20 ozs.—Radio-Craft

# • LATEST RADIO APPARATUS •

**FREE -  
REAL  
ELECTROPLATING  
OUTFIT**



**Now -  
You Can ELECTROPLATE  
EASILY WITH A BRUSH**

**S**OMETHING new for radio men—something which gives you the opportunity to make additional profits—or to improve your type of service. Here's an **ELECTROPLATING KIT** amazingly simple to operate—you just Electroplate with a Brush!

## NOT A TOY!

Electroplate for profit, hundreds of things in the household—ashtrays, fixtures, water faucets, worn brackets, door knobs, musical instruments, jewelry and silverware and other articles. It's an indispensable piece of equipment—Dip articles in hot solutions, apartments, office buildings, medical and dental offices, factories, schools, laboratories, etc. Exactly the same outfit (but larger) is used professionally by electricians, radio service men, automobile repair shops, etc. Requires one single dry cell 1½-volt battery to operate.

You can electroplate tarnished receiver parts, escutcheons, contacts, worn radio parts and accessories, and display chassis. Put this **REAL ELEC-TROPLATING KIT** to use immediately—make it the most useful article in your shop or laboratory. And you can get it absolutely **FREE** (except for slight mailing cost).

Subscribe today to **RADIO-CRAFT** for One Year (12 issues) and receive absolutely **FREE** this **ELEC-TROPLATING KIT**. New subscribers are accepted or extend your present subscription twelve months. Mail remittance of \$2.00 (plus 10¢ for shipping charge on kit) to the publishers. (Canada and foreign \$2.85). You will receive your **FREE, REAL ELECTROPLATING OUTFIT** by return mail. Use coupon below to enter subscription.

## RADIO-CRAFT

20 Vesey Street New York, N. Y.

RADIO-CRAFT RC-840  
20 Vesey Street, New York, N. Y.

Gentlemen: Enclosed find my remittance of \$2.00 for which enter my subscription to **RADIO-CRAFT** for One Year (12 issues). Send me **FREE, ELEC-TROPLATING OUTFIT** (Canada and foreign \$2.85) in U. S. add only 10¢ additional to cover shipping charges on kit.

New Subscriber  Extend Present Subscription

Name .....

Address .....

City ..... State .....

(Send remittance by check, money order or un-used U. S. Postage stamps. Register letter if you send cash or stamps.)

## NEW OSCILLOSCOPE

Allen B. Du Mont Labs., Inc.  
2 Main Ave., Passaic, N. J.

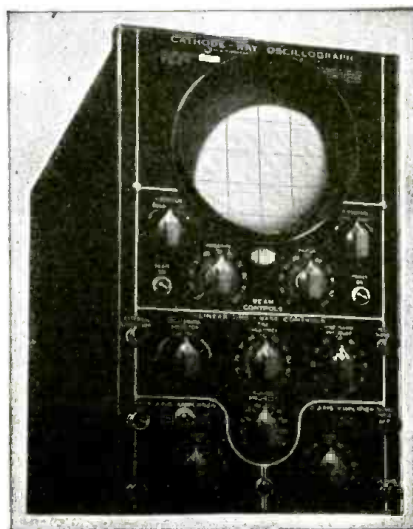

**T**YPE 208. Designed with sufficient flexibility, associated circuits and controls to facilitate its application to the great majority of laboratory requirements. Utilizes an intensifier-type cathode-ray tube with electrostatic focusing and orthogonal electrodynamic deflection. Its amplifiers are flat to 100,000 sinusoidal cycles per second. Its sweep frequency range is 2 to 50,000 cycles per second. These response ratings are entirely independent of attenuator settings. Incorporates many other new features.—*Radio-Craft*

## NEW SOUND PROJECTORS

Jensen Radio Mfg. Co.  
6601 S. Laramie Ave., Chicago, Ill.

**T**YPE "S" peri-dynamic projector. Employs a heavy-duty P.M. speaker capable of handling 15 to 25 W. of input power. The speaker is sealed within an enclosure and utilizes the peri-dynamic principle, resulting in a sharp improvement in the middle frequency response. Lack of radiation from the back of projector helps eliminate feedback troubles.—*Radio-Craft*

## "RADIORECORDER"

Radio Wire Television, Inc.  
100 Sixth Ave., New York, N. Y.

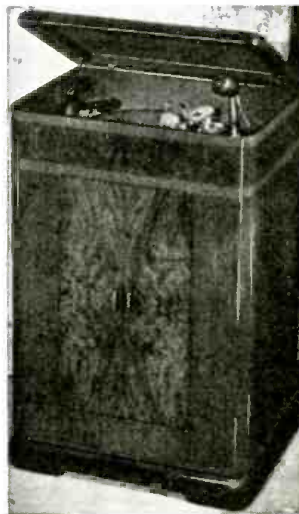

**L**AFAYETTE model BB-96. A combination which includes a high-fidelity radio, recorder and playback equipment. The

radio set is a 12-tube, 3-band chassis, including 6-button station selection, built-in broadcast and shortwave loop antennas, tuning indicator. Recordings may be made of radio programs and local talent via a microphone. Entire combination may also be used as a public-address system.—*Radio-Craft*

## 10-W. AMPLIFIER

Terminal Radio Corp.  
68 W. 45 St., New York, N. Y.



**M**ODEL T-8. A neat 8- to 10-W. amplifier for public-address work or for use in homes with good record players and frequency modulation tuners. Has 2 high-impedance input channels for microphone and record player, and provides for compact mixing and fading operations.—*Radio-Craft*

## BX CUTTER

Ideal Commutator Dresser Co.  
3067 Park Ave.  
Sycamore, Ill.



**T**HE time- and labor-saving BX Armor Cutter here illustrated has jaws that fit BX cable of any make, and 2- or 3-wire No. 12 or No. 14. Cutting blade is removable. Does not nick wire. Eliminates waste.—*Radio-Craft*

## "CHEST MIKE"

Universal Microphone Co.  
Inglewood, Calif.

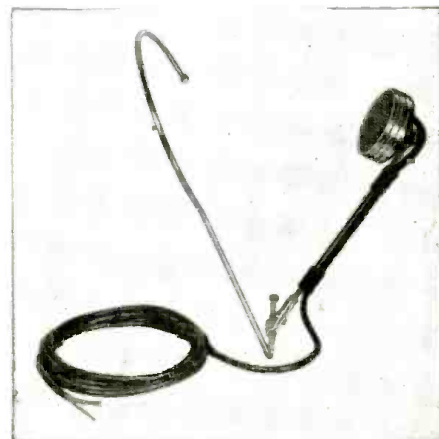

**C**LOSELY resembles the breastplate arrangement used by telephone operators.



Enables the operator to have both hands free. Adapted for sound trucks, mobile transmitters, etc. Its frequency response is ample for all usual requirements; the output is 48 db. below 1 V. per bar. Known as model N-3. Weighs less than ½-lb.—*Radio-Craft*

**F.M.-A.M. MASTER ANTENNA**

Technical Appliance Corp.  
17 E. 16 St., New York, N. Y.

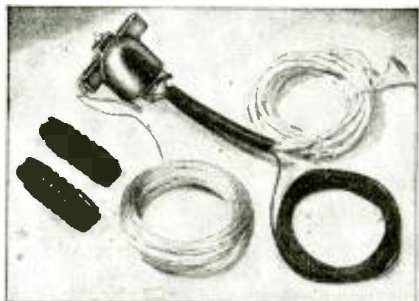

**A**LTHOUGH usable for A.M. receivers, this system provides for an expanded frequency range to include F.M. reception. The use of iron-dust cores permits full isolation of primary and secondary transformer windings without loss in signal strength; 15 to 25 receiver coupler units may be fed from 1 master antenna.—*Radio-Craft*

**NEW SQUARE METER**

Burton-Rogers Co.  
857 Boylston St., Boston, Mass.



**T**YPE 600. A 4½-in. square molded case meter which provides for illumination if desired. The face is open, the corners are rounded. Circular back is 2¾ ins. in dia., 1 1/16 ins. deep. The movement has an accuracy of 2 per cent; sensitivity 42 mc. at 1 ma. Scale is 3½ ins. long.—*Radio-Craft*

**DELUXE "TEL-OHMIKE"**

Sprague Products Co.  
North Adams, Mass.

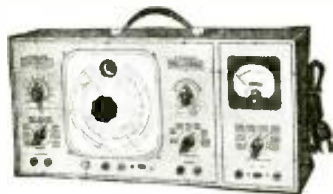

**T**HE instrument includes a built-in volt-meter and milliammeter with switch and pin-jacks for external measurements. Meter ranges, selected through an 8-position switch, are 15, 150, 500, 1,500 V., D.C.; and, 1.5, 15 and 50 ma., D.C. The instrument tests all condensers and resistors, and indicates "intermittent-open" condensers and resistors. Balance is indicated on an "eye" tube.—*Radio-Craft*

**"BREAK-IN" SWITCH**

Atlas Sound Corp.  
1447 39 St., Brooklyn, N. Y.



**T**HIS switch offers in a single unit both "on-off" and press-to-talk operation. The button is pressed to talk; and turned, to shut off the mike. Designed to modernize mikes which do not have close-at-hand switches.—*Radio-Craft*

**POCKET MULTIMETER**

Supreme Instruments Corp.  
Greenwood, Miss.



**M**ODEL 543. A small-size pocket multimeter using a 3-in., 1-ma. meter. Single rotary selector switch provides functions and ranges of: Resistance—0/2,000/200,000 ohms; D.C.—0/6/60/600 ma.; A.C.—0/15/150/600/3,000 V.; D.C.—0/15/150/600/3,000 V. Batteries are self-contained. Ranges at 1,000 ohms/volt (standard) sensitivity.—*Radio-Craft*

**DOUBLE-TUNED I.F. TRANSFORMERS**

Radex Corp.  
1733 Milwaukee Ave., Chicago, Ill.



**T**HESE units duplicate electrically I.F. transformers used in the majority of receivers. Provisions are made to bring the

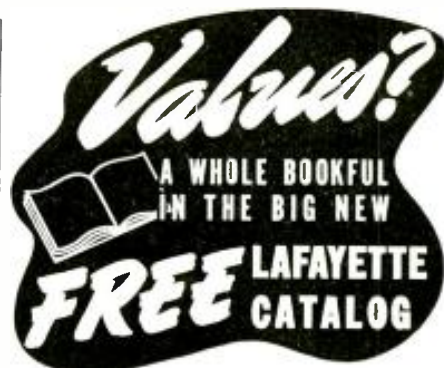

**MYSTERY Oscillator**  
with hand microphone

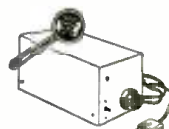

Now — enjoy your record player through your radio without a wired connection! Simply plug in output of crystal pick-up to the oscillator.

This "broadcast" to the radio which picks up and reproduces the music with all its original tone and brilliance. To conduct a "broadcast" of your own, connect to oscillator the hand mike offered with the complete unit. For 110 volts AC and DC. Complete with tube (12A7) and handmike at this special low price **\$2.95**

**Complete Battery Kits for Popular Portable Radios**



Exact duplicate replacement battery kits for the most popular portable battery radio sets on the market today. Replace the originals exactly; both physically and electrically. Offered at new low prices!

You save on every purchase. Shpg. wt., each kit, 7 lbs.

K20173—KIT "A" SALE PRICE **\$2.15**

K20174—KIT "B" SALE PRICE **\$2.49**

K20175—KIT "C" SALE PRICE **\$1.75**

K20176—KIT "D" SALE PRICE **\$1.75**

ANY ABOVE, SALE PRICE EACH **\$2.49**

K20177—KIT "E" SALE PRICE **\$1.75**

**KIT "A" FOR FOLLOWING SETS:**

Emerson CE259; Philco 39, 71T, 72T, 74, 504; Pilot TH11, TH12; RCA 94BP80, 94BT1, 94BP4, 94BP64, 94BP1, 96GA, 94BP66; Zenith 4K400D, L, M, S, Y, 5416.

**KIT "B" FOR FOLLOWING SETS:**

Emerson C263, CT275, CX263, CX283, CX284, CX305, DC308, CE265, CE275; Pilot H11, H12; General Electric GB400, HB408.

**KIT "C" FOR FOLLOWING SETS:**

General Electric JB515, JB508, HB412; Pilot T1351, T1451, T1452, X1451, X1452; RCA BP55, 56, 85.

**KIT "D" FOR FOLLOWING SETS:**

Emerson DF306, DF302, DJ310, DJ311, DJ312, EA338, EA339, EA340, EA357.

**KIT "E" FOR FOLLOWING SET:**

Majestic 130.

**BUY BY MAIL OR IN PERSON**

At one of our 7 convenient stores. Either way you're sure to get better service—greater value.

100 Sixth Ave., New York, N. Y. • 901 W. Jackson Blvd., Chicago, Ill. • 265 Peachtree St., Atlanta, Ga. • 110 Federal St., Boston, Mass. • 24 Central Ave., Newark, N. J. • 542 E. Fordham Rd., Bronx, N. Y. • 90-08 166th St., Jamaica, L. I.



DEPT. 3H-100 SIXTH AVE., NEW YORK, N. Y.

I ENCLOSE \$ RUSH ATTACHED ORDER

PLEASE RUSH NEW FREE CATALOG No. 80

NAME .....

ADDRESS .....

CITY ..... STATE .....



# • LATEST RADIO APPARATUS •

## OPPORTUNITY AD-LETS

Advertisements in this section cost 15 cents a word for each insertion. Name, address and initials must be included at the above rate. Cash should accompany all classified advertisements unless placed by an accredited advertising agency. No advertisement for less than ten words accepted. Ten percent discount for six issues, twenty percent for twelve issues. Objectionable or misleading advertisements not accepted. Advertisements for August, 1940, issue must reach us not later than June 7th.

Radio-Craft • 20 Vesey St. • New York, N. Y.

### AGENTS WANTED

**300% PROFIT SELLING GOLD LEAF LETTERS FOR store windows; Free samples. Metallic Company, 431 North Clark, Chicago.**

### AMPLIFIER DIAGRAMS

**10 MODERN CIRCUITS OF 8 TO 64 WATT EASY-to-build high-fidelity amplifiers. All for 20c. Send coin or stamps. Amplifier Company of America, 17 West 20th Street, New York City, N. Y.**

### BOOKS AND MAGAZINES

**ASSURE YOURSELF OF GREATER PROFITS BY doing radio service jobs more quickly. Authentic service guides show you the way to locate and correct troubles in any radio receiver. Gernsback Official Radio Service Manuals show you how to complete more repair jobs in less time—how to earn more money by faster servicin. Read the advertisement which appears on page 120 of this issue.**

**WE HAVE A FEW HUNDRED RADIO ENCYCLO-pedias, by S. Gernsback, second edition, originally sold at \$3.98. Book has 352 pages, weight 3 lbs., size 9 x 12 inches. Red morocco—keratol flexible binding. Send \$2.49 in stamps, cash or money order and book will be forwarded orders collect. Technifax, 1915 So. State Street, Chicago, Illinois.**

### BUSINESS OPPORTUNITIES

**AMBITIOUS? EXTRA MONEY SHOWING TALKIES—home or neighborhood business—no investment—sound equip-ment. Films rented reasonably \$100-\$300 monthly possible—wonderful opportunity. 512 State Theatre Building, Pittsburgh, Pennsylvania.**

### EDUCATIONAL COURSES

**USED CORRESPONDENCE COURSES AND EDUCA-tional books bought, sold, rented, exchanged, catalog free. V. W. Vernon, Hensgar, Alabama.**

**CORRESPONDENCE COURSES AND EDUCATIONAL books, slightly used. Sold, Rented, Exchanged. All sub-jects. Satisfaction guaranteed. Cash paid for used courses. Complete details and bargain catalog FREE. Write Nelson Company, 500 Sherman, Dept. H-242, Chicago.**

### ELECTRICAL SUPPLIES

**FLOUORESCENT AC DAYLIGHT LIGHTING FOR desk; office; windows; home. Latest sensation. 50% dis-count. Literature FREE. McGee Radio, F-2053, Kansas City, Mo.**

### MANUSCRIPTS WANTED

**WANTED—MANUSCRIPTS, POEMS, SONGS FOR publication. Fortune's, 87 Fifth Ave., New York.**

### PRINTING

**125-8 1/2 x 11 BOND LETTERHEADS AND 125-6 1/2 envelopes, \$1.00 postpaid. Letterheads, envelopes, state-ments; 300—\$1.00. Bennelville, 907 West Roosevelt, Phila-delphia.**

### RADIO

**WE BUY AND SELL USED RADIOD TESTING EQUIP-ment. Time payments if desired. Harold Davis, Inc., Jackson, Miss.**

**DO YOU WANT A GOOD CAR-RADIO SET? HERE'S a chance to get an Arvin, List, about \$80; sell for \$25. Push-pull output affords high quality and power; set is selective and very sensitive. R. Bernard, 40 Manning Ave., No. Plainfield, N. J.**

**ATTENTION DEALERS, SELL WRIGHT SPEAKERS, WARD-LEONARD relays, rest-tors, CONSOLIDATED VOLUME CONTROLS, SUPREME INSTRUMENTS, Illinois CONDENSERS, Gernsback, Manuals, Sentinel Radios. Send for catalog. Anchor Radio Distribut-ing, Bryden Rd., Ithaca, New York.**

**HARD-TO-GET RADIOD DIAGRAMS. TRY USAL sources first. If you can't get them, try us. Price, 75c to \$1.50 if we succeed; no charge if we don't. You lose nothing! Send no money—write first giving fullest information. Enclose return-addressed, stamped envelope. We have helped many Servicemen, experimenters and radio fans. We may help you. Allan Stuart, P.O. Box 56, Teaneck, N. J.**

### STAMPS

**THREE SCARCE SETS, NOW OBSOLETE. 25c. WITH new customer. Gift: Box 211, Malden, Mass.**

### TECHNICAL ART SERVICE

**DRAFTING AND ART SERVICE—A COMPLETE Service for the Industrial and Commercial Marketers. If your business or plant can't afford a designing or drafting staff, don't let this stop you from going ahead with that new product you intend marketing, or that catalog of mechanical or electrical items which needs fine detailed drawings and highly retouched photographs. Any mechanical, electrical or radio problem can be solved for you by our associated staff of designers, draftsmen and artists, and technical copywriters. Write for any additional information as to methods and price for this service. Tec-Art Drafting Service, 224 Charlotte Terrace, Roselle Park, N. J.**

**SCHEMATIC DIAGRAMS-DRAFTING—SEND US A rough sketch of your circuit. Estimates by return mail. Our prices are moderate; our work guaranteed. No jobs too big or small. Wm. Kadleeck, Jr., 440 East 85th St., New York, N. Y.**

gridleak out from either the bottom or top of the shield can. The unit may be mounted either by the top or bottom of the can. Only 3 different units are required to cover practically all intermediate frequencies. Type A has a range of 150 to 250 kc.; type B, 240 to 300 kc.; type C, 430 to 500 kc.—*Radio-Craft*

## PORTABLE RADIO BATTERIES

Bright Star Battery Co.  
Clifton, N. J.

**S**EVEN new types of portable "A" and "B" batteries are added to this company's line which now comprises 4 types of 45-V. "B" batteries and the following "A" cells and batteries: 6 types of 1 1/2 V., 1 type, 4 1/2 V.; 4 types of 6 V. and 1 type of 7 1/2 V.—providing replacements for a good percentage of portable radio receivers.—*Radio-Craft*



**P**ERMITS electrolytic to be instantly re-moved without tools or trouble, for test-ing and replacement. Now used extensively by the U.S. Signal Corps and for aircraft police radio and sound system equipment where continuity of service is important. Available in etched foil and plain foil, in 2 can diameters, 1-3/8 and 1-5/32 ins., and in heights from 2 1/4 to 4 1/4 ins.—*Radio-Craft*

## DYNAMIC CUTTING HEAD

Sound Apparatus Co.  
150 W. 46 St., New York, N. Y.

**D**ESPITE its small size of 1 x 1 1/2 x 2 ins. and its light weight of 7 ozs., this cutting head, designed on the dynamic principle, has comparatively high efficiency (1-W. driving). Its damping is obtained entirely by air which results in extended frequency range which is claimed to be 9,000 cycles. Its impedance is 6 ohms and can be readily connected to any loudspeaker (low-impedance output). The impedance does not vary with frequency which is said to eliminate matching problems.—*Radio-Craft*

## "FLOCKING" REPAIR KIT

Stromberg-Carlson Telephone Mfg. Co.  
Rochester, N. Y.

**"F**LOCK" is the fuzzy, suede-like finish used on many phono turntables and in Stromberg-Carlson receivers (in the interiors of cabinets), partly to act as a finish and partly to help absorb the noise that comes directly from the needle. This kit ("flocking" gun, jar of binder, brush, a supply of green and brown flock, and instructions) is designed for the repair of damaged or worn "flock". It is known as No. SD-210.—*Radio-Craft*

## VIBRATOR POWER SUPPLY FOR PORTABLES

Electro Products Labs.  
549 W. Randolph St., Chicago, Ill.



**T**HE Synchro model Q (model R, for 2-V. sets) "A-B" power supply operates from any 6-V. D.C. power source (drain, 0.75-A.). Supplies "A" and "B" voltages to 1 1/2-V. receivers of 4, 5 and 6 tubes—without circuit changes. Measures 5 1/2 x 5 x 2 3/4 ins. Separate plug-in sockets provide correct filament voltages for the receivers; 90 V. of "B" at 18 milliamperes are provided.—*Radio-Craft*

## PLUG-IN ELECTROLYTICS

Aerovox Corp.  
New Bedford, Mass.



**P**ERMITS electrolytic to be instantly re-moved without tools or trouble, for test-ing and replacement. Now used extensively by the U.S. Signal Corps and for aircraft police radio and sound system equipment where continuity of service is important. Available in etched foil and plain foil, in 2 can diameters, 1-3/8 and 1-5/32 ins., and in heights from 2 1/4 to 4 1/4 ins.—*Radio-Craft*

## NON-INDUCTIVE RESISTORS

Clarostat Mfg. Co., Inc.  
285 N. Sixth St., Brooklyn, N. Y.



**S**ERIES Z. These are wire-wound units—necessary in many special applications—available in the following values: 10 W., maximum resistance 3,000 ohms; 25 W., 7,500 ohms; 50 W., 12,500 ohms; 100 W., 25,000 ohms. For 1/2 these power ratings multiply the maximum resistance available by 4.—*Radio-Craft*

## POWER TAP SWITCHES

Ohmite Mfg. Co.  
4835 Flournoy St., Chicago, Ill.

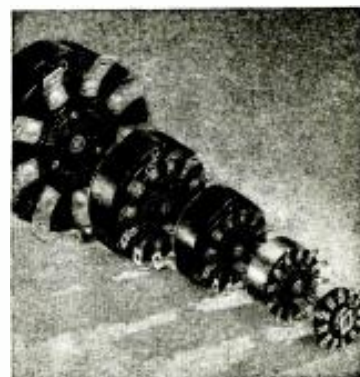

**H**IGHER ratings have been set for each of the 5 high-current tap switches recently announced. Model 111 is rated at 10 A., 150 V. A.C.; model 212 at 15 A., 150 V.



A.C.; model 312, 25 A., 300 V. A.C.; model 412, 50 A., 300 V. A.C.; model 608, 100 A., 300 V. A.C. These ratings apply to A.C. circuits operating at any power factor. Units are single-pole rotary selectors, multi-point, load-break, and non-shorting.—Radio-Craft

**"B"-BATTERY-LESS  
"4-WAY" PORTABLE**

Setchell Carlson, Inc.  
2233 University Place, St. Paul, Minn.



A PORTABLE radio receiver, model 66, which operates from (1) a self-contained "A" battery (as a portable on outings, etc.); (2) 110 V., A.C. (home or cottage); (3) 110 V., D.C. (office or hotel); or (4) 6 to 8 V., D.C. (car or boat). No "B" batteries of any kind are used; vibrator unit furnishes "B" power from the "A" supply.—Radio-Craft

**WIND-UP AUTO ANTENNA**

Radiart Corp.  
Shaw Ave., at East 133 St., Cleveland, Ohio

KNOWN as the Ro-Tenna this auto-radio antenna is a mechanical wind-up aerial which is controlled entirely from inside the car. A handy knob raises or lowers the aerial to the exact height desired for peak reception or for clearing overhead obstacles.—Radio-Craft

**5-10 METER CONVERTER**

Browning Laboratories, Inc.  
750 Main St., Winchester, Mass.

MODEL BL-510. A compact 5-10 meter converter for receiving 2 bands of frequencies when used in conjunction with any mobile, home, or aviation receiver; 4 separate low-loss tuned cir-



uits result in exceptional performance.—Radio-Craft

**MARINE RADIO TELEPHONE**

Jefferson-Travis Radio Mfg. Corp.  
198 Milburn Ave., Baldwin, N. Y.

"UTILITY" model 80. A crystal-controlled 5 to 7 W. marine radio telephone for use on all types of small sail and power boats. Designed for short-range service on a single, fixed-frequency channel such as ship-to-ship. Normal range, 25 miles. Consists of a radio transmitter, receiver, power pack, loudspeaker and microphone.—Radio-Craft



**CUTTING NEEDLES**

Recoton Corp.  
178 Prince St., New York, N. Y.

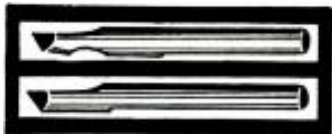

MADE of Swedish steel alloy, and diamond-dust polished to a perfect cutting edge, these needles give exceptionally quiet performance. Each needle has a flat portion on the shank, making it impossible to insert it at the wrong angle.—Radio-Craft

**NEW ACORN SOCKET**

Hammarlund Mfg. Co., Inc.  
424 W. 33 St., New York, N. Y.

MODEL MHS-900. These sockets are designed to clamp the acorn tubes so they do not work loose. Contacts are silverplated beryllium. Socket has a metal shield for use with the pentode-type acorn tube. The base is made of super-Isolantite, called "Iso-Q". Size, 1-9/16 ins. dia., 1-3/16 ins. mounting centers.—Radio-Craft



**A Radio "Ham" Writes to Radio-Craft**

Fenton, Michigan  
105 Pine Street

**S W L**

Date Jan 27, 1940 Station Radio Craft

Your Report Let's have some plans with older type tube

My Receiver 48-606-606-80

QSL Pse David Stiff  
I HAVE

"Dave," a member of the Short Wave League, is interested in radio sets that will enable him to use some of those older tubes he has on hand, we should judge from his card. However, back issues of Radio-Craft contain circuits using older equipment; most readers prefer to learn how to apply the new tubes as rapidly as they appear—or sooner!

**FREE 172 PAGE CATALOG**

**EVERYTHING IN RADIO**  
*At Lowest Prices!*

**YOU NEED THIS BOOK**  
Get your ALLIED Catalog now! You can't afford to be without it if you're a Serviceman, Dealer, P. A. Man, Amateur or Builder. It's the biggest, most complete Radio Catalog out today—your Guide to real money-savings.

60 New Sets. Real Radio hits—new "Antera" and 3-way Portables; new European reception compacts; plastic phono-radlos; home recorder combinations; etc.

New P.A. 18 New Sound Systems—7 to 75 watts—for Electricians, Churches, etc. New Ideas—new applications—new low prices—Time Payment Plan—13 Day Trial Offer, etc.

Servicemen. New Test Equipment—new tools and gadgets—more than 15,000 quality replacements parts. Big Special Bargain Section.

Builders. Count on ALLIED for all the new kits and builders supplies. You can depend on ALLIED as your Radio Supply Headquarters because ALLIED is the 100% Radio House.

**ALLIED RADIO CORP.**  
833 W. Jackson Blvd., Dept. 2-H-0  
Chicago, Illinois  
Send your FREE 1940 Radio Supply Catalog.

Name .....  
Address .....  
City ..... State .....

**ELEMENTARY MATHEMATICS**

**EASY - SIMPLIFIED - PRACTICAL**

HERE is a book for the business man, the technician and craftsman explaining and answering every operation and meaning with interpreting illustrations and examples. It is the key to a simple understanding of many perplexing problems in daily life. In clear, positive and definite language, the author popularizes and clarifies every subject and helps the reader to overcome any apparent difficulty in the study of mathematics. A real home study-course in mathematics for the student or the man who wants to achieve proficiency or desires to brush-up on his knowledge.

Entire Chapter on Special Mathematics for the Radio Technician

**CONTENTS OF BOOK**

CHAPTER I. Arithmetic—Addition—Subtraction—Multiplication—Division.

CHAPTER II. Factoring and Cancellation—Fractions—Decimals Percentage—Ratio and Proportion.

CHAPTER III. The Metric System.

CHAPTER IV. How to Measure Surfaces and Capacity (Geometry).

CHAPTER V. Powers and Involutions—Roots and Evolution.

CHAPTER VI. Mathematics for the Manual and Technical Craftsman—Thermometer Conversions—Graphs or Curve Plotting—Logarithms—Use of the Slide Rule.

CHAPTER VII. Special Mathematics for the Radio Technician.

CHAPTER VIII. Commercial Calculations—Interests—Discounts—Short Cut Arithmetic.

CHAPTER IX. Weights and Measures—Useful Tables.

"Practical Mathematics" can be carried readily in your pocket. Send Stamps, Cash or Money Order.

**ONLY 50c POSTPAID**

**TECHNIFAX**  
1917 S. State St. RC-840 Chicago, Ill.

**YOU ARE WELCOME**  
to one of our fine Illinois Time-Tested Tubular Paper Condensers, free and postpaid, if you'll just send us the name of your jobber. Write NOW!

**ILLINOIS CONDENSER CO., Inc.**  
1160 N. Howe St. Chicago, Ill.

# For Better Servicing - For Bigger Profits— USE GERNSBACK MANUALS AND BOOKS!



SINCE 1931 Servicemen have been buying more GERNSBACK OFFICIAL RADIO SERVICE MANUALS year after year. The authentic material, easily accessible diagrams and complete service data make them invaluable to dealers and radio Servicemen. *Without a Gernsback Service Manual at the repair job, there's time and profit lost.* Your service kit or laboratory is incomplete without all the GERNSBACK OFFICIAL RADIO SERVICE MANUALS. There are GERNSBACK MANUALS for servicing auto-radios, also refrigeration and air conditioning equipment.

## VOLUME 7 OFFICIAL RADIO SERVICE MANUAL

Over 1,800 Pages • Over 3,000 Illustrations • Stiff, Leatherette, Looseleaf Covers • Size 9 x 12 Inches • Net Weight 10 1/4 lbs. **\$10.00**

## 1936 OFFICIAL RADIO SERVICE MANUAL

Over 1,200 Pages • Over 2,500 Illustrations • Stiff, Leatherette, Looseleaf Covers • Size 9 x 12 Inches • Net Weight 8 lbs. **\$7.00**

## 1935 OFFICIAL AUTO-RADIO SERVICE MANUAL

Over 240 Pages • Over 500 Illustrations • Flexible, Leatherette, Looseleaf Covers • Size 9 x 12 Inches • Net Weight 1 3/4 lbs. **\$2.50**

## 1934 OFFICIAL RADIO SERVICE MANUAL

Over 400 Pages • Over 2,000 Illustrations • Flexible, Leatherette, Looseleaf Covers • Size 9 x 12 Inches • Net Weight 2 1/4 lbs. **\$3.50**

## 1932 OFFICIAL RADIO SERVICE MANUAL

Over 1,000 Pages • Over 2,000 Illustrations • Flexible, Leatherette, Looseleaf Covers, Size 9 x 12 Inches • Net Weight 4 1/2 lbs. **\$5.00**

## OFFICIAL REFRIGERATION SERVICE MANUAL

(Volume II)  
Over 352 Pages • Over 300 Illustrations • Flexible, Leatherette, Looseleaf Covers, Size 9 x 12 Inches • Net Weight 1 1/2 lbs. **\$5.00**

## OFFICIAL AIR CONDITIONING SERVICE MANUAL

Over 352 Pages • Over 600 Illustrations • Flexible, Leatherette, Looseleaf Covers, Size 9 x 12 Inches • Net Weight 2 1/4 lbs. **\$5.00**

To order these famous Manuals, see or write to your jobber or favorite mail order house. If more convenient, mail coupon directly to publishers.

**RADCRAFT PUBLICATIONS, Inc.**  
20 VESEY STREET NEW YORK, N. Y.

## RADIO-CRAFT LIBRARY SERIES

Get into the swing of reading instructive, authoritative books on technical subjects—radio, air conditioning and refrigeration. It's the easiest, quickest and most inexpensive way to improve your knowledge on these topics. In this series, popularly known as the RADIO-CRAFT LIBRARY SERIES, are all the titles necessary to your personal advancement. Only by careful study of these enlightening books, can you gain adequate experience in fields of radio, air conditioning and refrigeration. Each book is uniform. The volumes measure 6 x 9 inches—contain 64 pages, and have stiff, flexible covers. PRICE 50c PER BOOK. All books are sent to you postpaid.

### Here Are The Titles:

Book No. 2 MODERN VACUUM TUBES	Book No. 16 PRACTICAL RADIO CIRCUITS
Book No. 3 THE SUPERHETERODYNE BOOK	Book No. 17 SERVICING WITH SET ANALYZERS
Book No. 6 BRINGING ELECTRIC SETS UP-TO-DATE	Book No. 18 POINT-TO-POINT RESISTANCE ANALYSIS
Book No. 9 AUTOMOBILE RADIO AND SERVICING	Book No. 19 PRACTICAL RADIO KINKS AND SHORT CUTS
Book No. 10 HOME RECORDING AND ALL ABOUT IT	Book No. 20 THE CATHODE-RAY OSCILLOSCOPE
Book No. 13 ABC OF AIR CONDITIONING	Book No. 21 BREAKING INTO RADIO SERVICING
Book No. 14 POCKET RADIO GUIDE	Book No. 22 NEW RADIO QUESTIONS AND ANSWERS
Book No. 15 ABC OF REFRIGERATION	Book No. 23 PRACTICAL PUBLIC ADDRESS

EACH BOOK IN THIS SERIES—50c

RADCRAFT PUBLICATIONS, Inc., 20 VESEY ST., NEW YORK, N. Y.  
Gentlemen: Enclosed find my remittance of \$..... for which send me, POSTPAID, the Manuals or Books indicated below by a cross (x) in the panel.

( ) Volume 7 @ \$10.00 ( ) 1936 Manual @ \$7.00 ( ) 1934 Manual @ \$3.50  
( ) 1935 Auto-Manual @ \$2.50 ( ) 1932 Manual @ \$5.00  
( ) Refrigeration Manual (Vol. 2) @ \$5.00 ( ) Air Conditioning Manual @ \$5.00

RADIO-CRAFT LIBRARY SERIES @ 50c EACH

Circle book numbers wanted: 2 3 6 9 10 13 14 15 16 17 18 19 20 21 22 23

Name ..... Address .....

City ..... State .....

(Send remittance in form of check or money order; register your letter if you send cash or unused U. S. Postage Stamps.) RC-840



**SOME RECENT ENGINEERING DEVELOPMENTS**

**M**OST difficult to appraise are contributions of research to any one year's advances. Major advances from the laboratory may be reflected in a product commercially introduced during the same year, but it is much more likely that the research and fundamental engineering will be more apparent in the products of future years. In the research and other laboratories and in the engineering departments, investigations continue unabated—investigations in some cases reflected in a product commercially introduced during the year, but most commonly apparent in technical-society papers and presentations and, for the moment at least, more quickly recognized as pure or unapplied science.

To describe all of these developments in a single field, or even a few in a number of related fields, would consume more space than is here available. However it is possible to brief some of the most interesting engineering developments made during a limited period by a single research group.

Description of the unusual photoelectric tube here illustrated therefore affords an opportunity to mention, for such interest as it may hold for technicians, comparatively recent developments of General Electric Company.



Window "bubble" passes U.-V. rays to sodium cathode.

**Electronics.**—To start, we analyze the outstanding feature of the *bubble-window tube* here illustrated. The window which is only 0.002-in.-thick is made of special ultra-violet-transmitting glass which passes light, at wavelengths up to 2,500 A.U., to a sodium cathode. A tube of this construction replaces a more expensive quartz-bulb tube. The new tube may be used in mercury-vapor detection, and the measurement of low-pressure mercury germicidal lamps.

**Metals.**—By utilizing a steel sheath, to direct the magnetic flux against the keeper, around an alnico pellet using a new grade of alloy called Alnico IV, made by the *powder* process, it is possible to lift a weight approximately 1,500 times heavier than the magnet.

**Printing.**—There was produced a *photoelectric system of color register control* whereby registration of 4 colors can be maintained automatically within the toler-

**SUPER BARGAINS**

Practically all of the attractive items listed here are brand new, others are reconditioned like new; but ALL are in PERFECT WORKING ORDER. In many cases, the parts alone total more than the price we are asking. 100% satisfaction guaranteed or your money refunded. ORDER FROM THIS PAGE. Use the convenient coupon below. Include sufficient extra remittance for parcel post charges, else order shipped express, collect. Any excess will be refunded. C.O.D. shipments require 20% deposit. If extra remittance accompanies order, deduct 2% discount. Send money order, certified check, new U. S. stamps. No C.O.D. to foreign countries.

ORDER TODAY LIMITED QUANTITIES PROMPT SHIPMENTS ASSURED

**G.E. INDUCTION DISC MOTOR FOR RECORDING PLAYBACK AND DISPLAY PURPOSES**



ITEM NO. 81 YOUR PRICE ..... \$3.95

Substantially constructed by General Electric, this ball-bearing motor is a high-quality phonograph unit. Its power and smooth-running make excellent home recording work. Its speed, governor-controlled, is variable both below and above 78 r.p.m. For 110 volts, 60 cycles, A.C. Sold less turntable and shaft. 7 1/4" diameter x 5 1/4" high. Shp. Wt. 1 1/2 lbs. Packed in Original Box.

**SUPER SPECIAL**

**3 1/2 R.P.M. SYNCHRONOUS MOTOR**

There are 101 uses for a synchronous motor making only 3 1/2 revolutions per minute. Ideal for crowd-catching store-window displays, actuating film-developing tanks, as an electric winch on model motor boats, as derick motor in erector sets, etc. Built-in high-ratio step-down gears provide amazing amount of power. Made by Haydon Mfg. Co. of Watertury. 2" in diameter x 2 1/2" x 1" thick overall. Shp. Wt. 2 lbs.

110 Volt, 60 Cycle A.C. Only



ITEM NO. 76 YOUR PRICE ..... \$1.95

**A.C. "SQUIRREL CAGE" SYNCHRON. MOTOR**

Self-starting shaded pole motor designed for radio chassis for Push Button Tuning. High speed, powerful. One lubrication lasts lifetime. Excellent for model railroad trains, small boats, humidifier water pumps, etc. 1/2" long shaft, 3/16" diameter. Complete with brass mounting posts. 2 1/4" x 2" x 2 1/4" overall. For 110 volts, 60 cycles, A.C. only. Shp. Wt. 4 lbs.

ITEM NO. 77 YOUR PRICE ..... \$1.35

**MECHANICAL FLASHLIGHT**

This battery-less flashlight generates its own power merely by pressing handle. Gives strong light whenever needed. Costs nothing to maintain. Amazing new miniature dynamo operates flashlight. Pocket size. 4 1/2" x 2" x 1". Shp. Wt. 2 lbs.



ITEM NO. 88 YOUR PRICE ..... \$1.70

**MOTOR FOR ROTATING RADIO BEAM ANTENNA**

Built by Honeywell as a temperature regulator for coal fired furnaces but ideal for many other uses, especially for rotating beam antennas on the roof for directional beaming and reception of radio signals. Built-in commutator switching permits turning antenna from north-south to east-west direction from remote point. Constructed for hard usage. Has double-end shafts geared down to about one revolution per minute. Ideal for window displays and other slow-moving mechanical motions. 1 1/2" coils, 60 cycles, A.C. only. 6 1/2" x 6 1/2" x 4 1/2". Shp. Wt. 10 lbs.

ITEM NO. 82 YOUR PRICE ..... \$5.95

**AMAZING BLACK LIGHT!!**

Powerful 300-Watt Ultra-Violet Bulb



The best and most practical source of ultra-violet light for general experimental and entertainment use. Makes all fluorescent substances brilliantly luminescent. No transformers of any kind needed. Fits any standard lamp socket. Made with special filter glass permitting only ultra-violet rays to come through. Brings out beautiful opalescent hues in various types of materials. Swell for amateur parties, plays, etc. to obtain unique lighting effects. Bulb only. Size of bulb. Shp. Wt. 1 lb.

ITEM NO. 87 YOUR PRICE ..... \$2.00

**SUPER MAGNET**

LIFTS MORE THAN 20 TIMES ITS OWN WEIGHT

**LITTLE GIANT MAGNET.** Lifts 5 lbs. easily. Weighs 4 oz. Made of ALNICO new high-magnetic steel. Complete with keeper. World's most powerful magnet ever made. The experimenter and hobbyist will find hundreds of excellent uses for this high quality permanent magnet. Measures 1 1/2" x 1 1/2". Shp. Wt. 3/4 lbs.



ITEM NO. 85 YOUR PRICE ..... \$1.00

**BRAND NEW! BATTERYLESS BIKE-LITE**

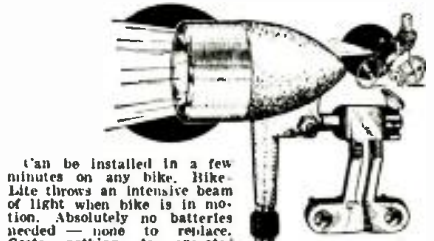

Can be installed in a few minutes on any bike. Bike-Lite throws an intensive beam of light when bike is in motion. Absolutely no batteries needed—none to replace. Costs nothing to operate. Small, built-in generator, turned by the bike wheel supplies unflinching current. Most economical headlight yet. Guaranteed for lasting performance. All metal construction with beautiful silver finish and polished chromium-plated reflector. Armature operates with a powerful Alnico General Electric permanent magnet. Measures 4" x 5 1/2". Complete with bulb and instructions, ready to attach. Shp. wt., 3 lbs.

ITEM No. 90 YOUR PRICE ..... \$2.10

**SEWING MACHINE MOTOR**

For electrifying foot-treadle sewing machines and replacing burned-out motors on electrified machines. Powerful and high-speed; numerous other uses. Ideal as handy grinder-polisher motor. Small, compact, flat on two sides, requiring a minimum of space. Speed controllable by foot-pedal rheostat (available optionally for \$3.75). Is 1/2" diam. shaft is available with or without pulley (pulley 15c extra). Completely enclosed and dirt proof. Measures 3 1/2" x 5" x 2" overall. Shp. Wt. 7 lbs.

ITEM NO. 79 YOUR PRICE (motor only) ..... \$3.75

**HUDSON SPECIALTIES CO., 40 West Broadway, N. Y. C.**

WE HAVE NO CATALOG. IT'S EASY TO ORDER—CLIP COUPON—MAIL NOW ORDER FROM THIS PAGE

HUDSON SPECIALTIES CO., 40 West Broadway, Dept. RC-840, New York, N. Y.

I have circled below the numbers of the items I'm ordering. My full remittance of \$..... (Include shipping charges) is enclosed.

OR my deposit of \$..... is enclosed (20% required), ship order C.O.D. for balance. (New U. S. stamps, check or money order accepted.)

Circle Item No. wanted: 76, 77, 79, 81, 82, 86, 87, 88, 90

Name ..... Address .....

City ..... State .....

Send remittance by check, stamps or money order; register letter if you send cash or stamps.



## Signal Chaser

A LOW-COST practical tester that cuts servicing time and cost. You can: make stake analysis tests (signal chasing) of all RF, IF and AF stages; voltage, resistor and condenser tests; locate man-made interference; check for polarity: hum, AC and DC continuity, and many, many other tests. May be used on all sets, including television and frequency modulation.

### LOCATES MAJORITY OF ALL ORDINARY SERVICING TROUBLES ONLY

Employs triple-purpose 1DHGT tube in a simple, fool-proof circuit. Self-contained batteries make it usable anywhere. Both headphone (audio) and neon-tube (visual) indication of tests. Compact, light weight, portable: 10 x 5 x 3 ins.

**\$14.95**

with tubes, batteries, less phones.

**ALLAN STUART**

P. O. Box 36

Teanack, N. J.

ance permissible in Intaglio or rotogravure printing when operating at web speeds of approximately 1,000 feet-per-minute. Paper loss is greatly reduced and the quality of the product is considerably improved by this use of the "electric eye."

The control system incorporates 2 photoelectric scanning heads for each color unit. One head is aligned to scan the margin of the web, on which equally-spaced register or index marks are printed simultaneously with the 1st color impression. The 2nd head is arranged to scan a disk attached to the printing cylinder. Should the printing cylinder be slightly ahead of or back of true register position, the impulses from one head will be correspondingly ahead or back of the impulse from the other head, causing an unbalanced condition in a "mixing panel." A correction is then automatically applied by a reversible pilot motor in response to the corrective impulses from the "mixing panel" relayed through close-coupled thyratron power tubes.

**Therapeutic X-Ray.**—A new *gas-insulated* 1,000,000-volt X-ray therapy apparatus utilizes a transformer designed to operate at resonance, thus eliminating the iron core and permitting the multisection X-ray tube to be placed in the center of the transformer

coil system.

This feature of design, together with the use of *freon gas* as an insulating medium, results in a big saving in size and weight.

**Diagnostic X-Ray.**—An important addition to the family of G-E Coolidge X-ray tubes is a diagnostic unit. Shockproof and *oil-immersed*, this tube unit is much more compact and lighter in weight than its predecessors. It is the first diagnostic tube to incorporate an *oil-cooled cathode* for rapid removal of heat from this structure, thereby eliminating cathode-gas problems to improve tube performance and increase working capacity.

**Fluoroscopic X-Ray.**—The new X-ray Tire-o-scope shows the car owner where and why a "puncture" or "blow-out" may occur. Without removing the tires from the automobile, a service station or garage operator now may, by X-ray, look into the tire to detect breaks, bruises, cord separations that are otherwise hidden, and such foreign material as tacks, nails, wire, screws, glass, and stones imbedded in the casing. The driver is assured that his tires are safe, or is given warning with definite proof that tires are unsafe and should be replaced or repaired to provide safe riding.

**Varnished Cambric Insulation.**—Heavier loads may be used, higher voltages withstood, and more severe operating conditions met with a new varnished cambric for cable insulation. Similar in appearance to the black (or "Empire"—Ed.) cloth previously used, the new high-temperature varnished cloth permits cable to be operated at a maximum copper temperature approximately 10° C. higher than the old cloth. It also has lower dielectric losses, and is as good or better in all other respects than the old type of cloth.

**Carrier Current—Communication.**—In the standard line of single-frequency simplex and 2-frequency duplex communication equipment the incorporation of *automatic modulation control* has not only increased the range of communication by raising the strength of weak modulating signals but also prevented cross-modulation on closely-adjacent channels.

Need for expensive dial-calling methods was reduced by the introduction of a *60-cycle code-bell calling system*, similar in performance to standard metallic magneto calling and employed in place of loudspeaker voice-calling.

**Carrier Current — Relaying.**—Transmitters and receivers were developed to facilitate use of the same channel for simplex point-to-point communication, control, or telemetering in addition to relaying, with increased receiver selectivity and higher transmitter output when operating from station control batteries.

**Carrier Current—Control.**—New circuits and mechanical arrangements were developed to provide fixed audio-tone modulation of essentially standard telephone transmitters and receivers up to a maximum of 4 simultaneous impulses, for telemetering, control, and indication, thus greatly expanding the services available over a single power-line carrier channel.

A medium-frequency transmitter and receiver was developed to provide telemetering and similar services over suitable telephone circuits where the absence of power lines or unusual conditions prevent the use of a power-line channel.

**Accessories.**—Investigations into the dielectric properties and propagation characteristics of concentric (coaxial) cable led to the adoption of a *tellurium compound-covered cable* suitable for overhead or underground construction, and possessing a new concentric dielectric of great permanence, stability, and low losses.

## WARNING TO RADIO-CRAFT READERS

Radio-Craft has no representatives in the field soliciting subscriptions, in the "door to door" fashion. Pay no money to any person who comes to your home, store or service shop and represents himself as being an agent for Radio-Craft. Subscriptions may be safely obtained only from authorized subscription agencies, whose names we shall be glad to furnish, or directly from us by mail. Address your letter to Subscription Dept., Radio-Craft, 20 Vesey St., New York, N. Y.

## Get This Electric Dry Shaver ABSOLUTELY FREE!

JUST THINK OF IT—you can get absolutely FREE, the useful DRY ELECTRIC SHAVER which is shown at the left. This ELECTRIC DRY SHAVER is sent to you by the publishers with a one-year subscription to RADIO-CRAFT.

### Here Are the Features of The ELECTRIC DRY SHAVER

Constructed of metal with attractive red bronze finish. Scientifically constructed to give a perfectly clean shave. 5-foot rubber insulated cord and plug. Constructed to last for many years.

Operates from 110-volt, 60-cycle A.C. electric line. Carries a two-year manufacturer's guarantee. A fine quality, self-sharpening toilet necessity.

Send your subscription to RADIO-CRAFT for One Year (12 issues) and receive absolutely FREE one of these remarkable Electric Dry Shavers. New subscribers are accepted or you may extend your present subscription another twelve months. Mail your remittance of \$2.00 (plus 25¢ for shipping charges on Shaver) to the publishers, (Canada and foreign \$2.75.) You will receive your DRY ELECTRIC SHAVER immediately by return mail. Use coupon below to enter your subscription.

### RADIO-CRAFT

20 Vesey Street, New York, N. Y.

RADIO-CRAFT, 20 Vesey Street, New York, N. Y.

Gentlemen: Enclosed find my remittance of \$2.00 for which enter my subscription to RADIO-CRAFT for one year (12 issues). Send me immediately FREE, ELECTRIC DRY SHAVER (Canada and foreign \$2.75). In U. S. add only 25¢ additional to cover shipping charges on Shaver.

New Subscriber  Extend Present Subscription

Name .....

Address .....

City ..... State .....

(Send remittance by check, money order or unused U.S. Postage Stamps. Register letter if you send cash or stamps.) RC-8-40

OPERATES ON 110-VOLT, 60-CYCLE A.C. LINE

WE SHIP ELECTRIC DRY SHAVER THE SAME DAY YOUR SUBSCRIPTION ORDER IS RECEIVED.

CLIP COUPON— AND MAIL!



All the worthwhile  
Radio Trade News  
of the past Month—  
Digested for busy  
radio men.

# RADIO Trade Digest

A PLEDGE: — To  
print the important  
news of the radio  
industry; to review  
major news events;  
to help point a path  
to radio profits.

IMPORTANT HAPPENINGS OF THE MONTH IN THE RADIO INDUSTRY

No. 24

AUGUST, 1940

No. 24

## F.C.C. AUTHORIZES COMMERCIAL F.M.

*Forty U.H.F. Channels Assigned for  
the New Broadcasting Art. Five  
Channels Are Non-Commercial*

Acting with unusual speed the Federal Communications Commission has given frequency modulation the green light to go ahead with commercial operation. Forty U.H.F. channels have been assigned this type of broadcasting and only 5 of them are retained for non-commercial work. The Commission does not feel that present-day radio sets will be made obsolete at least for a period of years.

The major portion of the radio industry was highly elated at the news and some spokesmen foresaw a "life-saving boom."

A prominent consultant to the trade foresees a great opportunity for sales in South America. Most manufacturers, he points out, will be concentrating on the domestic market. However, he stresses that South America with its heavy static is an ideal spot for the sale of F.M. transmitters and receivers, as these are less affected by electrical and magnetic disturbances.

With the European and patent situations as they are, he suggests that now is the time for American mfrs. to introduce F.M. to the Western Hemisphere and absorb the market.

## WAR SITUATION FORCES F.C.C. TO RESTRICT "HAM" BROADCASTS

*Sales of Amateur Radio Equipment Expected to Take Sharp Drop.  
Contacts Limited to U.S.A. and Possessions Only*

### PHILCO GOES PUBLIC

Philco stockholders have cleared the way for public participation in the ownership of the corporation's securities. (Heretofore Philco has been a privately-owned company.) As a result, par value of the outstanding common stock has been changed from \$100 to \$3. Each share of present common stock has been exchanged for 33 1/3 shares of new common stock. Outstanding shares of common stock now become 1,221,100 in number, plus 28,385 shares of \$100 par value \$5 preference stock, but no bonds, mortgages or funded indebtedness of any kind.

Present stockholders agreed to sell, through a public offering, part of their holdings of the reclassified common stock. Plans have also been made for a public offering of sufficient additional common stock to obtain funds to retire all outstanding preference stock. Upon completion of these plans, the common stock will represent the only outstanding security of Philco Corporation, and applications will be made to list this stock on the New York Stock Exchange.

Stringent new regulations governing ham activities have just been announced by the F.C.C. These are commercially important in that they may cut into sales of radio equipment & components. At press time the regulations were two-fold: (a) Contacts with hams outside of U.S.A. and possessions were banned; (b) the use of portable rigs was restricted to frequencies above 56 mc. except for special emergency service.

It hardly need be stressed that the greater the transmission distance and the more equipment the amateur is permitted to use, the greater will be his purchases. The fact that his contacts will be limited, for the most part, to this hemisphere means that he will be less inclined to buy the apparatus needed to construct high-power transmitters and super-sensitive receivers. Simpler, less costly, apparatus will probably serve his purpose during the emergency. Similarly he will be less likely to construct a portable post since his use of it will be limited to equipment able to reach only to the horizon. A ray of hope exists in the fact that the war may soon be over. Until then all loyal Americans will cooperate uncomplainingly.

### NEW G.E. INSTITUTE ENTRANCE



Visitors to General Electric in Bridgeport must enter this door & pass through a reception lounge & display of appliances in order to reach factory & offices beyond. Building also houses testing lab & meeting room.

### THE MUSIC GOES 'ROUND & AROUND



New "Roto Base" on RCA Little Nipper model 46X23 permits it to be turned in any direction, thus permitting the built-in loop antenna to be aimed directly at the wanted station thereby increasing signal strength.

## DEMONSTRATES F.M.'S STATIC ELIMINATION



Demonstrator for G.E. F.M. sets, permits dealer to show how this transmission - reception operates free from man-made static, by playing record on wireless record player through F.M. and A.M. sets. Electric razor, well-known "static generator" is also feature of demonstration.

**\$'s & No.'s**

\$328,202 NET PROFIT for the first 3 months of 1940 is the record of Stewart-Warner Corp. Equivalent to extra earnings of 26c per share, after provision for Federal income tax and Canadian exchange. Equivalent period of 1939 produced only \$146,275. Gross profits were \$1,364,595.

DIVIDEND OF 87½c per share on first preferred stock and \$1.25 per share on "B" preferred stock was declared by RCA. These dividends are for the period from April 1, 1940 to June 30, 1940 and were paid on July 1, 1940 to stockholders of record at the close of business June 7, 1940.

189 IS THE TOTAL number of affiliated stations of the National Broadcasting Company with the addition of KRBM, Bozeman, Mont.; and WSJS, Winston Salem, N. C. The former operates full time on 1,420 kc. with 250 watts; the latter, full time on 1,310 kc. with 250 watts.

\$1,073,925 WORTH of radio receiving sets were exported in March, 1940, as compared with \$730,417 worth in February, 1940, and \$875,746 worth in March, 1939. The United Kingdom was biggest customer, with 60,682 sets valued at \$440,182. Other major markets included Brazil, \$77,059 worth; Mexico, \$60,810; Union of South Africa, \$56,375; and Venezuela, British India, Chile and the Philippine Islands, all of which took shipments ranging from \$50,000 down to \$38,000.

\$2,567,042 WORTH OF PENSIONS was paid out by General Electric during 1939. On December 31, 1939, 3,410 pensioners were on the rolls with an average age of 69.3 years, an average continuous service of 29.3 years, and an average annual pension of \$756.00.

\$2,945,244 is the consolidated earned surplus of Zenith Radio Corp. for the yr. ended April 30, 1940. Its net profit for the yr. ended April 30, 1940 after depreciation, taxes and prior yr. adjustments was \$738,083. The co.'s cash & cash resources, according to its annual report just released, is \$1,775,265 including \$500,000 in U. S. government treasury bills.

**FCC THREATENS NETWORKS**

The FCC (which does not stand for Fifth Column Cohorts), having slipped the dagger between the shoulderblades of television, is now whetting its knife for the networks.

A Commission triumvirate held that contracts signed between major nets and their outlets were unfair to the latter, in that they tie the outlet exclusively to one net, refuse to let it sell time for less than the network rate, and are for excessively long periods.

The 3-man committee, however, failed to charge that men with guns and whips compelled the outlets to sign the contracts.

**Personal**

LOUIS A. McNABB is dir. of the new electronics div. of Bell & Howell. This leading movie camera co. is planning entry into the sound equipment & television fields.

GEORGE W. RUSSELL, *Sentinel Radio* sales mgr., reports situation in South indicates this will be banner yr.

PHILIP D. REED was reelected chairman of the G.E. board & CHARLES E. WILSON pres. All other officers were also reelected.

WALTER R. JONES, *Hygrade Sylvania* commercial eng., is back from a radio service lecture tour in the Central South & reports especially lively interest in oscillator circuits and battery receivers as far as Servicemen are concerned.

P. A. TILLEY (no relation to Eustace) has been appointed ass't mgr. of G.E.'s radio & television dept. with hq. in Bridgeport, Conn.

CHARLIE GOLENPAUL has celebrated his 10th yr. with *Aerovox*. Prior to that he was with Clarostat.

Changes in the FCC include TELFORD TAYLOR succeeding W. J. Dempsey as gen. counsel, & JOS. L. RAUH, Jr., succeeding W. C. Koplovitz as ass't gen. counsel.

LAURENS HAMMOND, the big electronic organ man, received a 1940 medal

**TIMELY TELLY TRENDS**

• The N.Y. Police Dept. was given a Farnsworth television receiver when members of its police athletic league won a boxing contest locally promoted for youngsters.

• Du Mont has abandoned production on all receivers smaller than those using 14- or 20-in. C.R. tubes.

• Thomas F. Joyce, v.p. of RCA Mfg. Co. predicts that within a yr. after the F.C.C. OK's commercial telly 25,000 receivers will be sold in the N.Y. area alone. He also thinks that Americans will buy 1,000,000 telly sets within 5 yrs. (Recent check-up of sales figures in N. Y. shows weekly sales not 100 sets per wk. but 160.)

• Miss RCA Television at N.Y. World's Fair was partly selected by votes of television audience who saw dozen damsels demonstrate pulchritude & talent over the air. Typical home comment was "Ah, the high school elocution class!"

• The newly organized Television Institute of America in Hollywood, Calif., does not have a technically impressive board. Arthur A. Stern, Hollywood business man, is secretary-treasurer; Edna Williams, "prominent in the motion picture industry"; and G. H. Seward, of Hollywood Television Artists & Writers Guild, is founder-president.

• Du Mont Labs. have just issued a special bulletin covering new C.-R. tube type designations. A letter contained in the type number designates the screen: A—medium-persistence green; B—long-persistence green; C—short-persistence blue; D—medium-persistence white.

• Despite trade paper survey showing 100 television receivers sold weekly in N.Y. area correct figures are more than 50% greater.

• Shift in television channels due to FCC's commercialization of F.M. has television mfrs. worried about possible changes necessitated in television receivers in area serviced by W2XBS whose channel would be wiped out.

award from the Franklin Institute of the State of Pa. "in consideration of the inventive skill displayed in the development of the Hammond organ."

STEPHEN NESTER, sales mgr. of *Recoton Corp.* won the Advertising Club's silver medal in the Selling & Advertising essay competition.

ALLAN R. ROYALE succeeds Clifford J. Hunt as sales rep. in the Phila., Balto. and D.C. districts. Hunt has become mgr. of the co.'s distributor div.

JACK CLUNE, *Nat'l Union's* office mgr., has graduated with a B.S. degree from Fordham U. He took the course in his spare time.

GUY FLAIG has been made mgr. of the *Crosley Distrib. Corp.* of Cincinnati. Mr. Flaig has been a distrib. & mfrs.' rep. in Cincinnati for 15 yrs.

L. MARTIN KRAUTER for 4 yrs. copy chief of the Cramer-Krasselt Adv. Agcy. has been made adv. & sales promotion mgr. of the *Crosley Corp.* In the same co. WILLIAM M. SHIPLEY has been made mgr. of account sales.

ANTHONY G. SCHIFINO who formerly operated the Rochester Radio Supply Co. has taken charge of sound system engineering at *Stromberg-Carlson*.



## AN EDITORIAL

By Artie Dee

The Consolidated Edison Co., as you know from seeing the figures on the sales derived on some of their deals, are no dopes. *Radio-Craft* received additional proof thereof a couple weeks after moving to its new address. It also received an idea which should help you make money.

A letter signed by the v.p. of Consolidated Edison says: "Now that you have had time to 'size up' your new place, perhaps you have found things that need attention . . ." and goes on to say that maybe we could use better lighting, a new ventilating system, etc. An enclosed postcard invites us to have a representative call to give us free advice on our lighting, air conditioning, etc.

You know when moving day is in your town. You know the leading rental agencies and moving companies. Have you been to see them?

They can give you information as to persons who have moved into new quarters. These persons are natural customers for antenna installations, if nothing more. They are potential customers for alteration of receivers from A.C. to D.C., or D.C. to A.C. They are also possibilities for sales of new and better radio equipment. (Old furniture always looks at its worst in a new home.) Talk-up office interphones!

A postcard—a letter—a personal visit from you or your salesman may mean more than an initial sale. It may mean establishing a contact for long and profitable service connections. A logical method is to send out a letter specifically aimed at the new resident. You may be able to sell an annual service contract in conjunction with a special-rate installation fee. You will certainly be able to let him know of a good reliable Serviceman in his neighborhood, ready to dash to the rescue when his set goes sour.

Stop saying that business has gone to Sheol. Even if it has—go after business.

## Sales Helps and Deals

**WILLARD STORAGE BATTERY CO.** has run off a series of 27 electrical transcriptions featuring air and screen stars for local radio station use. A commercial provides for local dealer tie-in.

Punchboards are being used to push the sale of **KENT A.C.-D.C.** portables.

**PHILCO'S** 4-in. square aerial demonstrator generates terrific static causing terrible reception until "super loop" in receiver is adjusted. Co.'s parts sales mgr. says demonstration is more convincing than star salesman's best spiel.

Cut prices up to 90% on surplus stock of guaranteed genuine parts & new P.D. ice-cube tray are 2 **PHILCO** deal offers.

**WQXR**, hi-fi station in N.Y., sells complete printed programs for \$1 per yr. and has a nice sideline from including ads in the booklet and stuffers in the envelope.

## NEW DEAL ON TEST INSTRUMENTS

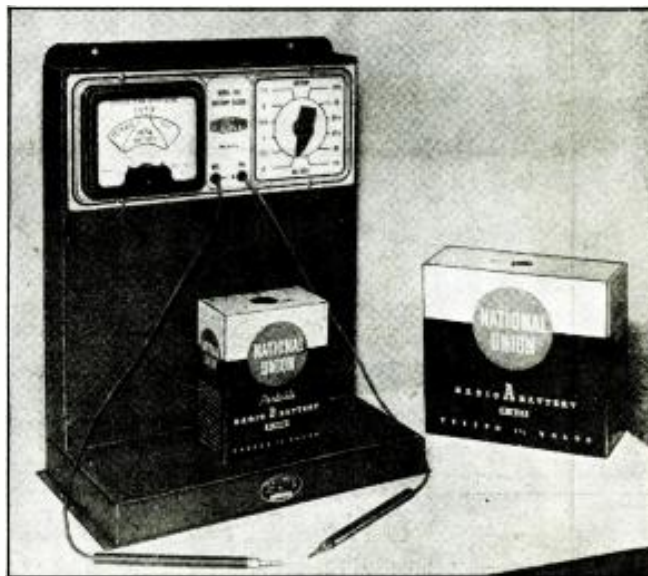

National Union, now putting out branded "A" and "B" batts, offers a deal on counter-model Triumph Mfg. Co. battery tester. Dealer can use it to demonstrate condition of old & new batteries.



Servicemen are invited to enter Allen B. Du Mont Labs.' "Cathode-Ray Tube Application Contest" which runs for a yr. beginning June 1, 1940. Get the dope straight from Du Mont. . . . 5 new models in the G.E. line include an auto-radio & 4 portables. . . . Stewart-Warner has introduced a special de luxe line. . . . Harold Davis, Inc., Miss. parts house, will run its post-graduate radio course in Jackson, Miss., July 15-27.

G.E. has built & equipped an Institute of Electrical Living in Bridgeport, Conn. . . . Stromberg-Carlson is marketing a complete kit for repairing damaged or worn "flock" (whatever that is) on radio-phonographs. . . . Nat'l Union has become exclusive U.S. sales agent for sound systems made by Erwood Sound Equipment Co. . . . DeJur-Amsco Corp. is now putting out a complete line of ammeters, milliammeters, microammeters & voltmeters in 2, 3, & 4 in. sizes, round and square cases. Aims particularly at mfrs.

Farnsworth Tel. & Radio Corp. held its 2nd annual internat'l sales conference at the Edgewater Beach Hotel in Chi.; about 300 reps. from U.S. & S.A. saw the new line. . . . G.E.'s new wireless record player is non-directional; there is also a new wired job. . . . Same co. now tests apparatus by giving it thorough shaking. . . . Stromberg-Carlson believes that F.M. "will revitalize the entire industry."

*Flash! Place no faith in rumors that NBC will abandon television if forced to make costly changes in W2XBS transmitter. Fact is that so many RCA television receivers have been sold on time, with payment deferred over 18-mo. period, that co. must continue to supply programs in order to insure payoff.*

## CORRECTION

Your Trade Digest editor has been informed that the Trymo Copycraft & Supply Company is a company separate and distinct from Trymo Radio Co., Inc., and does not supersede it, as our write-up on page 764 of the June 1940 issue inferred. Both companies are in the field doing business—Sorry.

## Changes & New Addresses

### Where to Reach Old and New Companies

**UNITED CINEPHONE CORP.** has moved its offices & plant to Torrington, Conn., taking over more space.

**RADEX CORP.** is in new & larger quarters at 1733 N. Milwaukee Ave., Chicago, Ill.

**ALFRED CROSSLEY**, 549 W. Randolph St., Chicago, Ill., will give sales engineering service on Allen B. Du Mont cathode-ray equipment in that territory.

**NATIONAL RECORDING SUPPLY CO.** is a new firm at 1065 N. Vine St., Hollywood, Calif., acting as exclusive local sales reps. for Universal Microphone Co.'s products. Glenn Wallich & F. H. Brown, well-known in that area, are associated in the enterprise.

**CALLITE TUNGSTEN CORP.** is the new name of the old Eisler Electric Corp. The co. is situated in Union City, N. J.

**THE MAY CO.** in Cleveland & the **RUDOLPH WURLITZER CO.** in Buffalo have been made exclusive outlets for Ansley Dynaphones in their respective cities.

**THE BENJAMIN T. CRUMP CO.** of Richmond, Va., and the **CHARLES S. MARTIN DISTRIB. CO.** of Atlanta (with a branch at Athens, Ga.) have been appointed Farnsworth distributors.

**PARMETAL PRODUCTS CORP.** has moved to 32-62 49 St., Long Island City, N. Y., affording greatly expanded facilities.

**C. G. PYLE**, gen. sales mgr. of lamp operations for Hygrade Sylvania has moved his hq. from Chi. to N.Y.C.

## THIS SET WAS NOT G.W.T.W.

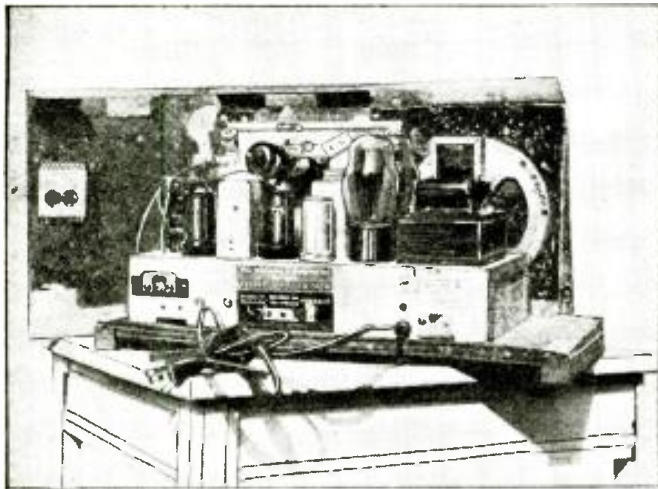

When a tornado struck Albany, Ga., Will Anderson's house collapsed and the set, pictured at left, flew away together with most of his furniture. The set was recovered and returned to the Morrow-Cook Furniture Store for repairs. Accidentally plugged in before work started, it operated perfectly and thus won fame.

## OFF THE PRESS

**FOLDER.** Cornell-Dubilier Elec. Corp., South Plainfield, N. J. Complete listing of condensers for power factor correction of the new fluorescent lamps. Includes circuit and data on calculations of line current for the standard lamp.

**PAMPHLET.** Sprague Specialties Co., North Adams, Mass. 8 pages. Specifications and technical descriptions of coaxial tuning units.

**CATALOG.** Presto Recording Corp., New York, N. Y. 52 pages. Complete line of recording equipment, amplifiers, pre-amplifiers, radio tuners, needles, and other accessories.

**CATALOG.** Atlas Sound Corp., Brooklyn, N. Y. 8 pages. Describes complete line of sound projectors, exponential horns, trumpet units, speakers, baffles, microphone stands and connectors.

**FOLDER.** Ideal Commutator Dresser Co., Sycamore, Ill. 4 pages. Describes all types of hand- and machine-operated wire strippers, DX cable cutters and other electrical accessories.

**FOLDER.** RCA Mfg. Co., Aviation Radio Section, Camden, N. J. Gives complete physical and technical description of model AVR-20 Aircraft Communication Receiver.

**BOOKLET.** Hygrade - Sylvania Corp., Salem, Mass. 18 pages. Describes in detail the advantages of the new fluorescent lamps and lists a variety of models and reflectors.

**CATALOG.** Kenyon Transformer Co., Inc., New York, N. Y. 24 pages. Lists complete line of transformers, replacements,

filter units, new plug-in type transformers. Contains a variety of "Ken-o-graf"'s.

**CATALOG.** General Rotary Antenna Co., Coral Gables, Fla. 8 pages. Lists rotary beam antenna equipment and accessories.

**FOLDER.** J.F.D. Mfg. Co., Brooklyn, N. Y. Lists a variety of frequency modulation and television antennas, including brackets and accessories.

**FOLDER.** Triplett Elec. Instrument Co., Bluffton, Ohio. Describes complete line of portable and panel-mounting meters.

**CATALOG.** Radio Wire Television, Inc., New York, N. Y. 120 pages. Everything in radio, public address, amateur radio equipment, portable, parts, etc.

**CATALOG.** Crowe Name Plate & Mfg. Co., Chicago, Ill. Complete listing of remote control units and matching plates for all auto radios.

**CATALOG.** Terminal Radio Corp., New York, N. Y. 12 pages. Lists complete line of public address equipment, microphones, speakers, phono pickups, phono motors, radio tuners, recorders, etc.

**CATALOG.** National Carbon Co., Inc., New York, N. Y. 8 pages. Lists complete line of drycells and batteries for portables and other applications. Features the new "Mini-Max" "B" batteries for longer life.

**RADIO BUILDERS' HANDBOOK.** Allied Radio Corp., Chicago, Ill. 36 pages. Contains complete constructional data, plans and parts lists for building a variety of receivers, transmitters, amplifiers, photo-cell equipment, etc. Send 10c to Allied Radio for it.

**CATALOG.** Burton Rogers Co., Boston, Mass. 8 pages. Describes a complete line of portable and panel-mounting meters, sold under the trade-name "Hoyt."

**VOLUME CONTROL GUIDE.** International Resistance Co., Philadelphia, Pa. 48 pages. Gives a complete listing of volume control replacements for all commercial receivers, besides listing the various types of controls available, including the various tapers, etc.

**SHEET.** Ideal Commutator Dresser Co., Sycamore, Ill. Describes new instant-heating soldering tool operating from transformer on 110-V. line. A similar tool is described for heating metal conduits where joints are soldered.

## Salesman Sam Says:—

Data issued by U. S. Gov't. Far more detailed information is available from the Bureau of Foreign & Domestic Commerce, Washington, D. C. Publications to request are: World Radio Markets covering countries wanted & The Electrical & Radio World Trade News.

**URUGUAY.**—About 150,000 sets in use by 2,000,000 population, 1/3 of which reside in the capital, Montevideo. The annual market has been about 20,000 receivers, but growing restrictions of import caused by exchange control, seem to be gradually cutting down this figure. Both socket power and battery receivers are in demand. Most of the receivers sold are of the 5- to 6-tube table model type, with all-band reception, and selling at moderate prices. The electric supply is 220 volts, 50 cycles, A.C. There are no demands for phonograph combinations or television receivers. Portable sets are not selling well because of the difficulty of securing suitable dry batteries.

**SWITZERLAND.** 500,250 sets in use by population of 4,000,000. The annual market is estimated at 40,000 domestic and 9,300 imported receivers. The War has boomed the radio market, which will probably remain good if Switzerland is able to remain neutral. Over 99% of the sets sold are of the A.C. variety, A.C.-D.C. sets without a special transformer are prohibited. Five-tube receivers are most popular—these should be preferably of the all-wave variety.

**U.S.S.R.** 450,000 sets in use by population of 165,000,000. The purchase of many items, including radio sets, is very restricted. The Soviet government has emphasized the development of central receiver systems. Outlets are estimated to number 5,500,000 as compared with 450,000 individual receiving sets.

## "PREFERRED TYPES"



The above title applies to both the RCA Victor tubes and the personable person presented with them. The display in 10 colors is 42 ins. high & 25 ins. wide, designed for promotion via window or wall.

## NEW TUBE BOOSTS HAM BIZ

"Ikey", the baby iconoscope just made available by RCA, should prove to be the heart of a flock of sales to the hams who always like to be the chaps who put the "van" in advance. Designed for amateur experimental use, the new television pick-up tube can be used for ham transmission of indoor or outdoor pick-ups. It has the advantage of operating on voltages available from most xmtr power supplies, and requiring but a cheap lens. Other components will be required with it to build sweep circuits and video amplifier to hook into the UHF rig.



HOME-MADE PANEL BRACKET

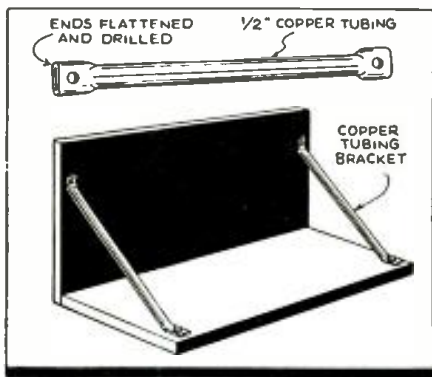

● FOR supporting panels I found that brackets made from 1/2-in. copper tubing were light, strong and inexpensive. The tubing is flattened with a hammer for an inch or so at each end, and then drilled and bent as shown.

DAVID BIRNBAUM,  
Brookline, Mass.

2-CHANNEL MIXER

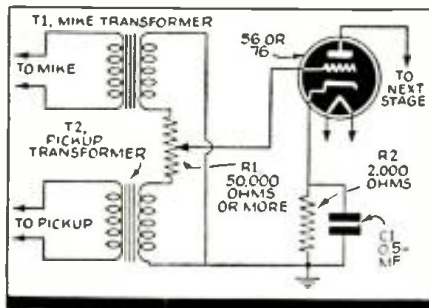

● I WANTED a mixing system for 2 channels but did not want to go to the expense of buying attenuators. I have designed a mixer (see diagram) that will mix 2 channels without requiring the usual expensive attenuators. The system works quite well and yet is inexpensive. The value of the potentiometer will depend a great deal on the transformers used. With a little experimenting the correct value to suit individual cases can be found. It should be at least 0.1-meg.; in most cases it will have to be more.

WINNIE NEAL,  
Huntsville, Ala.

STEADIES LINE VOLTAGE FOR TEST INSTRUMENTS, ETC.

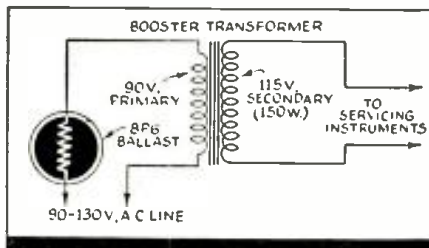

● I HAD trouble with my test instruments on account of the line voltage fluctuating from 90 to 120 volts. A Thordarson Booster Transformer type T-6107, and a ballast resistor from an old Majestic 8P6 power pack, did the trick. This idea may be of value to others who may be experiencing the same trouble.

AUBREY V. SCHROEDER,  
Loyalton, Calif.

STAGE ANALYZING WITHOUT A STAGE ANALYSIS TESTER!

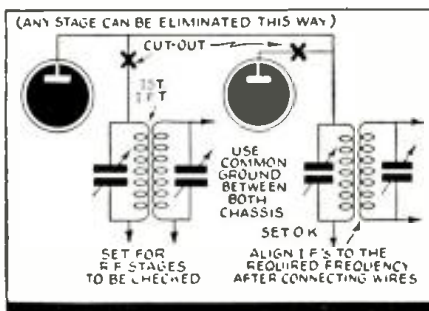

● IT IS sometimes very difficult to check a set if one has not a channel tester or some similar instrument. I have been using the following trick for a long time.

To check I.F. stages I remove the 1st-detector tube and solder a wire (as short as possible) to the plate of the 1st-detector tube socket; the other end is soldered to the plate of a radio set which is quite OK. Now remove the 1st I.F. primary lead from the socket, connect a common ground to both the chassis, and turn them "on." By using this kink one can easily find out many faults which cannot be traced out so very easily such as defective I.F. transformers, crackles, intermittent reception, fading, etc.

R. J. ANTIA,  
Mirzapur,  
Ahmedabad, India.

OUTPUT TRANSFORMER AS FILAMENT TRANSFORMER

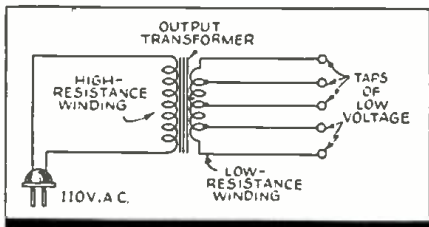

● SOMETIMES experimenters find a need for small filament transformers. These are hard to find in the ordinary junk box. An old universal output transformer, however, will do the job nicely. The transformer need not be of the "universal" type but it is preferred as the taps of the low-voltage winding will give you outputs ranging from 2 to 10 volts; and approximately 1 ampere.

To use the output transformer as a filament transformer the 110-V. A.C. line is connected to the high-resistance winding. The filament voltage will be taken from the "low" winding which is more commonly called the voice coil winding. The transformer connected this way can also be used for ringing doorbells and buzzers.

GEORGE PLATCO,  
Brockway, Pa.

"WEATHER 6" GIRLS GET "TUTOR" RECORDS

An innovation in training girls to handle the job of recording on steel-tape, in making recordings for the Bell Telephone Co.'s Weather Forecast service, is the use of phonograph records which demonstrate the perfect way to give a weather forecast bulletin, showing-up all the subtle problems in its delivery. This will enable the girls to listen over and over again, and study each point as much as they like. The recordings were made at the Bell Labs. by some of the weather service girls.

FREE! VERY LATEST PROFIT GUIDE Everything in RADIO! At the lowest prices!

**COMPLETE SELECTIONS GUARANTEED QUALITY**  
Faster Delivery  
Most complete stocks of Universal and Exact Duplicate Replacement and Repair Parts Radio Sets, and Amateur Supplies.  
**P. A. EQUIPMENT**  
Separate amplifiers or complete systems with any desired assortment of speakers, horns, baffles and microphones. Everything from 5 to 100 watts. Prices that save money for you.  
**ELECTRICAL APPLIANCES**  
Extra profits for you! Standard Brand Electric Irons, Grills, Toasters, Percolators, Waffle Irons, Vacuum Cleaners, Clocks, Mixers, etc., at lowest prices.

**MAIL THIS COUPON TODAY**  
The RADOLEK Co.  
601 W. Randolph St., Chicago, Dept. C-44  
Send the latest Radio Profit Guide FREE.  
Name .....  
Address ..... Dealer?.....  
Experimenter?..... Serviceman?..... Amateur?.....

**PATENTS—TRADE MARKS**  
Booklet concerning Inventions & Patents Form "Evidence of Conception" with instructions for use and Schedule of Government and Attorneys Fees—Free  
**LANCASTER, ALLWINE & ROMMEL**  
Registered Patent Attorneys  
436 Bowen Bldg. Washington, D. C.

**DATAPRINTS**  
TESLA-ODDIN HI-FREQ. COILS  
20c Ea. in order for 10 (Data and Drawings only.)  
36" Sp'k Tesla-Oudin Coil 40c (1 K.W. Exc. Trf. Data, included FREE!)  
8" Sp'k Tesla-Oudin Coil 40c (1/4 K.W. Exc. Trf. Data, included FREE!)  
3" Sp'k Oudin; 110 Vt. "Kick Coil" type.....40c  
3" Sp'k Tesla Works on Ford Sp'k Coil .....40c  
1" Sp'k Violetta Hi-Freq. Coil.....40c  
Model Warships—Get List of Plans

**Induction PIPE & ORE LOCATOR**  
Induction Type, Data .....40c  
Radio Type .....40c

**More DATAPRINTS 40c each!**  
5 Meter Superhet. Electric Refrigerator  
1/2 Meter Tr. & Rec. Resistance Measuring Bridge  
20 A.C. Probs. & Ans. Weld. Transf. 2 K.W.  
20 Telephone Hook-ups 100 Mech. Movements Rewing Armatures  
100 Mech. Movements String Galvanometer  
20 Motor Hook-ups 20 Simple Bell Circuits  
Television Hook-up Steel Wire Recorder!  
20 Elec. Party Traps —get list. Water Wheels or Turbines  
Solenoids and Magnets Fry Eggs on Ice! Photo Cell and Relay  
—get list. Experimental Photo- Ring 4 bells; 2 Wires  
phone 20 Tesla Tricks  
Radio Control for Models Polarized Relay  
Diathermy Apparatus Inductor Organ Induction Balance

Special Prices: 4 prints \$1.00; 10 for \$2.00; Single, 40c each. Get New Catalog 100 A.  
**The DATAPRINT Co.**  
Lock Box 322C, Ramsey, N. J.

# •BOOK REVIEWS•

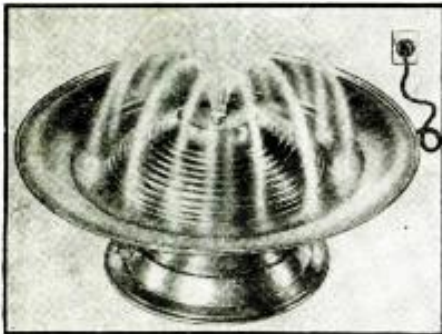

## Extra Profits for Radio Men Selling Electric Humidifiers

It doesn't take a salesman to sell this Humidifier. You can do it on a single demonstration. The unit talks for itself. This electric Fountain Humidifier is 14" in diameter and sprays into the air eight streams of water which rise 5" above fountain head and then fall back into the pond. The Humidifier is made of heavy spun aluminum (scratch-proof surface) and is available in five different attractive colors—Bronze, Chrome, Copper, Red and Green. No water connections are needed—merely plug into the 110-Volt, 60-Cycle A.C. line and turn the switch—no pipes, no rubber connections, no messy fittings. Complete evaporation does not damage the mechanism.

In winter, the Fountain Humidifier adds healthful moisture to the air, evaporating as much as a pint of water in 24 hours. In summer, it is a charming, useful attraction and provides the pleasant, trickling sounds of falling water which suggests comfort and coolness. A drop of perfume added to the water will diffuse any room odor. Operating cost is only a few cents monthly.

Price complete, ready to use, with a 6 ft. silicon cord and switch on case (F.O.B. N.Y.C.) shipping weight 9 lbs. **\$14.95**

Distributors, jobbers and dealers write for prices

**JOSEPH H. KRAUS COMPANY**  
123 Liberty Street New York, N. Y.

**JOSEPH H. KRAUS COMPANY**  
123 Liberty St., New York, N. Y.

Gentlemen: Enclosed you will find my remittance of \$14.95 for which ship me one ELECTRIC FOUNTAIN HUMIDIFIER (F. O. B., New York City). Send me details for:

- JOBBERS and DISTRIBUTORS  
 DEALERS and SERVICEMEN

Name .....

Address .....

City ..... State .....

(Remit by check or money order; register letter if you send cash) RC-840



## SWINGS INTO ACTION

Primarily the aim of the Association is to return to the Distributor, the Dealer and the Serviceman the profits which are legitimately HIS! This can only be accomplished by raising the standards of ethics of merchandising within the industry.

Names of Member Jobbers in your territory will be supplied if you will address the Executive Secretary of the Association.

**Office of the Executive Secretary**  
5 West 86th Street New York, N. Y.

**RADIO AT ULTRA-HIGH FREQUENCIES (1940).** Published by RCA Institutes Technical Press. Heavy paper cover, 6 x 9 ins., profusely illustrated, 456 pgs.

Frequency Modulation—today's No. 1 topic—is extensively discussed in the newest publication of RCA Institutes Technical Press. In "Radio at Ultra-High Frequencies" technical papers by RCA engineers also present the newest information on the propagation, relaying, measurement and reception of signals on frequencies above 30 megacycles.

The book is divided into 2 sections as follows: **PAPERS PUBLISHED IN FULL:** Part I—Ultra-high frequencies below 300 mc.; Part II—Ultra-high frequencies above 300 mc. **PAPERS PUBLISHED IN SUMMARY FORM:** Part I—Ultra-high frequencies below 300 mc.; Part II—Ultra-high frequencies above 300 mc.

We could go to great lengths in reviewing this book, pointing out in detail the important articles it contains on television, frequency and phase modulation, new transmitting and receiving tubes and the various other subjects of interest to short-wave specialists, but we would still fall short of conveying the importance of this book. We can only say it is a "must" for every advanced radio technician. Note that there is no price set on the volume and no copies are to be sold. Its sole distribution will be as a premium with the 3rd year of a new or old subscription to RCA Review (quarterly).

**NEW CONSTRUCTION BLUEPRINT SERIES. Construction Pattern Series, Folders Nos. 1 to 7, incl. Published by Technifax. Price, 50c each.**

This series of construction patterns is a set of blueprints that show how to make various types of metal locators or so-called treasure finders. The Patterns are complete with construction details, List of Parts and a 22 x 34 in. blueprint schematic diagram and construction working plan. The different Patterns are identified as follows: No. 1—"Radiosector Pilot"; No. 2—"Harmonic Frequency Locator"; No. 3—"Beat-Note Indicator"; No. 4—"Radio-Balance Surveyor"; No. 5—"Variable Inductance Monitor"; No. 6—"Hughes Inductance-Balance Explorer"; No. 7—"Radiodyne Prospector".

**FREQUENCY MODULATION.** by John F. Rider (1940). Published by John F. Rider Publisher, Inc. Size, 5½ x 8½ ins., cloth cover, profusely illustrated. Price, \$1.00.

Servicemen throughout the country are evincing exceptional interest in frequency modulation. For this reason, "FM—An Introduction to Frequency Modulation" should receive wide acceptance if only because it is the first published description in detail of frequency modulation as seen through the eyes of the Serviceman. This reviewer predicts Rider's newest book will be a sell-out.

The chapters cover: Frequency Modulation; What Happens at the Transmitter and Receiver; Transmission of F.M.; F.M. Receiving Antennas; and, Servicing F.M. Receivers.

For the theorist there is appended an amazingly extensive bibliography which should meet the needs of anyone who wishes additional information not strictly related to servicing.

**CENTRAL SOUND SYSTEMS FOR SCHOOLS (1940).** Published by Committee on Scientific Aids to Learning. Size, 6 x 9 ins., paper cover, illustrated, 69 pgs.

Here is a practical manual dealing with the installation of sound equipment in schools which the Serviceman and sound technician will find useful. Sound systems and components are described in sufficient detail as to enable sound men to readily apply the information to practically all makes of apparatus. Write for this publication on your company letterhead.

Table of Contents: The Functions of Central Sound Systems in Schools; Facilities Provided by Central Sound Systems; Technical Characteristics of Sound Systems; Sample Specifications for a School Sound System.

**THINGS A BOY CAN DO WITH CHEMISTRY.** by Alfred Morgan (1940). Published by D. Appleton-Century Co., Inc. Size 5½ x 8½ ins., cloth cover, profusely illustrated, 288 pgs. Price, \$2.50.

Radio and electronic experimenters will be particularly interested in at least 4 of the chapters in this book, viz.: The Two Great Divisions of Chemistry, Atoms and Molecules, Chemical Shorthand—The Tools of the Chemist; Metals, Alloys, Iron and Steel; Experiments with Metals; Electrochemistry.

Mr. Morgan is an old hand at making descriptions of things technical easy to read.

## Index to advertisers

### BROADCASTING

Radio Corp. of America..Inside Front Cover

### PUBLIC ADDRESS EQUIPMENT

Amplifier Co. of America.....85, 80, 100  
Atlas Sound Corporation.....102  
John Meek Industries.....97  
Miles Reproducer Co.....97  
Music Master Mfg. Co.....89  
RCA Mfg. Co., Inc.....97  
Wright-DeCoster, Inc.....102  
Wright, Inc.....100

### PUBLISHERS

Data Print Co.....127  
National Plans Inst.....67  
Radcraft Publications, Inc.....70, 120  
Radio & Technical Pub. Co.....68  
Supreme Publications.....100  
Technifax .....94, 119

### RADIO PARTS

Aerovox Corporation.....78  
Amperite Co.....79  
Hammarlund Mfg. Co.....83  
Illinois Condenser Co.....119  
National Carbon Company, Inc.....78  
Solar Mfg. Corp.....85  
Sprague Products Co.....89  
Thordarson Electric Mfg. Co.....84

### RADIO SETS

E. H. Scott Radio Lab., Inc.....69

### RADIO SUPPLY HOUSES

Allied Radio Corp.....119  
Burstin-Applebee Co.....100  
Hudson Specialties Co.....121  
Lafayette Radio Corp.....117  
Radolek Co.....127

### SCHOOLS

Capitol Radio Eng. Inst.....67  
Lincoln Engineering School.....67  
National Radio Institute.....65  
National Schools.....67  
New York YMCA Schools.....67  
Radio Training Assoc.....67  
RCA Institutes.....67  
Sprayberry Academy of Radio.....67

### TEST EQUIPMENT

Radio City Products Company....Back Cover  
Readrite Meter Works.....95  
Stuart, Allan.....122  
Superior Instruments Company.....Inside Back Cover  
Supreme Instruments Corp.....83  
Triplett Electrical Instruments.....79

### TUBES

Hygrade Sylvania Corp.....78  
National Union Radio Corp.....85

### MISCELLANEOUS

Classified Section.....118  
Joseph H. Kraus & Company.....128  
Lancaster, Allwine & Rommel.....127  
National Radio Parts Distributors Assoc.....128  
Radio Servicemen of America.....104  
Remington Rand, Inc.....109  
Victoria, Hotel.....84

(While every precaution is taken to insure accuracy, we cannot guarantee against the possibility of an occasional change or omission in the preparation of this index.)



Buy Direct From the Manufacturer and Save • Buy Direct From the Manufacturer and Save

Buy Direct From the Manufacturer and Save • Buy Direct From the Manufacturer and Save • Buy Direct From the Manufacturer and Save • Buy Direct From the Manufacturer and Save • Buy Direct From the Manufacturer and Save

## THE NEW MODEL 1230 SIGNAL GENERATOR

WITH 5 STEPS OF SINE-WAVE AUDIO



### SPECIFICATIONS:

1. Combination R.F. and A.F. Signal Generator. R.F.—100 K.C. to 90 Megacycles, A.F.—200 to 7500 cycles: Blue-Wave.—WITH OUTPUT OF OVER 1 VOLT. All direct reading, all by front panel switch manipulation.
2. R.F. and A.F. output independently obtainable, alone or with A.F. (any frequency) modulating R.F.
3. Latest design full-range attenuator used for controlling either the pure or modulated R.F.
4. Accuracy is within 1% on I.F. and broadcast bands; 2% on higher frequencies.
5. Giant dial etched directly on front panel, using a new mechanically perfected drive for perfect vernier control.
6. Operates on 90 to 130 V. A.C. or D.C. (any frequency).

The Model 1230 comes complete with tubes, shielded cables, molded carrying handle and instructions. Size 14"x6"x11". Shipping weight 15 pounds. Only **\$1285**

## THE NEW MODEL 1280 SET-TESTER

Combines Models 1240 and 1250



A complete testing laboratory in one unit, the Model 1280 combines the Models 1250 Multitester and 1240 Tube Tester. (See specifications of each below.)

- ★ Instantaneous Snap Switches Reduce Actual Testing Time to Absolute Minimum.
- ★ Spare Socket and Filament Voltages Up to 120 Volts, Make the Model 1280 Obsolescence Proof.
- ★ Latest Design  $4\frac{1}{2}$ " D'Arsonval Type Meter.
- ★ Works on 90 to 125 Volts 60 Cycles A.C.

Even those servicemen who through past purchases know they can always get SUPER-VALUES from Superior, will be amazed and delighted when they read the specifications of this all-purpose instrument and then note the unbelievably low price. The Model 1280 features a  $4\frac{1}{2}$ " D'Arsonval type meter for easy reading of the various scales, and in line with our new policy of stressing appearance as well as serviceability in our new 1200 line of test equipment, our Model 1280 utilizes an aluminum etched panel, designed for beauty as well as ruggedness. The primary function of an instrument is, of course, to make measurements accurately and when designing test equipment this is our first thought. However, we also appreciate the important part the appearance of an instrument plays in the impression a serviceman makes on his customers, especially on home calls. We have, therefore, paid special attention to the outward design of all of our new instruments. For instance, the panel of this Model 1280 is made of heavy-gauge aluminum and etched by a radically new process which results in a beautiful, confidence inspiring appearance.

Model 1280 comes complete with test leads, tabular data and instructions. Shipping weight 18 pounds. Size 13" x 11" x 6 $\frac{1}{2}$ ". Our net price .. **\$19<sup>95</sup>**

Portable cover \$1.00 additional

## THE NEW MODEL 1250 MULTITESTER



SLOPING PANEL FOR PRECISE RAPID SERVICING

Etched aluminum panel

Specially designed electronic rectifier enables linear A.C. scale, high stability and little or no temperature drift.

Here is an opportunity to acquire a Multi-Service, Precision Engineered Instrument, for less than you would have to pay for an ordinary Volt-Ohm Milliammeter. Besides making the usual volt, resistance and current measurements (both A.C. and D.C.) this unit accurately measures the CAPACITIES of mica, paper and electrolytic condensers, INDUCTANCE of coils, chokes and transformers, DECIBEL gain or loss, of power amplifiers and public address systems, WATTS output of amplifiers, receivers, etc.

### SPECIFICATIONS

- |   |  |
|---|--|
| Complete A.C. and D.C. Voltage and Current Ranges | High and Low Capacity Scales .0005 to 1 mfd. and .05 to 50 mfd.  |
| D.C. Voltage:—0-15, 0-150, 0-750 volts            | 3 Decibel Ranges   |
| A.C. Voltage:—0-15, 0-150, 0-750 volts            | - 10 to +19, - 10 to +38, - 10 to +53                            |
| D.C. Current:—0-1, 0-15, 0-150, 0-750 ma.         |  |
| A.C. Current:—0-15, 0-150, 0-750 ma.              | Inductance: 1 to 700 Henries                                     |
| 2 Resistance Ranges 0-500 ohms, 500-5 megohms     | Watts: Based on 6 mw. at O.D.B. in 500 ohms .006000 to 600 Watts |

Model 1250 works on 90-120 volts 60 cycles A.C. Comes complete with test leads, tabular charts and instructions. Shipping weight 9 lbs. Size 9 $\frac{1}{2}$ " x 11" x 6 $\frac{1}{2}$ ". Our net price .... **\$11<sup>85</sup>**

Portable cover \$1.00 additional

## THE NEW MODEL 1240 TUBE TESTER



Instantaneous snap switches reduce actual testing time to absolute minimum.

Tests all tubes 1.4 to 117 volts.

Sockets for all tubes—No adapters.

Superior is proud to offer the newest and most practical tube tester ever designed. Unbelievably low in price—unbelievably high in performance.

- ★ Tests all tubes 1.4 to 117 volts, including 1, 5, 6, 7, 7L, octals, 40-pins, Hamam Jr., Peanod, single ended, filament, Mercury Vapor rectifiers, the new S series. In fact every tube designed to date.
- ★ Spare socket included on front panel for any future tubes.
- ★ Tests by the well-established emission method for tube quality, directly read on the GOOD ? BAD scale of the meter.
- ★ Jewel protected neon.
- ★ Tests shorts and leakages up to 2 megohms in all tubes.
- ★ Tests leakages and shorts in all elements AGAINST all elements in all tubes.
- ★ Tests BOTH plates in rectifiers.
- ★ Tests individual sections such as diodes, triodes, pentodes, etc., in multi-purpose tubes.
- ★ Latest type voltage regulator.
- ★ Features an attractive etched aluminum panel.
- ★ Works on 90 to 125 volts 60 cycles A.C.

Model 1240 comes complete with instructions and tabular data for every known type of receiving tube. Shipping weight 12 pounds. Size 6" x 7 $\frac{1}{2}$ " x 10 $\frac{1}{2}$ ". Our Net Price..... **\$11<sup>85</sup>**

Portable cover \$1.00 additional

# SUPERIOR INSTRUMENTS CO. 136 LIBERTY ST., DEPT. RC8 NEW YORK, N. Y.

Buy Direct From the Manufacturer and Save • Buy Direct From the Manufacturer and Save



# 4 times the proof that its RCP Test Equipment FOR BIG VALUE AT LOW COST!

## TUBE TESTER-SET ANALYZER Model 801M

WHERE COULD YOU BUY these two essential instruments individually, and get the same high quality—at the same low price? And RCP has added, at no extra cost, miniature tube testing and self-contained battery power supply (for ohmmeter range below 1 megohm)—new features built on the basic advantages owners have long enjoyed in Combination Model 801. Here's the biggest test instrument value low price ever bought! Model 801 has every worthwhile modern feature . . . and it opens a whole new era in test equipment profit. Extra-money-making features like these make RCP Combination Model 801 something to see your nearest jobber about TODAY—

- Meter is fused—line is double fused
- Tests all new and old tubes . . . all ballast tubes
- Noise test . . . meter reversing switch
- AC voltage measurements have linear scales to coincide with DC
- DC voltmeter 0/10/50/500/1000 ohms per volt
- New miniature tube tests
- Four range AC voltmeter 0/10/50/500/1000
- DC milliammeter 0/1/10/100/1000
- DC Ammeter 0/10
- Ohmmeter 0 500/5000/1,000,000/10,000,000—built-in power supply.
- D. B. Meter—8—15/15 to 29/29 to 49/32 to 55 decibels

RCP MODEL 801 **\$27.95**



## Famous DYNOPTIMUM TUBE TESTER

### MODEL 308

Tests all new miniature tubes . . . all ballast tubes. Noise and hum test for tubes showing otherwise good. Sensitive neon tests for shorts and leaks. Spare socket for future tube developments. Checks pilot lights, headlights, miniature lights. Rapid, accurate. Individual check of sections of rectifiers and multi-purpose tubes. It's Tomorrow's Tube Checker today! . . . amazingly versatile, handsomely finished, sensationally low-priced!



Counter Type Model 308 **\$16.95**  
Combination Portable—  
Counter Type Model 308P **\$18.95**

## SIGNAL GENERATOR MODEL 702

An even finer performing test instrument than RCP's famous former Signal Generator, and it costs 30% less! All latest improvements in circuit and mechanical design. Extremely wide all-wave coverage continuously variable from 95 Kilocycles to 100 Megacycles. Output modulated at will. 30% modulation at 400 cycles, sine wave from self-contained independent 400 cycle circuit. Attenuation in approximate microvolt calibration by means of five step ladder attenuators. Highly attractive appearance.



**\$22.95**

## AC-DC MULTITESTER MODEL 445

It's in a class with testers selling at twice the price! Actually, it is the equivalent of 25 different instruments. D'Arsonval meter accurate within 2%. DC voltmeter 0/5/50/250/500/2500. DC Ammeter 0/10. AC voltmeter 0/10/100/500/1000. Three range ohmmeter 0 500/100,000/1 Meg. Meter sensitivity 1 Milliampere or 1000 ohms per volt. Selector switch operated, complete with batteries.



**\$9.95**

**SEE YOUR JOBBER OR** if he cannot supply you with the RCP Test Instrument you desire, write to us direct (penny postcard) for new catalog describing the complete RCP BIG VALUE—Low Cost Test Equipment Line.

# RADIO CITY

PRODUCTS CO. INC.  
88 PARK PLACE, N. Y. C.